

PART NUMBER: MES9

DESCRIPTION: incremental encoder

ELECTRICAL SPECIFICATIONS

output waveform	Square Wave
output signals	A, B, Z phase
current consumption	≤40 mA
frequency response	0~100 KHz
output phase difference	A, B phase difference 90° ± 45° (T/4±T/8) Z phase T±T/2 (see output waveform)
supply voltage	5 V dc ± 10%
output resolution (ppr)	100, 200, 256, 300, 360, 500, 1000
waveform rise/fall time	2μ or less (output cable 140mm or less)

MECHANICAL SPECIFICATIONS

max shaft load,	radial:	1.9N (200gf)	0.98N (100gf) (1000 ppr)
	axial:	1.9N (200gf)	0.98N (100gf) (1000 ppr)
starting torque		1 x 10 ⁻³ N·m (10 gf·cm)	
max rotational speed		6000 RPM	
shock resistance		500 m/s ² (50G), 3 times each on XYZ	
vibration proof		55 Hz, double amplitude 1.5mm, 2 hours each on XYZ	
weight		10g (with 140mm cable)	
cable		Vinyl wire (AWG30) cable length 140mm	

ENVIRONMENTAL SPECIFICATIONS

operating temp	0° to +60° C
storage temp	-20° to +80° C
humidity	RH 35%~90% non collecting

ORDERING INSTRUCTIONS

MES9 - XXXPX

Resolution (PPR):
 100 = 100PPR 300 = 300 PPR
 200 = 200PPR 360 = 360 PPR
 256 = 256PPR 500 = 500 PPR
 1000 = 1000 PPR

Output Circuit:
 "no entry" = TTL voltage output
 C = Open collector output

PART NUMBER: MES9

DESCRIPTION: incremental encoder

CIRCUIT CONNECTIONS

Voltage Output

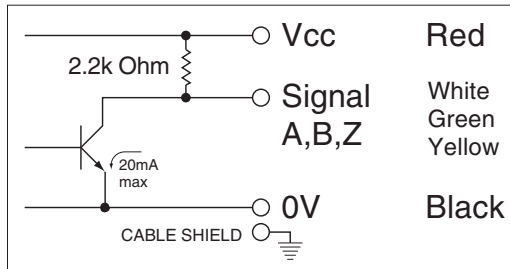

Open Collector Output

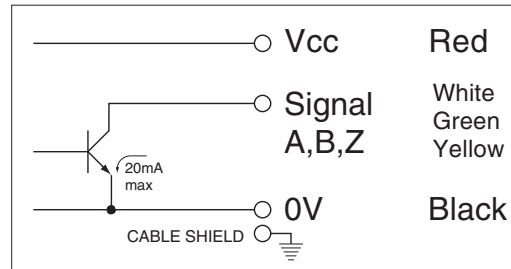

OUTPUT WAVEFORM

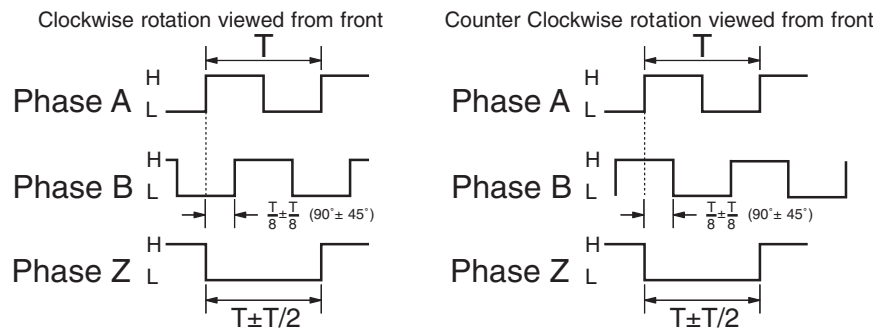

The position of Z phase against A, B phase is not specified

REV.	DESCRIPTION	DATE
A	NEW DRAWING	7/27/2007

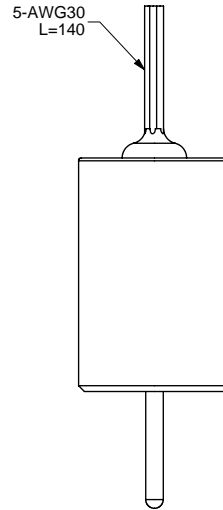
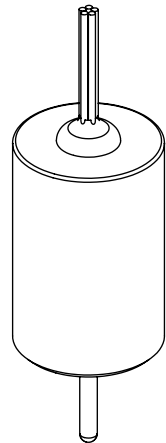
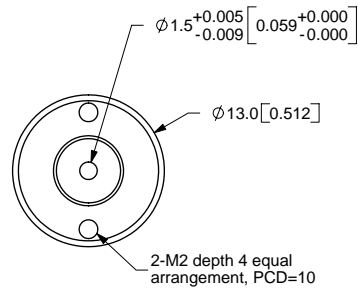
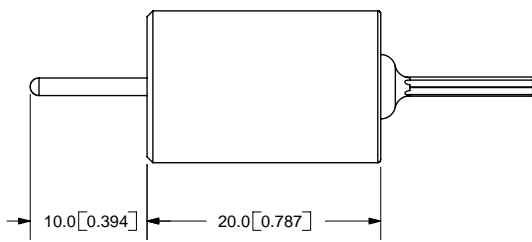

TOLERANCE:
±0.3mm UNLESS OTHERWISE
SPECIFIED



CUI INC

20050 SW 112th Ave.
Tualatin, OR 97062
Phone: 503-612-2300
800-275-4899
Fax: 503-612-2383
Website: www.cui.com

TITLE: Incremental Encoder		REV: A
PART NO. MES9	UNITS: MM [INCHES]	
DRAWN BY: JMS	APPROVED BY:	SCALE: 2:1

PC FILE NAME:
MES9

COPYRIGHT 2007
BY CUI INC.

Cable Color	Red	White	Green	Yellow	Black	-	-	-
Output Type	Power	A-Phase	B-Phase	Z-Phase	0V	-	-	-