



TS1084

5A Low Dropout Positive Voltage Regulator

TO-220



TO-263



TO-252



Pin assignment:

1. Ground / Adj
2. Output
3. Input

Low Dropout Voltage 1.3V max.

General Description

The TS1084 Series are high performance positive voltage regulators are designed for use in applications requiring low dropout performance at full rated current, Additionally, the PJ1084 Series provides excellent regulation over variations due to changes in line, load and temperature. Outstanding features include low dropout performance at rated current, fast transient response, internal current limiting and thermal shutdown protection of the output device. The TS1084 Series are three terminal regulators with fixed and adjustable voltage options available in popular packages.

This series is offered in 3-pin TO-263, TO-220 and TO-252 package.

Features

- ✧ Low dropout performance 1.3V max.
- ✧ Full current rating over line and temperature.
- ✧ Fast transient response
- ✧ $\pm 2\%$ Total output regulation over line, load and temperature
- ✧ Adjust pin current max 90 μ A over temperature
- ✧ Line regulation typical 0.015%.
- ✧ Load regulation typical 0.05%.
- ✧ Fixed/adjustable output voltage
- ✧ TO-220, TO-263 and TO-252 package

Block Diagram

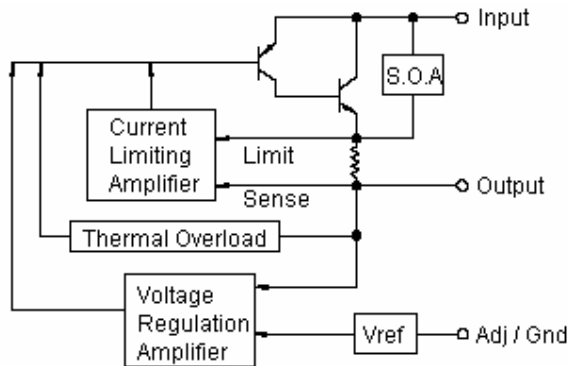

Ordering Information

Part No.	Operating Temp. (Ambient)	Package
TS1084CZ-xx	-20 ~ +85 °C	TO-220
TS1084CM-xx		TO-263
TS1084CP-xx		TO-252

Note: Where xx denotes voltage option, available are 5.0V, 3.3V and 2.5V. Leave blank for adjustable version. Contact factory for additional voltage options.

Absolute Maximum Rating

Input Supply Voltage	V _{in}	12	V
Operation Input Supply Voltage	V _{in (operate)}	7	V
Power Dissipation	P _D	Internally Limited	W
Operating Junction Temperature Range	T _J	-25 ~ +150	°C
Storage Temperature Range	T _{STG}	-65 ~ +150	°C
Lead Soldering Temperature (260 °C)			
TO-220 / TO-263 Package		10	S
TO-252 Package		5	



Electrical Characteristics					
Ta = 25 °C, unless otherwise specified. Adjustable version test with Vout = 2.5V.					
Parameter	Conditions	Min	Typ	Max	Unit
Output Voltage	Vout+1.5V ≤ Vin ≤ 7V, Io=10mA	0.990 Vo	5.0 / 3.3	1.010 Vo	V
	Vout+1.5V ≤ Vin ≤ 7V, Io=5A	0.980 Vo	2.5	1.020 Vo	V
Reference Voltage	(Vin-out) =1.5V, Io=10mA	0.990 Vo	1.25	1.010 Vo	V
	(Vin-out) =1.5V, Io=5A	0.980 Vo		1.020 Vo	V
Input Supply Voltage		--	--	7	V
Line Regulation	Vout+1.5V ≤ Vin ≤ 7V, Io=10mA	--	0.015	0.2	%
Load Regulation (note 1,2)	Vin=Vout+1.5V, 10mA ≤ Io ≤ 5A	--	0.05	1.0	%
					%
Dropout Voltage	Io=5A, ΔVout=0.1%Vout	--	1.2	1.3	V
Minimum Load Current	Vin=5V	--	8	10	mA
Adjustable Pin Current		--	90	--	uA
Current Limit	Vin - Vout=3V	5.5	--	--	A
Temperature Stability	Io=10mA	--	0.5	--	%
Ripple Rejection	F = 120Hz, Io=5A Cout=25uF, Vin=Vout + 3V	--	60	70	dB

Thermal Performance			
Condition	Package type	Typ	Unit
Thermal Resistance Junction to Ambient	TO-220	45	°C/W
	TO-263	45	
	TO-252	80	

Note 1: See thermal regulation specification for changes in output voltage due to heating effects. Line and load regulation are measured at a constant junction temperature by low duty cycle pulse testing. Load regulation is measured at the output lead = 1/18" from the package.

Note 2: Line and load regulation are guaranteed up to the maximum power dissipation of 15W. Power dissipation is determined by the input / output voltage difference and the output current. Guaranteed maximum power dissipation will not be available over the full input / output voltage range.

Note 3: Quiescent current is defined as the minimum output current required to maintain the regulation.

Typical Application Circuit

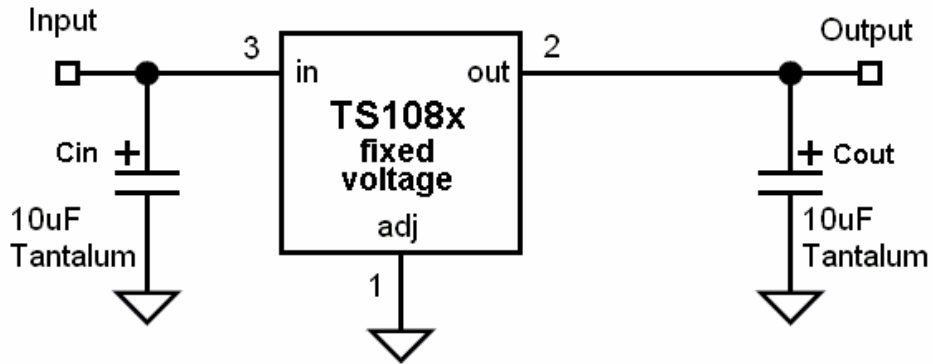

Fixed output voltage version

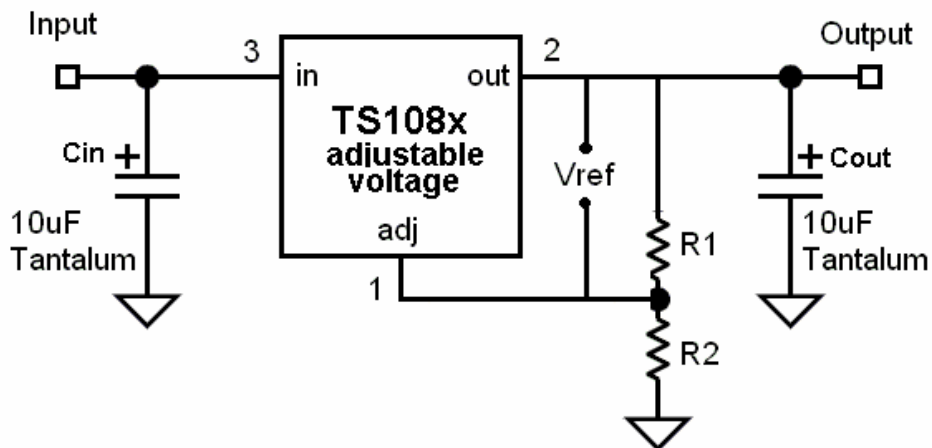

$$V_{out} = V_{ref} * (1 + R2 / R1)$$

* C_{in} is requested if regulator is located Far from power supply filter

** Design C_{out} as close to V_{out} pin as possible

Adjustable output voltage version

Electrical Characteristics Curve

Figure 1: dropout voltage v.s. output current

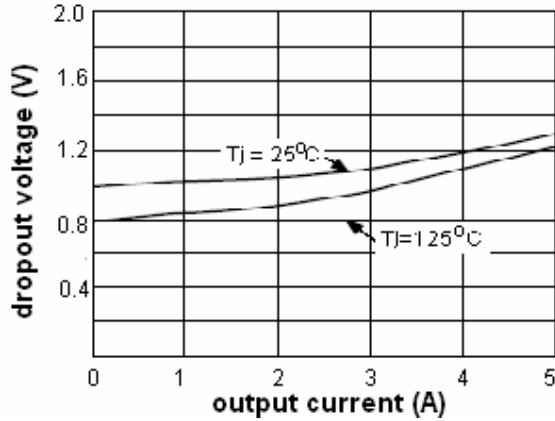

Figure 2: load regulation v.s. temp.

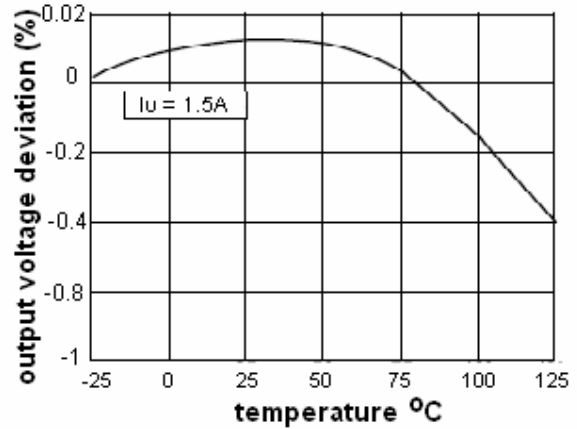

Figure 3: output change v.s. temp.

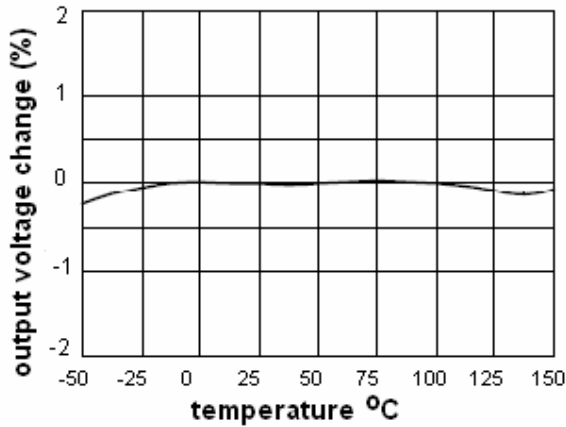

Figure 4: line regulation

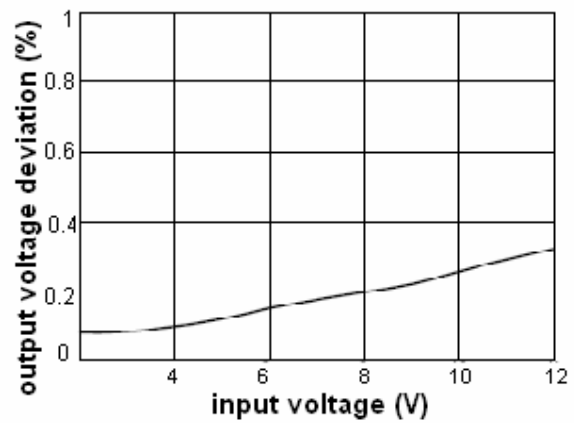

Figure 5: line transient response

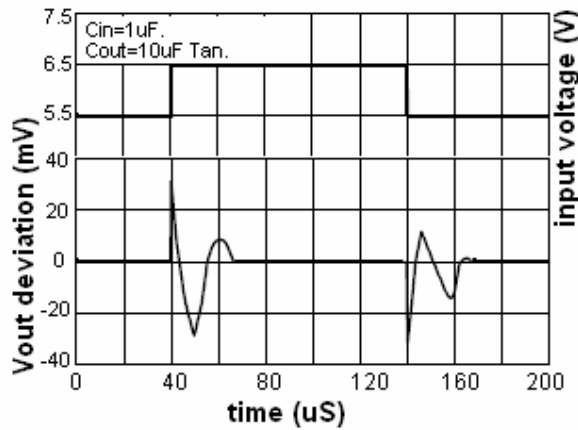
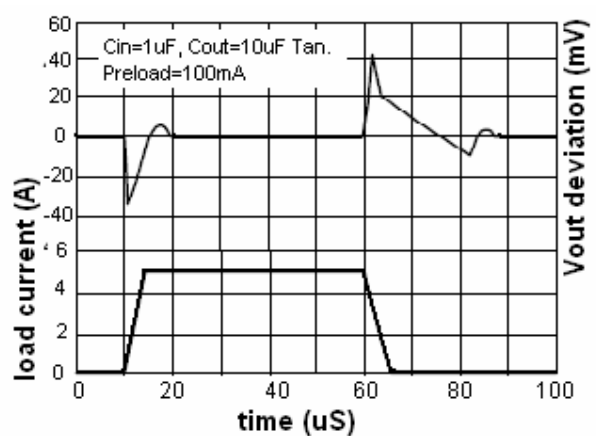
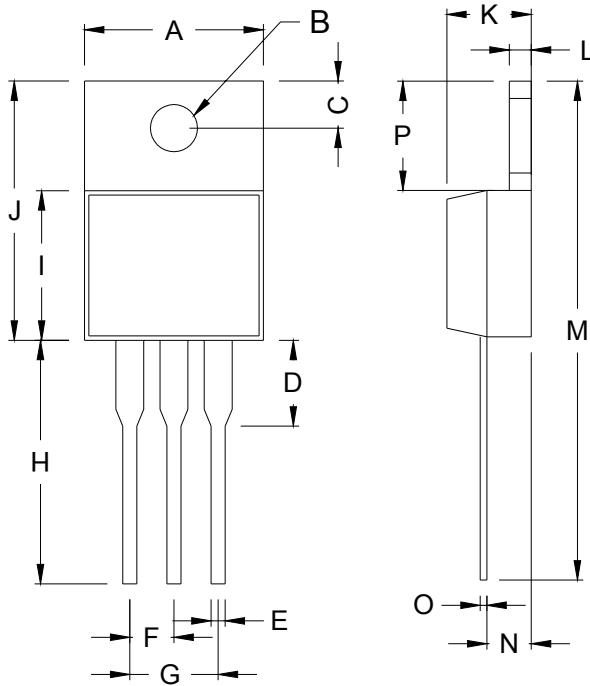

Figure 6: load transient response



TO-220 Mechanical Drawing



TO-220 DIMENSION				
DIM	MILLIMETERS		INCHES	
	MIN	MAX	MIN	MAX
A	10.000	10.500	0.394	0.413
B	3.240	4.440	0.128	0.175
C	2.440	2.940	0.096	0.116
D	-	6.350	-	0.250
E	0.381	1.106	0.015	0.040
F	2.345	2.715	0.092	0.058
G	4.690	5.430	0.092	0.107
H	12.700	14.732	0.500	0.581
I	8.382	9.017	0.330	0.355
J	14.224	16.510	0.560	0.650
K	3.556	4.826	0.140	0.190
L	0.508	1.397	0.020	0.055
M	27.700	29.620	1.060	1.230
N	2.032	2.921	0.080	0.115
O	0.255	0.610	0.010	0.024
P	5.842	6.858	0.230	0.270

TO-263 Mechanical Drawing

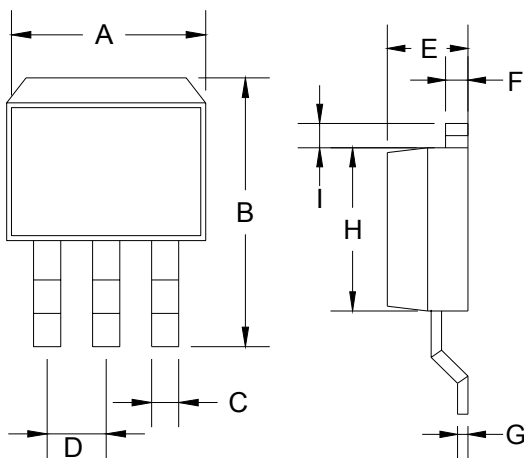

TO-263 DIMENSION				
DIM	MILLIMETERS		INCHES	
	MIN	MAX	MIN	MAX
A	10.000	10.500	0.394	0.413
B	14.605	15.875	0.575	0.625
C	0.508	0.991	0.020	0.039
D	2.420	2.660	0.095	0.105
E	4.064	4.830	0.160	0.190
F	1.118	1.400	0.045	0.055
G	0.450	0.730	0.018	0.029
H	8.280	8.800	0.325	0.346
I	1.140	1.400	0.044	0.055
J	1.480	1.520	0.058	0.060

TO-252 Mechanical Drawing

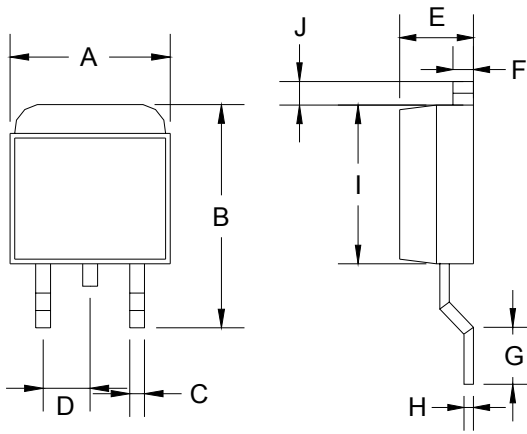

DIM	TO-252 DIMENSION			
	MILLIMETERS		INCHES	
	MIN	MAX	MIN	MAX
A	6.570	6.840	0.259	0.269
B	9.250	10.400	0.364	0.409
C	0.550	0.700	0.022	0.028
D	2.560	2.670	0.101	0.105
E	2.300	2.390	0.090	0.094
F	0.490	0.570	0.019	0.022
G	1.460	1.580	0.057	0.062
H	0.520	0.570	0.020	0.022
I	5.340	5.550	0.210	0.219
J	1.460	1.640	0.057	0.065