

400-mA Smart Regulator for Network Interface Card

FEATURES

- Single Fixed 3.3-V Output
- Linear Regulator for Dual Power Inputs
- Auxilliary Input Can Be Bypassed
- Automatically Switches Between Linear Regulator and Bypass Mode
- Linear Regulator: 3.3-V $\pm 3\%$ Output at 400-mA Current
- Linear Regulator: 600-mA Peak Output Current
- Low Bypass Switch Drop: $<55\text{-mV}$ Drop at 150 mA
- Built-in Short Circuit and Thermal Shutdown Protection

- Low Supply Current
- SOIC-8 Package

APPLICATIONS

- Network Interface Cards (NIC)
- PCMCIA Cards
- Cardbus
- Desktop Computers/Workstations

DESCRIPTION

The Si91860 provides a constant 3.3-V output with multiple inputs. This function is required in many power interface applications, such as the Network Interface Card (NIC). The Si91860 is offered in small SOIC-8 package with up to 2-W Power handling capability. The complete application circuit uses only four external components.

The PCI Card has a 3.3-V Chipset while the PCI bus has two independent 5-V sources. When needed, the two 5-V sources are available from the PCI bus or directly from the motherboard—normally $5 V_{IN}$ and standby $5 V_{SB}$. The internal regulator steps down from either of the 5-V supplies

to 3.3 V. A 200-m Ω power switch is integrated to connect the $3.3\text{-}V_{AUX}$ input to the output. The power drawn priority is $5 V_{IN} > 5 V_{SB} > 3.3 V_{AUX}$, where the selection is done internally and automatically by the Si91860. The power handling capability is as such as to carry at least 400-mA continuous load current for any power input condition.

In order to satisfy the stringent ambient temperature requirements in many applications, the Si91860 is rated for the industrial temperature range of -40°C to 85°C .

The Si91860 is available in both standard and lead (Pb)-free packages.

FUNCTIONAL BLOCK DIAGRAM

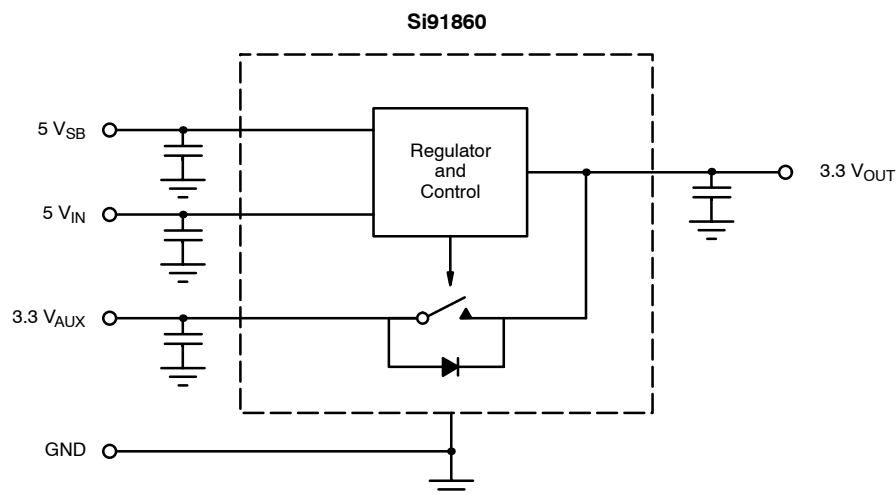

ABSOLUTE MAXIMUM RATINGS

Pin 1, 2, 4 Voltage	-0.3 V to 6 V
Linear Regulator Output Current (peak)	600 mA
Bypass Output Current	600 mA
Maximum Junction Temperature, $T_{J(max)}$	150°C
Storage Temperature, T_{STG}	-55°C to 150°C
ESD (Human Body Model)	2 kV

Package Power Dissipation ^b	
P_D	2W (internally limited via thermal shutdown)
Thermal Impedance (θ_{JA}) ^a	62.5°C/W

Notes

- Device mounted with all leads soldered or welded to PC board.
- Derate 16 mW/°C above $T_A = 25^\circ\text{C}$

Stresses beyond those listed under "Absolute Maximum Ratings" may cause permanent damage to the device. These are stress ratings only, and functional operation of the device at these or any other conditions beyond those indicated in the operational sections of the specifications is not implied. Exposure to absolute maximum rating conditions for extended periods may affect device reliability.

RECOMMENDED OPERATING RANGE

5- V_{IN} and 5- V_{SB} Pin Voltage	4.5 V to 5.5 V
3.3- V_{AUX} Voltage	3 V to 3.6 V

Load Range	1 mA to 400 mA
Operating Ambient Temperature, T_A	-40°C to 85°C

SPECIFICATIONS								
Parameter	Symbol	Test Conditions Unless Otherwise Specified 5 $V_{IN} = 5 V_{SB} = 5 V$, 3 $V_{AUX} = 3.30 V$ $I_{OUT} = 1 mA$, $C_{IN} = 4.7 \mu F$, $C_{OUT} = 2.2 \mu F$	Temp ^a	Limits -40 to 85°C			Unit	
				Min ^b	Typ ^c	Max ^b		
Regulator Mode								
Output Voltage (Regulator)	$V_{O(LDO)}$	0 mA < I_{OUT} < 400 mA, 4.5 V < 5 V_{IN} 5 $V_{SB} < 5.5 V$	Full	3.201	3.3	3.399	V	
5 V_{IN} Select		Rising Edge of Hysteresis	Threshold	Full		4.30	4.475	
			Hysteresis	Full		230		mV
5 V_{SB} Select			Threshold	Full		4.30	4.475	V
			Hysteresis	Full		230		mV
Ground Pin Current In Regulator MODE ^d	I_{GND}	$I_O = 0 mA$	Full		0.3	0.8	mA	
		$I_O = 400 mA$	Full		0.7	1.6		
Peak Output Current (Regulator)	I_O	$t_{PW} = 2 ms$	Full	600				
Output Noise Voltage (Regulator)	e_N	BW = 50 Hz to 100 kHz, $I_{OUT} = 150 mA$	Room		300		$\mu V_{(rms)}$	
Ripple Rejection (Regulator)	$\Delta 3.3 V_{OUT} / \Delta 5 V_{IN}$	$I_{OUT} = 150 mA$	1 kHz	Room		60	dB	
			10 kHz	Room		40		
			100 kHz	Room		30		
Dynamic Line Regulation	$\Delta V_{O(line)}$	$V_{IN}: 4.5 V \text{ to } 5.5 V$ $t_R/t_F = 2 \mu s$, $I_{OUT} = 150 mA$	Room		10		mV	
Dynamic Load Regulation	$\Delta V_{O(load)}$	$I_{OUT}: 1 mA \text{ to } 150 mA$, $t_R/t_F = 2 \mu s$	Room		20			
V_{OUT} Turn-On-Time	t_{ON}		Room		15		μs	
Thermal Shutdown Junction Temperature	$T_{J(s/d)}$		Full		165		°C	
Thermal Hysteresis	T_{HYST}		Full		20			
Short Circuit Current	I_{SC}	3.3 $V_{OUT} = 0 V$	Room		900		mA	
Bypass Mode (5 $V_{IN} = 5 V_{SB} = GND$)								
Output Voltage	$V_{O(BP)}$	0 mA < I_{OUT} < 150 mA	Full	3.247			V	
Bypass Switch On-Resistance	$r_{DS(on)}$	3.0 V $\leq V_{AUX} \leq 3.6 V$	Full		0.2	0.35	Ω	
Ground Current ^d	I_{GND}	0 mA < I_{OUT} < 400 mA	Full		200	400	μA	

Notes

- Room = 25°C, Full = -40 to 85°C.
- The algebraic convention whereby the most negative value is a minimum and the most positive a maximum.
- Typical values are for DESIGN AID ONLY, not guaranteed nor subject to production testing. Typical values at 25°C ambient.
- Ground pin current includes the IC supply current and the current to drive the linear regulator or bypass switch.

TIMING WAVEFORMS

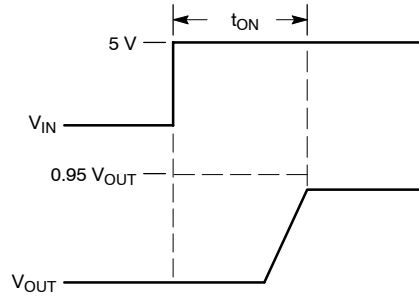
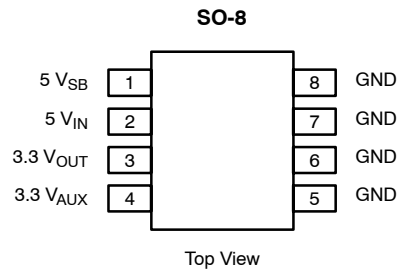

FIGURE 1. Timing Diagram

PIN CONFIGURATION



PIN DESCRIPTION		
Pin Number	Name	Function
1	5 V _{SB}	Secondary power input for the Regulator
2	5 V _{IN}	Primary power input for the Regulator
3	3.3 V _{OUT}	Output 3.3 V
4	3.3 V _{AUX}	Power input for the bypass function
5, 6, 7, 8	GND	Grounds



ORDERING INFORMATION		
Part Number	Temperature Range	Package
Si91860DY-T1	-40 to 85°C	Tape and Reel
Si91860DY-T1—E3		
Si91860DY		Bulk

Eval Kit	Temperature Range	Board Type
Si91860DB	-40 to 85°C	Surface Mount

TYPICAL CHARACTERISTICS

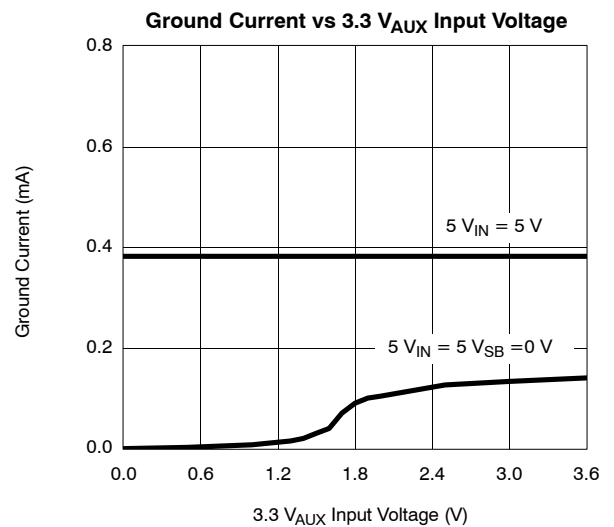
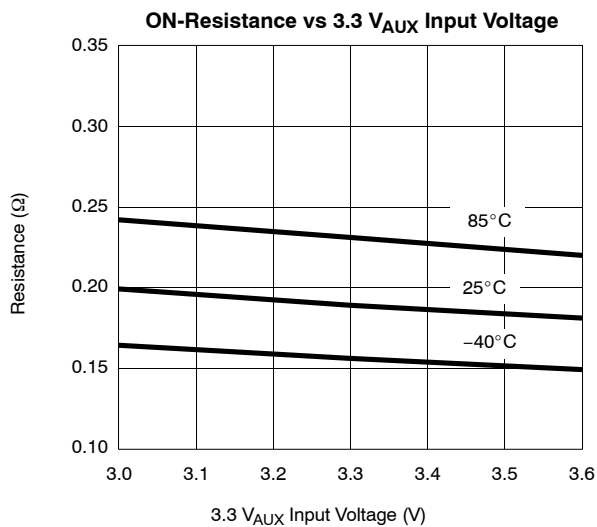
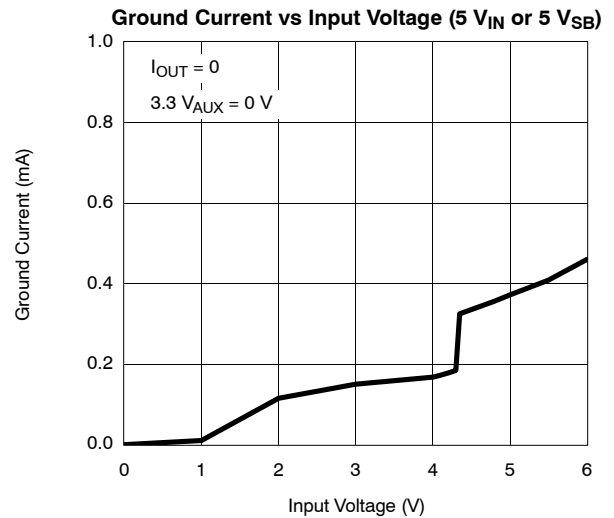
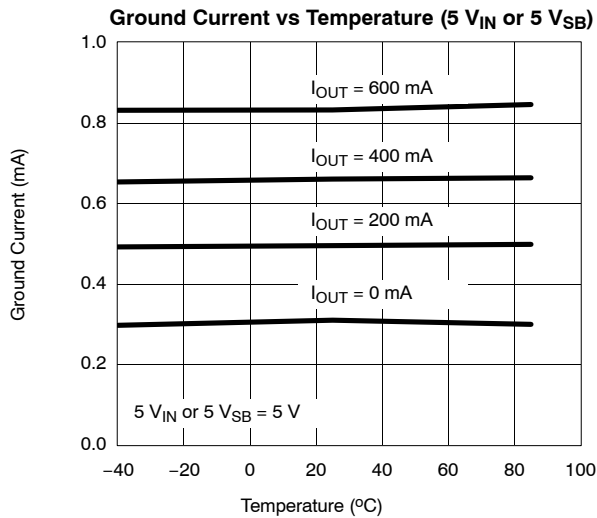

TYPICAL WAVEFORMS

Load Transient Response-1

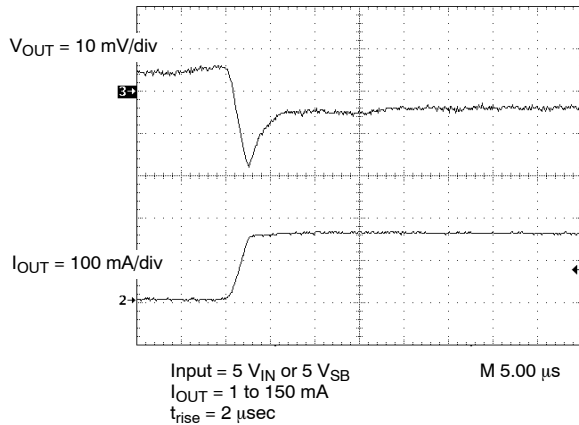

Load Transient Response-2

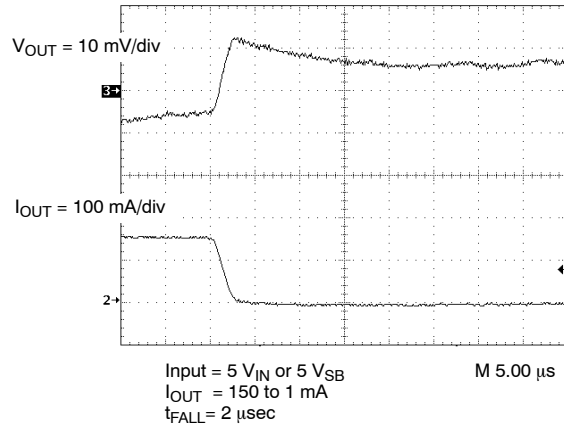

Load Transient Response-3

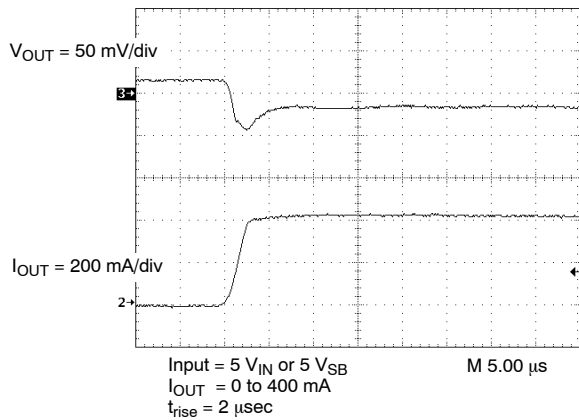

Load Transient Response-4

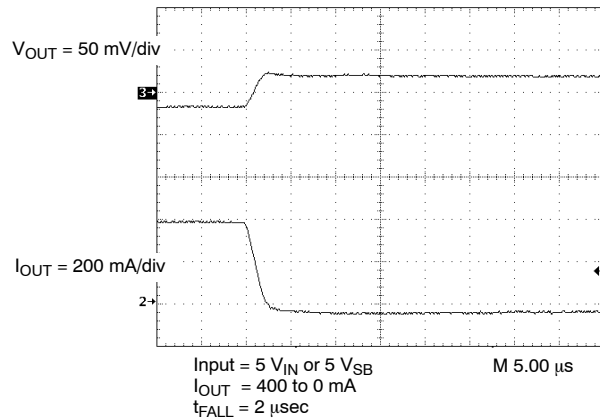

5 VIN Power Up ($5 V_{SB} = 5 \text{ V}$)

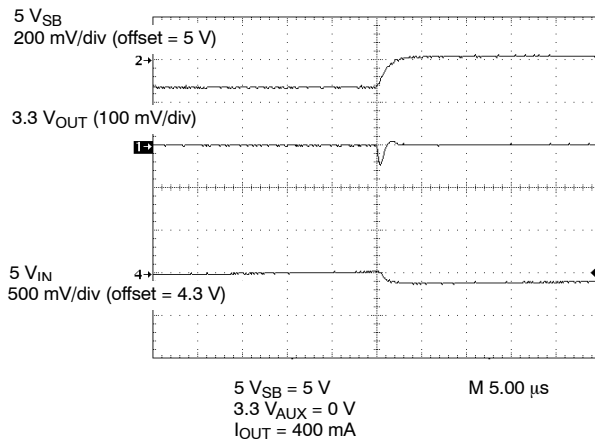

5 VIN Power Down ($5 V_{SB} = 5 \text{ V}$)

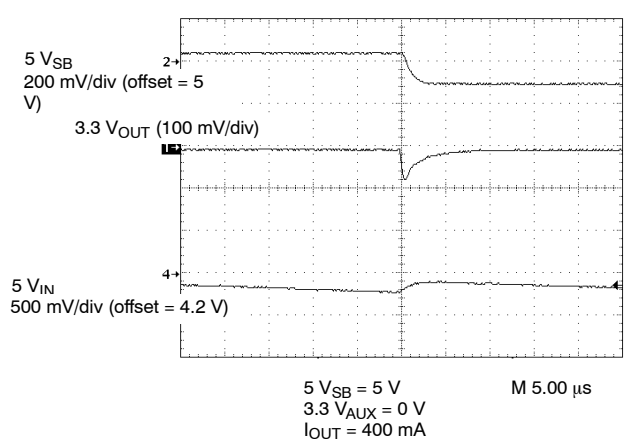



TYPICAL WAVEFORMS

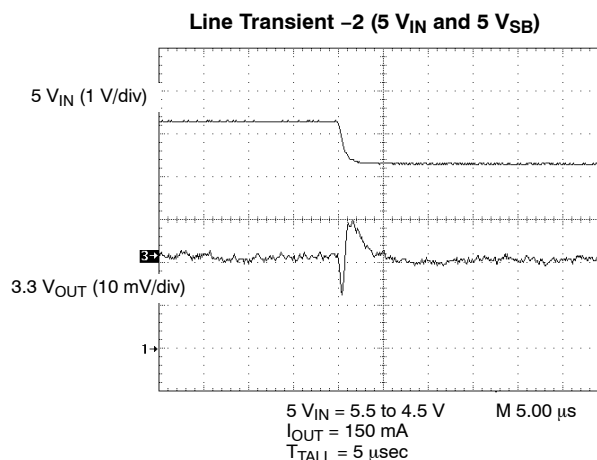
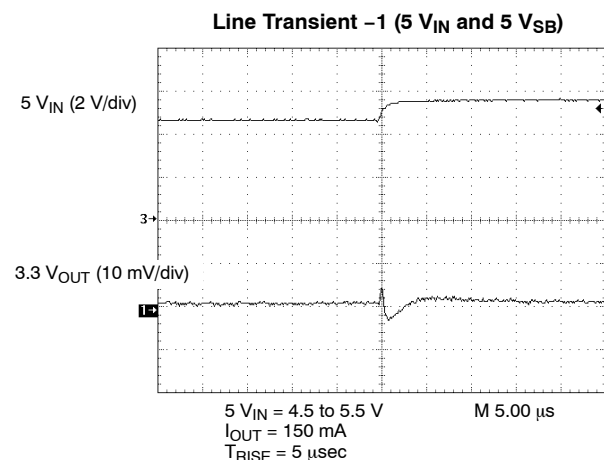
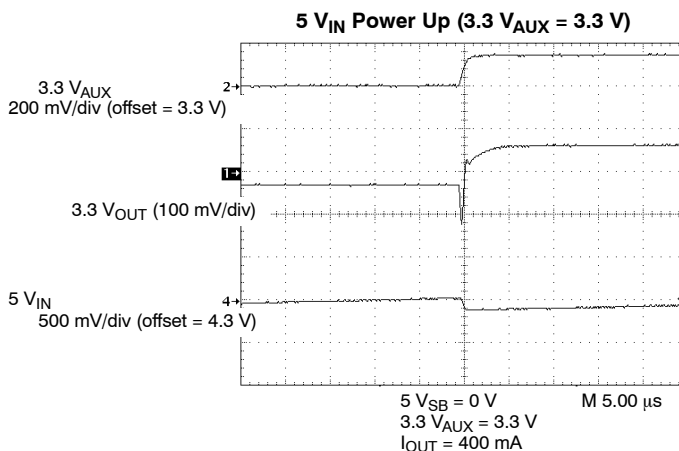
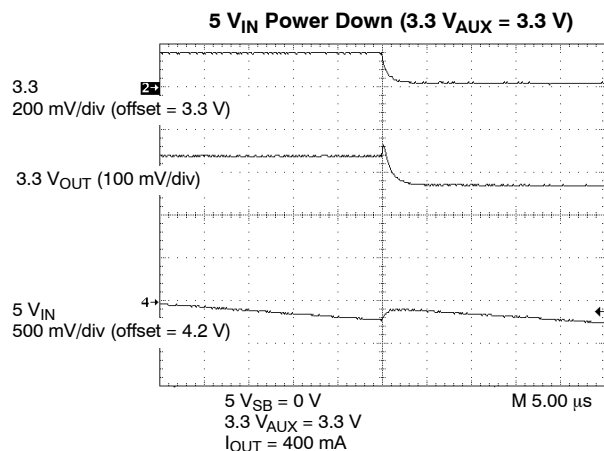

Power Supply Ripple Rejection vs. Frequency

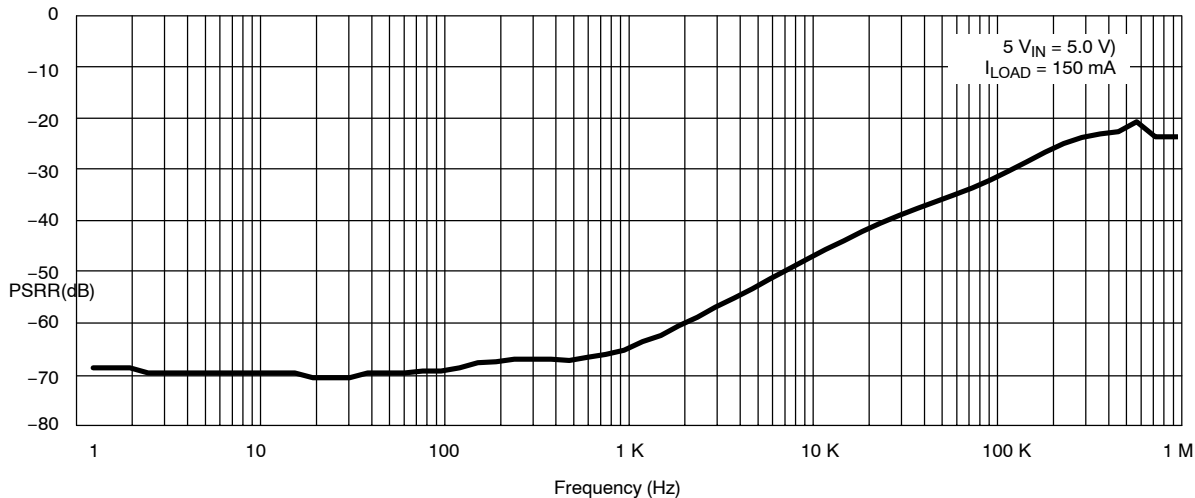

PSRR

BLOCK DIAGRAMS AND TYPICAL APPLICATION CIRCUIT

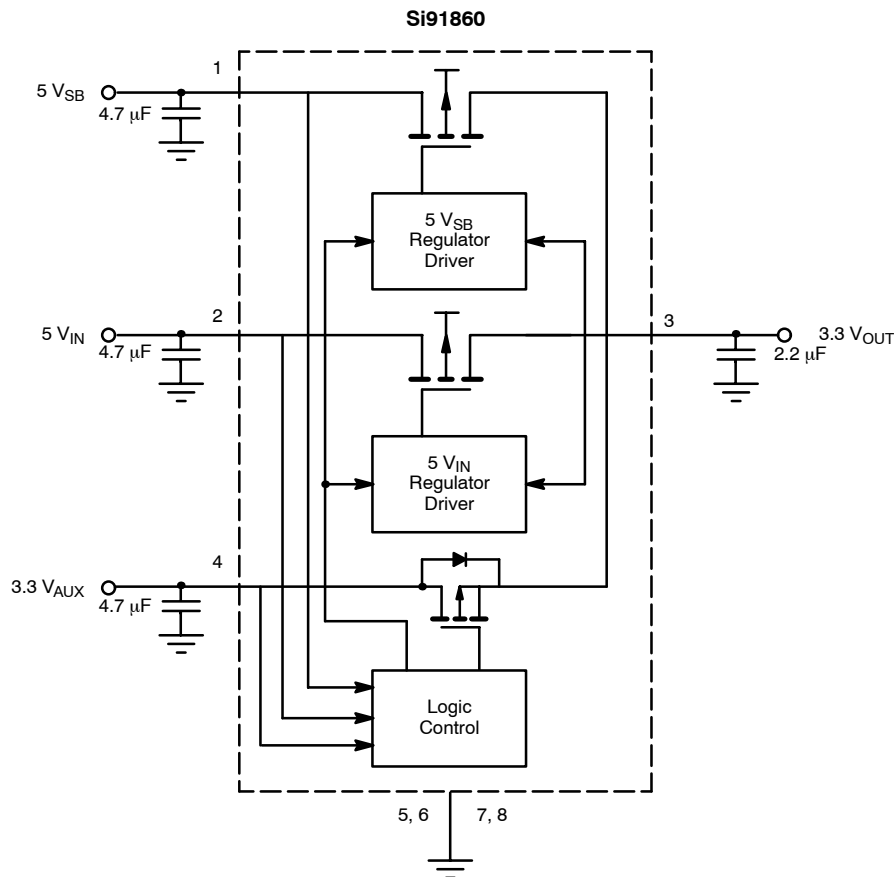

DETAIL DESCRIPTION

During normal operation, the 5- V_{IN} input powers the fixed 3.3-V output ($3.3 V_{OUT}$) through an internal linear regulator. When 5 V_{IN} falls below 4.07 V, the 3.3-V output is powered through the linear regulator from 5 V_{SB} . If both 5 V_{IN} and 5 V_{SB} are below 4.07 V, then the output ($3.3 V_{OUT}$) is powered from 3.3- V_{AUX} input. The power drawn sequence is from 5 V_{IN} , then 5 V_{SB} and lastly 3.3 V_{AUX} . If both 5 V_{IN} and 5 V_{SB} are above 4.30 V, then 5 V_{IN} will power the output. The device prevents reverse current from flowing from the output to any unbiased or low voltage input.

Linear Regulator Mode

The output is regulated at 3.3 V when either one of the 5- V_{IN} or 5- V_{SB} pins is more than 4.30 V. The 5 V_{IN} takes precedence when both the 5- V_{IN} and 5- V_{SB} pins are more than valid threshold voltage (i.e. > 4.30 V). The linear regulator will regulate the output until both the 5- V_{IN} and 5- V_{SB} pins fall below 4.07 V.

Bypass Mode

When both the 5- V_{IN} and 5- V_{SB} pins fall below 4.07 V, the output is powered by 3.3 V_{AUX} through a 0.2- Ω internal switch.

Thermal and Over-current Protection

Thermal protection limits total power dissipation in the device. It safeguards the device in the event of fault conditions. When the junction temperature exceeds 165°C, the device turns off. The device turns back on once its junction temperature cools down by approximately 20°C. The device has overcurrent protection (typically at 900 mA) when it operates in linear regulator mode. A continuous short at output pin ($3.3 V_{OUT}$) will result in a pulsed output as the thermal protection circuitry cycles the device on and off. For continuous operation, do not exceed the junction rating of 150°C. In bypass mode, the device is not current limited.



Disclaimer

All product specifications and data are subject to change without notice.

Vishay Intertechnology, Inc., its affiliates, agents, and employees, and all persons acting on its or their behalf (collectively, "Vishay"), disclaim any and all liability for any errors, inaccuracies or incompleteness contained herein or in any other disclosure relating to any product.

Vishay disclaims any and all liability arising out of the use or application of any product described herein or of any information provided herein to the maximum extent permitted by law. The product specifications do not expand or otherwise modify Vishay's terms and conditions of purchase, including but not limited to the warranty expressed therein, which apply to these products.

No license, express or implied, by estoppel or otherwise, to any intellectual property rights is granted by this document or by any conduct of Vishay.

The products shown herein are not designed for use in medical, life-saving, or life-sustaining applications unless otherwise expressly indicated. Customers using or selling Vishay products not expressly indicated for use in such applications do so entirely at their own risk and agree to fully indemnify Vishay for any damages arising or resulting from such use or sale. Please contact authorized Vishay personnel to obtain written terms and conditions regarding products designed for such applications.

Product names and markings noted herein may be trademarks of their respective owners.