

LM2825 Integrated Power Supply 1A DC-DC Converter

General Description

The LM2825 is a complete 1A DC-DC Buck converter packaged in a 24-lead molded Dual-In-Line integrated circuit package.

Contained within the package are all the active and passive components for a high efficiency step-down (buck) switching regulator. Available in fixed output voltages of 3.3V, 5V and 12V, as well as two adjustable versions, these devices can provide up to 1A of load current with fully guaranteed electrical specifications.

Self-contained, this converter is also fully protected from output fault conditions, such as excessive load current, short circuits, or excessive temperatures.

Highlights

- No external components required (fixed output voltage versions)
- Integrated circuit reliability
- MTBF over 20 million hours
- Radiated EMI meets Class B stipulated by CISPR 22
- High power density, 35 W/in³
- 24-pin DIP package profile (1.25 x 0.54 x 0.26 inches)

Features

- Minimum design time required
- 3.3V, 5V and 12V fixed output versions
- Two adjustable versions allow 1.23V to 15V outputs
- Wide input voltage range, up to 40V
- Low-power standby mode, I_Q typically 65 μ A
- High efficiency, typically 80%
- \pm 4% output voltage tolerance
- Excellent line and load regulation
- TTL shutdown capability/programmable Soft-start
- Thermal shutdown and current limit protection
- -40°C to +85°C ambient temperature range

Applications

- Simple high-efficiency step-down (buck) regulator
- On-card switching regulators
- Efficient pre-regulator for linear regulators
- Distributed power systems
- DC/DC module replacement

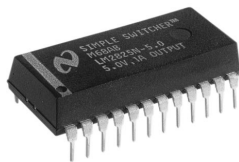

DS012661-27

Standard Application

(Fixed output voltage versions)

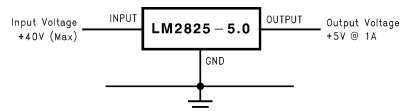

DS012661-1

Connection Diagram

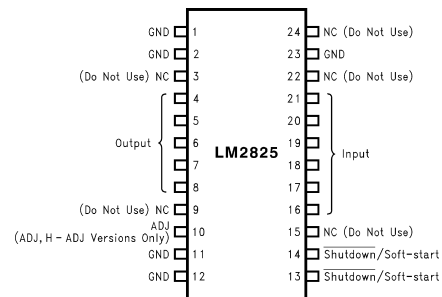

DS012661-2

"NC (Do not use)" pins: See Figure 11.

Top View

Ordering Information

Order Number **LM2825N-3.3**, **LM2825N-5.0**, **LM2825N-12**,
LM2825N-ADJ or **LM2825HN-ADJ**
See NS Package Number **NA24F**

Radiated EMI

Radiated emission of electromagnetic fields is measured at 10m distance. The emission levels are within the Class B limits stipulated by CISPR 22.

| | |
|--------------------|-----------------|
| 30. . . .230 MHz | 30 dB μ V/m |
| 230. . . .1000 MHz | 37 dB μ V/m |
| 1. . . .10 GHz | 46 dB μ V/m |

Absolute Maximum Ratings (Note 1)

If Military/Aerospace specified devices are required, please contact the National Semiconductor Sales Office/Distributors for availability and specifications.

| | |
|--|-----------------------------------|
| Maximum Input Supply (V_{IN}) | +45V |
| SD/SS Pin Input Voltage (Note 2) | 6V |
| Output Pin Voltage (3.3V, 5.0V and ADJ) | $-1V \leq V \leq 9V$ |
| (12V and H-ADJ) | $-1V \leq V \leq 16V$ |
| ADJ Pin Voltage (ADJ, H-ADJ only) | $-0.3V \leq V \leq 25V$ |
| Power Dissipation | Internally Limited |
| Storage Temperature Range | $-40^{\circ}C$ to $+125^{\circ}C$ |

ESD Susceptibility

| | |
|--------------------------------------|-------|
| Human Body Model (Note 3) | 2 kV |
| Lead Temperature (Soldering 10 sec.) | 260°C |

Operating Ratings

| | |
|-------------------------------------|--|
| Ambient Temperature Range | $-40^{\circ}C \leq T_A \leq +85^{\circ}C$ |
| Junction Temperature Range | $-40^{\circ}C \leq T_J \leq +125^{\circ}C$ |
| Input Supply Voltage (3.3V version) | 4.75V to 40V |
| Input Supply Voltage (5V version) | 7V to 40V |
| Input Supply Voltage (12V version) | 15V to 40V |
| Input Supply Voltage (-ADJ, H-ADJ) | 4.5V to 40V |

LM2825-3.3 Electrical Characteristics (Note 4)

Specifications with standard type face are for $T_A = 25^{\circ}C$, and those with **boldface type** apply over full Operating Temperature Range. Test Circuit Figure 2.

| Symbol | Parameter | Conditions | LM2825-3.3 | | Units (Limits) |
|-----------|-----------------------|--|------------------|--|-----------------------|
| | | | Typical (Note 6) | Limit (Note 7) | |
| V_{OUT} | Output Voltage | $4.75V \leq V_{IN} \leq 40V, 0.1A \leq I_{LOAD} \leq 1A$ | 3.3 | 3.168/ 3.135 3.432/ 3.465 | V V(min) V(max) |
| | Line Regulation | $4.75V \leq V_{IN} \leq 40V$ $I_{LOAD} = 100\text{ mA}$ | 1.5 | | mV |
| | Load Regulation | $0.1A \leq I_{LOAD} \leq 1A$ $V_{IN} = 12V$ | 8 | | mV |
| | Output Ripple Voltage | $V_{IN} = 12V, I_{LOAD} = 1A$ | 40 | | mV p-p |
| η | Efficiency | $V_{IN} = 12V, I_{LOAD} = 0.5A$ | 75 | | % |

LM2825-5.0 Electrical Characteristics (Note 4)

Specifications with standard type face are for $T_A = 25^{\circ}C$, and those with **boldface type** apply over full Operating Temperature Range. Test Circuit Figure 2.

| Symbol | Parameter | Conditions | LM2825-5.0 | | Units (Limits) |
|-----------|-----------------------|---|------------------|--|-----------------------|
| | | | Typical (Note 6) | Limit (Note 7) | |
| V_{OUT} | Output Voltage | $7V \leq V_{IN} \leq 40V, 0.1A \leq I_{LOAD} \leq 1A$ | 5.0 | 4.800/ 4.750 5.200/ 5.250 | V V(min) V(max) |
| | Line Regulation | $7V \leq V_{IN} \leq 40V$ $I_{LOAD} = 100\text{ mA}$ | 2.7 | | mV |
| | Load Regulation | $0.1A \leq I_{LOAD} \leq 1A$ $V_{IN} = 12V$ | 8 | | mV |
| | Output Ripple Voltage | $V_{IN} = 12V, I_{LOAD} = 1A$ | 40 | | mV p-p |
| η | Efficiency | $V_{IN} = 12V, I_{LOAD} = 0.5A$ | 80 | | % |

LM2825-12 Electrical Characteristics (Note 4)

Specifications with standard type face are for $T_A = 25^\circ\text{C}$, and those with **boldface type** apply over **full Operating Temperature Range**. Test Circuit *Figure 2*.

| Symbol | Parameter | Conditions | LM2825-12 | | Units (Limits) |
|-----------|-----------------------|--|------------------|--|-----------------------|
| | | | Typical (Note 6) | Limit (Note 7) | |
| V_{OUT} | Output Voltage | $15V \leq V_{IN} \leq 40V$, $0.1A \leq I_{LOAD} \leq 0.75A$ | 12.0 | 11.52/ 11.40 12.48/ 12.60 | V V(min) V(max) |
| | Line Regulation | $15V \leq V_{IN} \leq 40V$ $I_{LOAD} = 100\text{ mA}$ | 8.5 | | mV |
| | Load Regulation | $0.1A \leq I_{LOAD} \leq 0.75A$ $V_{IN} = 24V$ | 12 | | mV |
| | Output Ripple Voltage | $V_{IN} = 24V$, $I_{LOAD} = 1A$ | 100 | | mV p-p |
| η | Efficiency | $V_{IN} = 24V$, $I_{LOAD} = 0.5A$ | 87 | | % |

LM2825-ADJ Electrical Characteristics (Note 5)

Specifications with standard type face are for $T_A = 25^\circ\text{C}$, and those with **boldface type** apply over **full Operating Temperature Range**. Test Circuit *Figure 3*.

| Symbol | Parameter | Conditions | LM2825-ADJ | | Units (Limits) |
|-----------|--------------------|---|------------------|--|-----------------------|
| | | | Typical (Note 6) | Limit (Note 7) | |
| V_{ADJ} | Adjust Pin Voltage | $4.5V \leq V_{IN} \leq 40V$, $0.1A \leq I_{LOAD} \leq 1A$ $1.23V \leq V_{OUT} \leq 8V$ | 1.230 | 1.193/ 1.180 1.267/ 1.280 | V V(min) V(max) |
| η | Efficiency | $V_{IN} = 12V$, $I_{LOAD} = 0.5A$ V_{OUT} Programmed for 3V. See Circuit of <i>Figure 3</i> | 74 | | % |

LM2825H-ADJ Electrical Characteristics (Note 5)

Specifications with standard type face are for $T_A = 25^\circ\text{C}$, and those with **boldface type** apply over **full Operating Temperature Range**. Test Circuit *Figure 3*.

| Symbol | Parameter | Conditions | LM2825H-ADJ | | Units (Limits) |
|-----------|--------------------|---|------------------|--|-----------------------|
| | | | Typical (Note 6) | Limit (Note 7) | |
| V_{ADJ} | Adjust Pin Voltage | $9V \leq V_{IN} \leq 40V$, $0.1A \leq I_{LOAD} \leq 0.55A$ $7V \leq V_{OUT} \leq 15V$ | 1.230 | 1.193/ 1.180 1.267/ 1.280 | V V(min) V(max) |
| η | Efficiency | $V_{IN} = 24V$, $I_{LOAD} = 0.5A$ V_{OUT} Programmed for 12V. See Circuit of <i>Figure 3</i> | 87 | | % |

All Output Voltage Versions Electrical Characteristics

Specifications with standard type face are for $T_A = 25^\circ\text{C}$, and those with **boldface type** apply over **full Operating Range**. Unless otherwise specified, $V_{IN} = 12\text{V}$ for 3.3V, 5.0V and ADJ versions, $V_{IN} = 24\text{V}$ for 12V and H-ADJ versions, $I_{LOAD} = 100\text{ mA}$.

| Symbol | Parameter | Conditions | LM2825-XX | | Units (Limits) |
|---|-----------------------------|---|---------------------|-------------------|-------------------------------------|
| | | | Typical (Note 6) | Limit (Note 7) | |
| I_{CL} | DC Output Current Limit | $R_L = 0\Omega$ | 1.4 | | A A(min) A(max) |
| I_Q | Operating Quiescent Current | SD/SS Pin = 3.1V (Note 8) | 5 | 10 | mA mA(max) |
| I_{STBY} | Standby Quiescent Current | SD/SS Pin = 0V (Note 8) | 65 | 200 | μA $\mu\text{A(max)}$ |
| I_{ADJ} | Adjust Pin Bias Current | Adjustable Versions Only, $V_{FB} = 1.3\text{V}$ | 6 | 50/100 | nA nA(max) |
| f_O | Oscillator Frequency | (Note 9) | 150 | | kHz |
| θ_{JA} | Thermal Resistance | Junction to Ambient (Note 10) | 30 | | $^\circ\text{C/W}$ |
| SHUTDOWN/SOFT-START CONTROL Test Circuit <i>Figure 2</i> | | | | | |
| V_{SD} | Shutdown Threshold Voltage | Low (Shutdown Mode) High (Soft-start Mode) | 1.3 | 0.6 2.0 | V V(max) V(min) |
| V_{SS} | Soft-start Voltage | $V_{OUT} = 20\%$ of Nominal Output Voltage $V_{OUT} = 100\%$ of Nominal Output Voltage | 2 3 | | V |
| I_{SD} | Shutdown Current | $V_{SHUTDOWN} = 0.5\text{V}$ (Note 8) | 5 | 10 | μA $\mu\text{A(max)}$ |
| I_{SS} | Soft-start Current | $V_{SOFT-START} = 2.5\text{V}$ (Note 8) | 1.6 | 5 | μA $\mu\text{A(max)}$ |

Note 1: Absolute Maximum Ratings indicate limits beyond which damage to the device may occur. Operating Ratings indicate conditions for which the device is intended to be functional, but do not guarantee specific performance limits. For guaranteed specifications and test conditions, see the Electrical Characteristics.

Note 2: Voltage internally clamped. If clamp voltage is exceeded, limit current to a maximum of 5 mA.

Note 3: The human body model is a 100 pF capacitor discharged through a 1.5k resistor into each pin.

Note 4: When the LM2825 is used as shown in *Figure 2* test circuit, system performance will be as shown in Electrical Characteristics.

Note 5: When the LM2825 is used as shown in *Figure 3* test circuit, system performance will be as shown in Electrical Characteristics.

Note 6: Typical numbers are at 25°C and represent the most likely norm.

Note 7: All limits guaranteed at room temperature (standard type face) and at temperature extremes (bold type face) when output current is limited to the value given in the temperature derating curves. See the application section for curves. All limits at temperature extremes are guaranteed using standard Statistical Quality Control (SQC) methods. All limits are used to calculate Average Outgoing Quality Level (AOQL).

Note 8: $I_{LOAD} = 0\text{A}$.

Note 9: The switching frequency is reduced when the second stage current limit is activated. The amount of reduction is determined by the severity of current overload.

Note 10: Junction to ambient thermal resistance (no external heat sink) for the DIP-24 package with the leads soldered to a printed circuit board with (1 oz.) copper area of approximately 2 in^2 .

Typical Performance Characteristics (Circuits of Figure 2 and Figure 3) Unless otherwise specified, $V_{IN} = 12V$ for 3.3V, 5.0V and ADJ versions, $V_{IN} = 24V$ for 12V and H-ADJ versions, $I_{LOAD} = 100\text{ mA}$, $T_A = 25^\circ\text{C}$

Normalized Output Voltage

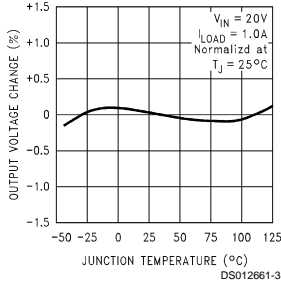

Efficiency

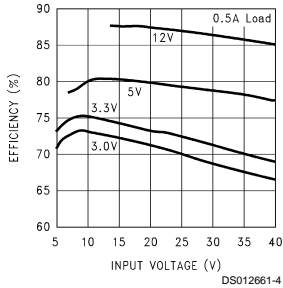

Dropout Voltage

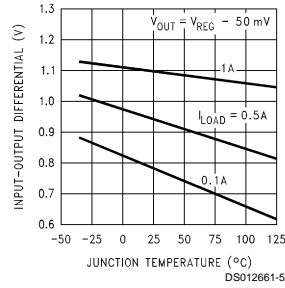

Line Regulation

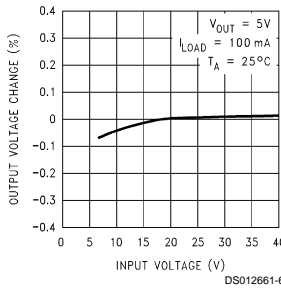

Load Regulation

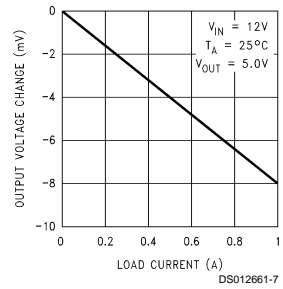

Output Ripple Voltage

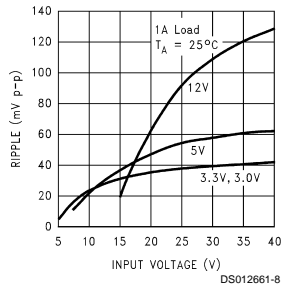

Operating Quiescent Current

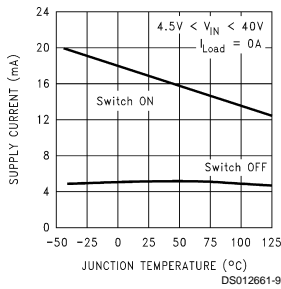

Shutdown Quiescent Current

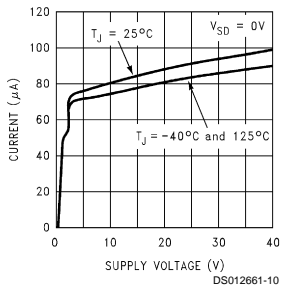

Switching Frequency

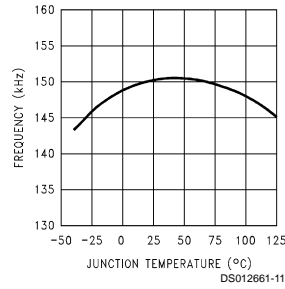

Typical Performance Characteristics (Circuits of Figure 2 and Figure 3) Unless otherwise specified, $V_{IN} = 12V$ for 3.3V, 5.0V and ADJ versions, $V_{IN} = 24V$ for 12V and H-ADJ versions, $I_{LOAD} = 100\text{ mA}$, $T_A = 25^\circ\text{C}$ (Continued)

Soft-start

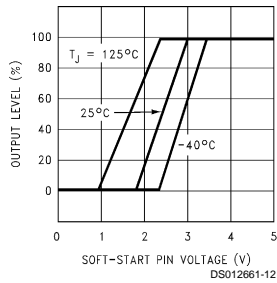

Shutdown /Soft-start Current

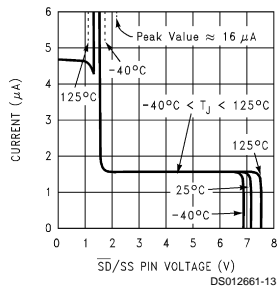

Soft-start Response

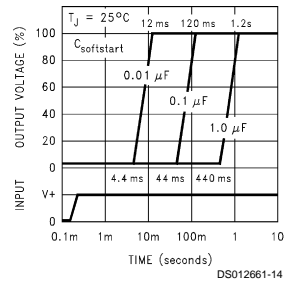

Switch Current Limit

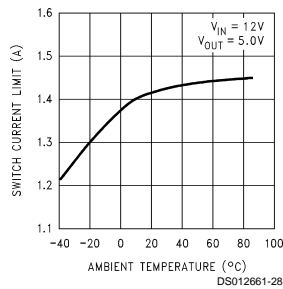

Adjust Pin Bias Current

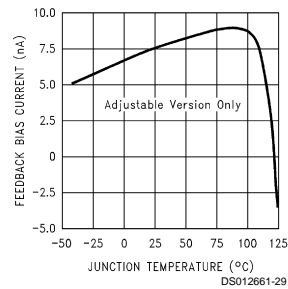

Load Transient Response for Continuous Mode
 $V_{IN} = 20V$, $V_{OUT} = 5V$, $I_L = 250\text{ mA}$ to 750 mA

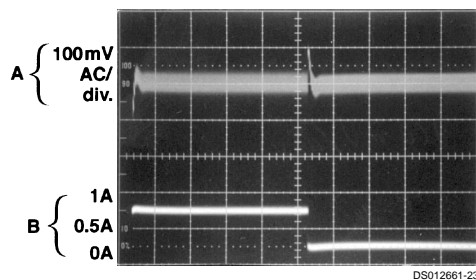

A: Output Voltage 100 mV/div (AC)
 B: 250 mA to 750 mA Load Pulse
 Horizontal Time Base: 200 $\mu\text{s}/\text{div}$

Load Transient Response for Discontinuous Mode
 $V_{IN} = 20V$, $V_{OUT} = 5V$, $I_L = 40\text{ mA}$ to 140 mA

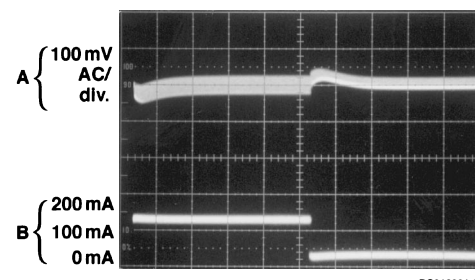

A: Output Voltage 100 mV/div (AC)
 B: 40 mA to 140 mA Load Pulse
 Horizontal Time Base: 200 $\mu\text{s}/\text{div}$

FIGURE 1. Typical Load Transient Response

Test Circuit

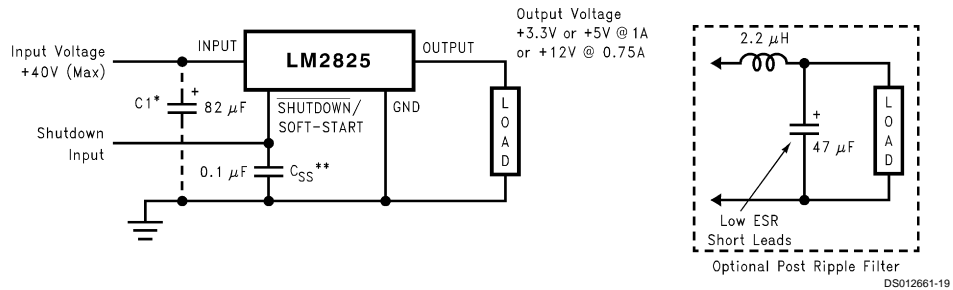

*Optional—Required if package is more than 6" away from main filter or bypass capacitor.

**Optional Soft-start Capacitor

$V_{IN} = 40V$ (max)

$V_{OUT} = 3.3V$ or $5V @ 1A$ or $12V @ 0.75A$

**FIGURE 2. Standard Test Circuit
(Fixed Output Voltage Versions)**

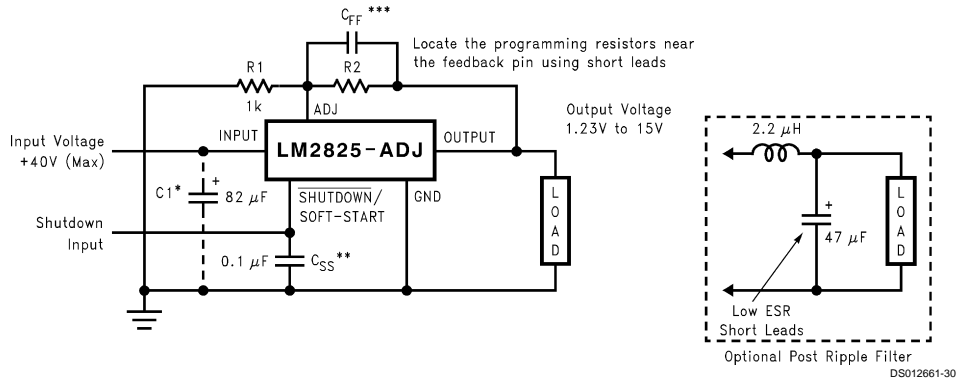

*Optional—Required if package is more than 6" away from main filter or bypass capacitor.

**Optional Soft-start Capacitor

***Optional—See Application Information.

$V_{IN} = 40V$ (max)

$V_{OUT} = 1.23V$ to $8V$ (LM2825-ADJ)

$7V$ to $15V$ (LM2825H-ADJ)

$I_{LOAD} = I_{MAX}$ (See derating curves)

**FIGURE 3. Standard Test Circuit
(Adjustable Output Voltage Versions)**

Application Information

PROGRAMMING OUTPUT VOLTAGE

(Selecting R_1 and R_2 as shown in Figure 3)

The LM2825 is available in two adjustable output versions. The LM2825-ADJ has been optimized for output voltages between 1.23V and 8V, while the LM2825H-ADJ covers the output voltage range of 7V to 15V. Both adjustable versions are set in the following way.

$$V_{OUT} = V_{REF} \left(1 + \frac{R_2}{R_1} \right) \text{ where } V_{REF} = 1.23V$$

Select a value for R_1 between 240Ω and $1.5 k\Omega$. The lower resistor values minimize noise pickup at the sensitive adjust pin. (For lowest temperature coefficient and the best stability with time, use 1% metal film resistors.)

Select R_2 with the following equation.

$$R_2 = R_1 \left(\frac{V_{OUT}}{V_{REF}} - 1 \right)$$

When programming V_{OUT} , keep in mind that V_{IN} must be greater than $V_{OUT} + 2V$ for proper operation.

OPTIONAL EXTERNAL COMPONENTS

SOFT-START CAPACITOR

C_{SS} : A capacitor on this pin provides the regulator with a Soft-start feature (slow start-up). The current drawn from the source starts out at a low average level with narrow pulses, and ramps up in a controlled manner as the pulses expand to their steady-state width. This reduces the startup current considerably, and delays and slows down the output voltage rise time.

Application Information (Continued)

It is especially useful in situations where the input power source is limited in the amount of current it can deliver, since you avoid loading down this type of power supply.

Under some operating conditions, a Soft-start capacitor is required for proper operation. *Figure 5* indicates the input voltage and ambient temperature conditions for which a Soft-start capacitor may be required.

This curve is typical for full guaranteed output current and can be used as a guideline. As the output current decreases, the operating area requiring a Soft-start capacitor decreases. Capacitor values between 0.1 μF and 1 μF are recommended. Tantalum or ceramic capacitors are appropriate for this application.

INPUT CAPACITOR

C_{IN}: An optional input capacitor is required if the package is more than 6" away from the main filter or bypass capacitor. A low ESR aluminum or tantalum bypass capacitor is recommended between the input pin and ground to prevent large voltage transients from appearing at the input. In addition, to be conservative, the RMS current rating of the input capacitor should be selected to be at least $\frac{1}{2}$ the DC load current. With a 1A load, a capacitor with a RMS current rating of at least 500 mA is recommended.

The voltage rating should be approximately 1.25 times the maximum input voltage. With a nominal input voltage of 12V, an aluminum electrolytic capacitor (Panasonic HFQ series or Nichicon PL series or equivalent) with a voltage rating greater than 15V ($1.25 \times V_{IN}$) would be needed.

Solid tantalum input capacitors should only be used where the input source is impedance current limited. High dV/dt applied at the input can cause excessive charge current through low ESR tantalum capacitors. This high charge current can result in shorting within the capacitor. It is recommended that they be surge current tested by the manufacturer. The TPS series available from AVX, and the 593D series from Sprague are both surge current tested.

Use caution when using ceramic capacitors for input bypassing, because it may cause ringing at the V_{IN} pin.

LOWERING OUTPUT RIPPLE

When using the adjustable parts, one can achieve lower output ripple voltage by shorting a resistor internal to the LM2825. However, if this resistor is shorted, a feed forward capacitor must be used to keep the regulator stable. For this reason, this resistor must be left open on all of the fixed output voltage versions or instability will result. See the feed forward capacitor selection below. Shorting the internal resistor is accomplished by shorting pins 8 and 9 on the LM2825, and will typically reduce output ripple by 25 to 33%.

FEED FORWARD CAPACITOR SELECTION (C_{FF})

When using an adjustable part and pins 8 and 9 are shorted to reduce output ripple, a feed forward capacitor is required. This capacitor is typically between 680 pF and 2700 pF. The table of *Figure 4* shows the value for C_{FF} for a given output voltage and feedback resistor R_2 ($R_1 = 1 \text{ k}\Omega$).

| V _{OUT} | R ₂ | C _{FF} |
|--------------------|----------------|-----------------|
| LM2825-ADJ | | |
| 2 | 630 | N/A |
| 3 | 1.43k | N/A |
| 4 | 2.26k | 2700 pF |
| 5 | 3.09k | 2700 pF |
| 6 | 3.92k | 2200 pF |
| 7 | 4.75k | 1800 pF |
| 8 | 5.49k | 1500 pF |
| LM2825H-ADJ | | |
| 7 | 4.75k | 2700 pF |
| 8 | 5.49k | 2200 pF |
| 9 | 6.34k | 1800 pF |
| 10 | 7.15k | 1500 pF |
| 11 | 8.06k | 1000 pF |
| 12 | 8.87k | 820 pF |
| 13 | 9.53k | 680 pF |
| 14 | 10.5k | 680 pF |
| 15 | 11.3k | 680 pF |

FIGURE 4. C_{FF} Selection Table

SHUTDOWN

The circuit shown in *Figure 10* shows 2 circuits for the Shutdown/Soft-start feature using different logic signals for shutdown and using a 0.1 μF Soft-start capacitor.

THERMAL CONSIDERATIONS

The LM2825 is available in a 24-pin through hole DIP. The package is molded plastic with a copper lead frame. When the package is soldered to the PC board, the copper and the board are the heat sink for the LM2825.

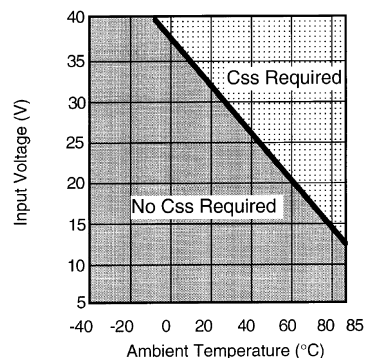

DS012661-22

FIGURE 5. Usage of the Soft-start Capacitor

Application Information (Continued)

OUTPUT CURRENT DERATING FOR $T_J = -40^\circ\text{C}$ to -25°C AND $T_J = -25^\circ\text{C}$ to 0°C

At the lower temperature extremes, the switch current limit drops off sharply. As a result, a lower output current is available in this temperature range. See Figure 6 and Figure 7 for the typical available output current at these temperature ranges.

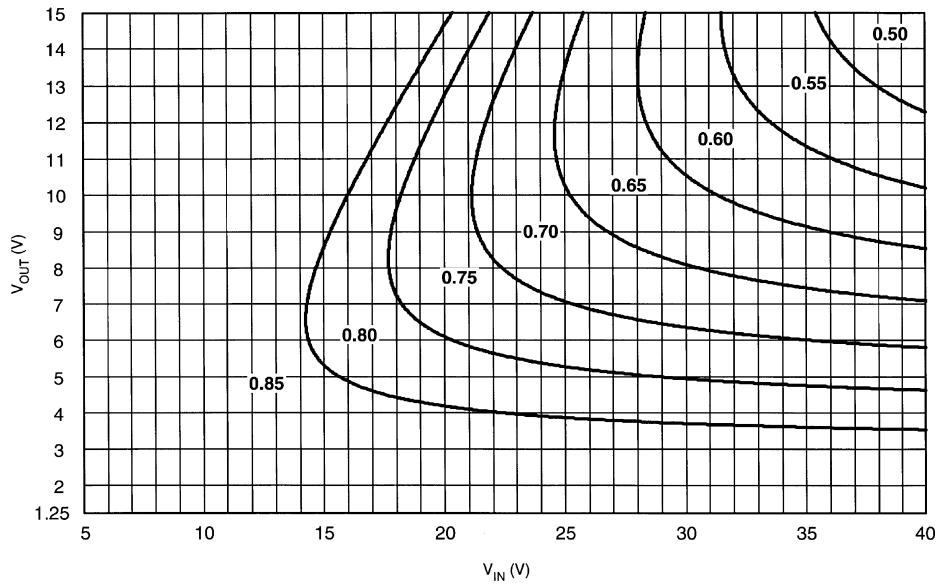

FIGURE 6. LM2825 Output Current Derating for $T_J = -40^\circ\text{C}$ to -25°C

DS012661-32

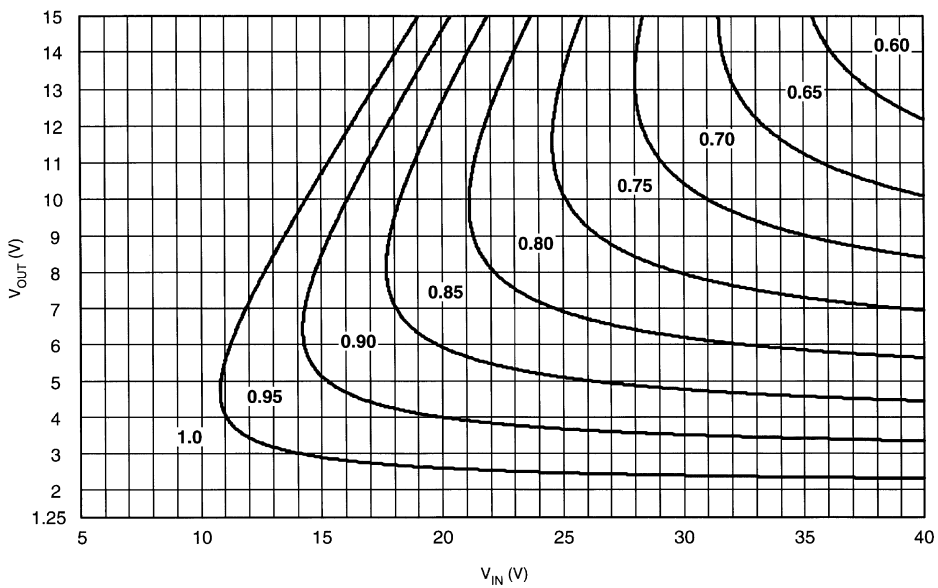

FIGURE 7. LM2825 Output Current Derating for $T_J = -25^\circ\text{C}$ to 0°C

DS012661-33

Application Information (Continued)

OUTPUT CURRENT DERATING FOR $T_A = 0^\circ\text{C}$ to 70°C

Due to the limited switch current, the LM2825 cannot supply the full one ampere output current over the entire input and output voltage range. *Figure 8* shows the typical available output current for any input and output voltage combination. This applies for all output voltage versions.

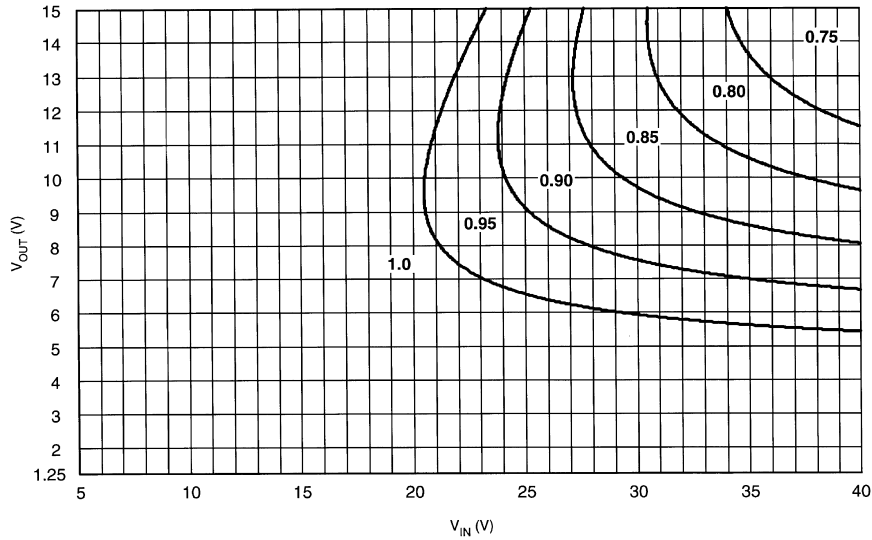

FIGURE 8. LM2825 Output Current Derating for $T_A = 0^\circ\text{C}$ to 70°C

DS012661-34

OUTPUT CURRENT DERATING FOR $T_A = 70^\circ\text{C}$ to 85°C

At high these high ambient temperatures, the LM2825 cannot supply the full one ampere over the entire input and output voltage range. This is due to thermal reasons and *Figure 9* shows the typical available output current for any input and output voltage combination. This applies for all output voltage versions.

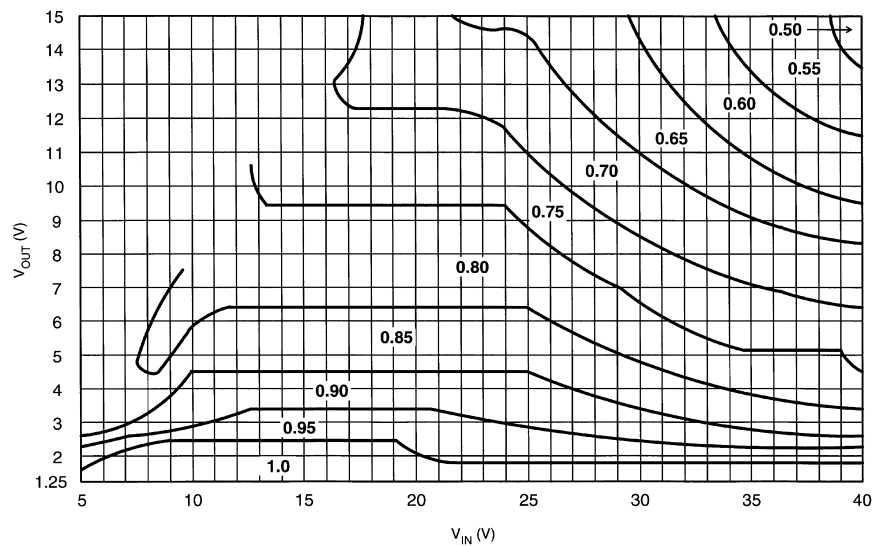
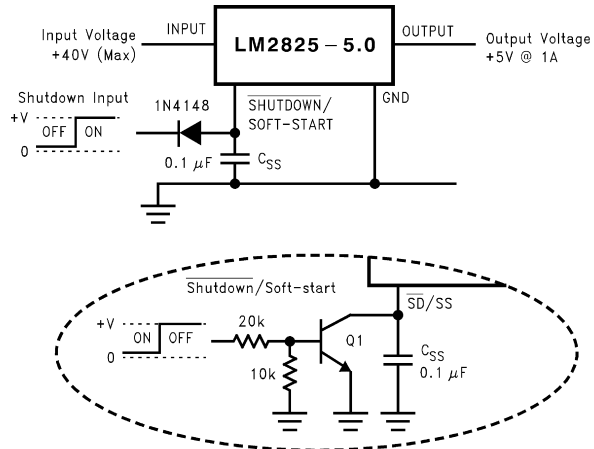

FIGURE 9. LM2825 Output Current Derating for $T_A = 70^\circ\text{C}$ to 85°C

DS012661-35

Application Information (Continued)



DS012661-25

FIGURE 10. Typical Circuits Using Shutdown /Soft-start Features

TYPICAL THROUGH HOLE PC BOARD LAYOUT (2X SIZE), SINGLE SIDED, THROUGH HOLE PLATED

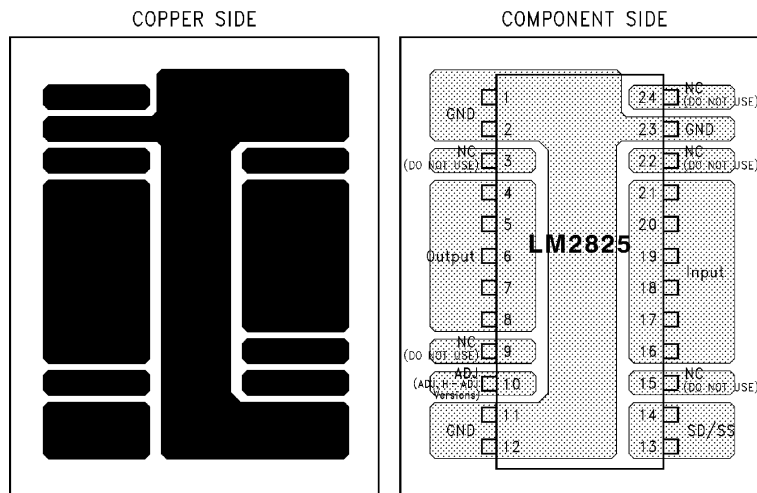

DS012661-26

Note: Holes are not shown.
 "No Connect Pins" are connected to copper pads for thermal reasons only and must remain electrically isolated.

FIGURE 11. 2X Printed Circuit Board Layout

Physical Dimensions inches (millimeters) unless otherwise noted

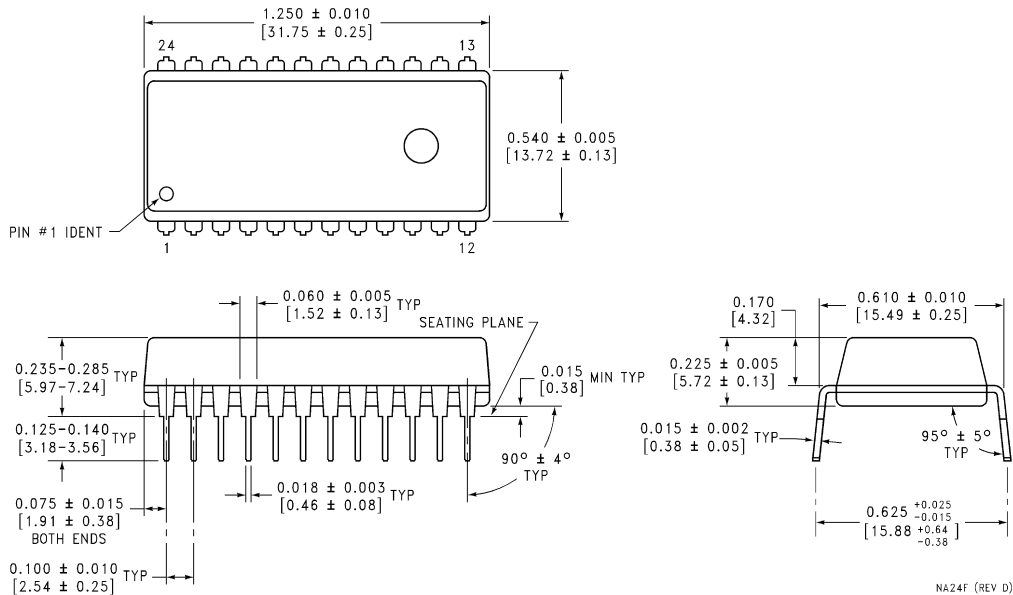

24-Lead (0.600" Wide) Molded Dual-In-Line Package
Order Number LM2825N-3.3, LM2825N-5.0, LM2825N12, LM2825N-ADJ or LM2825HN-ADJ
NS Package Number NA24F

LIFE SUPPORT POLICY

NATIONAL'S PRODUCTS ARE NOT AUTHORIZED FOR USE AS CRITICAL COMPONENTS IN LIFE SUPPORT DEVICES OR SYSTEMS WITHOUT THE EXPRESS WRITTEN APPROVAL OF THE PRESIDENT OF NATIONAL SEMICONDUCTOR CORPORATION. As used herein:

1. Life support devices or systems are devices or systems which, (a) are intended for surgical implant into the body, or (b) support or sustain life, and whose failure to perform when properly used in accordance with instructions for use provided in the labeling, can be reasonably expected to result in a significant injury to the user.
2. A critical component in any component of a life support device or system whose failure to perform can be reasonably expected to cause the failure of the life support device or system, or to affect its safety or effectiveness.

| | | | | |
|---|---|--------------------------------------|--|--|
|  | National Semiconductor Corporation | National Semiconductor Europe | National Semiconductor Hong Kong Ltd. | National Semiconductor Japan Ltd. |
| | Americas | | 13th Floor, Straight Block, | Tel: 81-3-5620-6175 |
| | Tel: 1-800-272-9959 | Fax: +49 (0) 1 80-530 85 86 | Ocean Centre, 5 Canton Rd. | Fax: 81-3-5620-6179 |
| | Fax: 1-800-737-7018 | Email: europe.support@nsc.com | Tsimshatsui, Kowloon | |
| | Email: support@nsc.com | English Tel: +49 (0) 1 80-532 78 32 | Hong Kong | |
| | | Français Tel: +49 (0) 1 80-532 93 58 | Tel: (852) 2737-1600 | |
| | | Italiano Tel: +49 (0) 1 80-534 16 80 | Fax: (852) 2736-9960 | |
| www.national.com | | | | |

National does not assume any responsibility for use of any circuitry described, no circuit patent licenses are implied and National reserves the right at any time without notice to change said circuitry and specifications.