

# AS1323

Data Sheet

## 1.6µA Quiescent Current, Single Cell, DC-DC Step-up Converter

### 1 General Description

The AS1323 high-efficiency step-up DC-DC converter was designed specifically for single-cell, battery-powered devices where lowest quiescent current and high efficiency are essential.

The compact device is available in three fixed-voltage variations and is perfect for a wide variety of applications where extremely-low quiescent currents and very-small form factors are critical.

The devices are available as the standard products shown in [Table 1](#). See also [Ordering Information on page 13](#).

Table 1. Standard Products

Model	Fixed Output Voltage	Package
AS1323-27	2.7V	TSOT23-5
AS1323-30	3.0V	TSOT23-5
AS1323-33	3.3V	TSOT23-5

Integrated boot circuitry ensures start-up even with very-high load currents.

The true output disconnect feature completely disconnects the output from the battery during shutdown.

The device is available in a TSOT23-5 pin package.

### 2 Key Features

- 1.6µA Quiescent Current
- Input Voltage Range: 0.75 to 2V
- Up to 100mA Output Current
- Fixed Output Voltages: 2.7, 3.0 and 3.3V
- Shutdown Current: 0.1µA
- Output Voltage Accuracy: ±3%
- Efficiency: Up to 85%
- No External Diode or FETs Needed
- Output Disconnect in Shutdown
- Guaranteed 0.95V Start-Up Voltage
- TSOT23-5 Package

### 3 Applications

The devices are ideal for single-cell portable devices including mobile phones, MP3 players, PDAs, remote controls, personal medical devices, wireless transmitters and receivers, and any other battery-operated, portable device.

Figure 1. Typical Operating Circuit

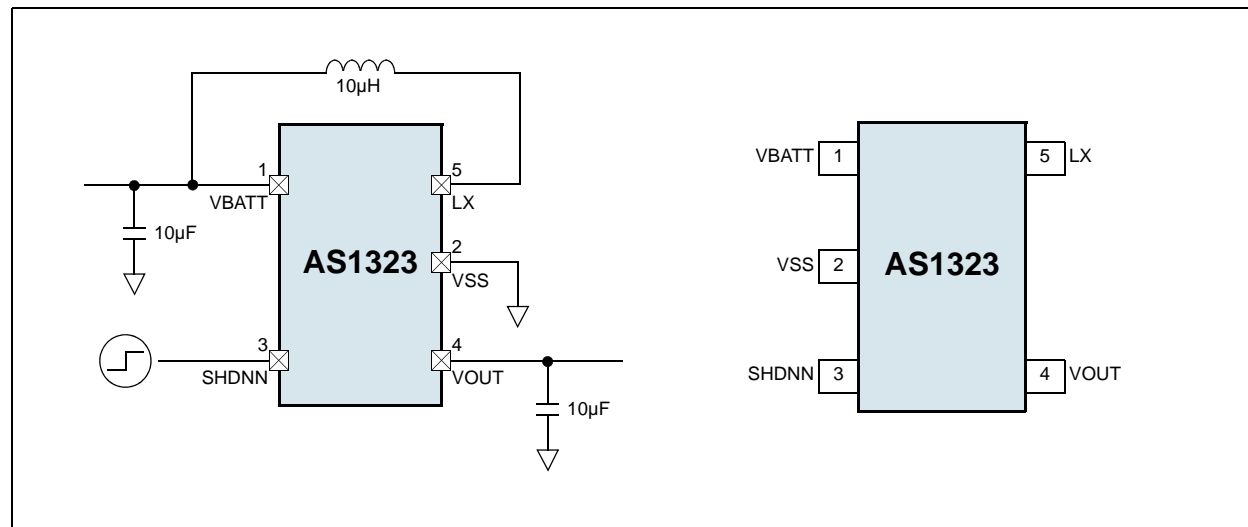

## 4 Pinout

### Pin Assignments

Figure 2. Pin Assignments (Top View)

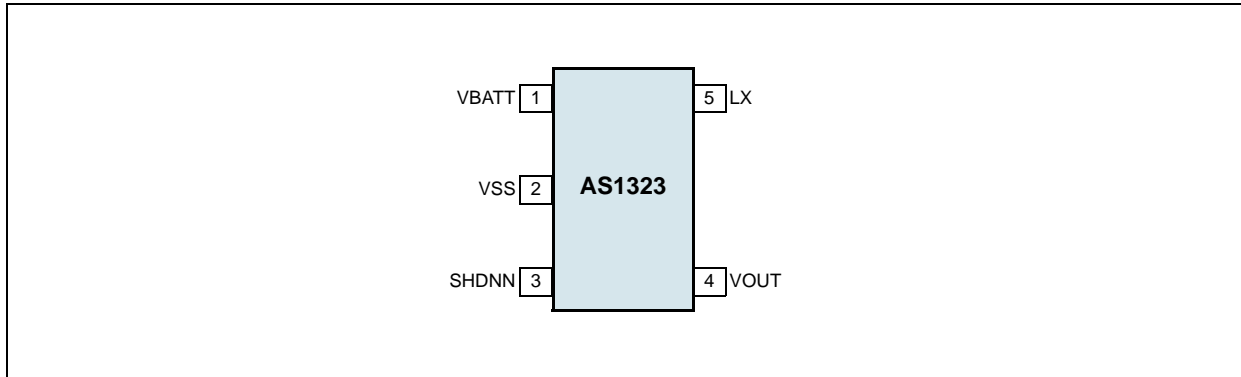

### Pin Descriptions

Table 2. Pin Descriptions

Pin Number	Pin Name	Description
1	VBATT	<b>Battery Supply Input and Coil Connection</b>
2	VSS	<b>Negative Supply and Ground</b>
3	SHDNN	<b>Shutdown Input.</b> 0 = Shutdown mode. 1 = Normal operating mode.
4	VOUT	<b>Output.</b> This pin also supplies bootstrap power to the device.
5	LX	<b>Inductor Connection.</b> This pin is connected to the internal N-channel MOSFET switch drain and P-channel synchronous rectifier drain.

## 5 Absolute Maximum Ratings

Stresses beyond those listed in [Table 3](#) may cause permanent damage to the device. These are stress ratings only, and functional operation of the device at these or any other conditions beyond those indicated in [Electrical Characteristics on page 4](#) is not implied. Exposure to absolute maximum rating conditions for extended periods may affect device reliability.

Table 3. Absolute Maximum Ratings

Parameter	Min	Max	Units	Comments
VBATT, SHDNN, LX to VSS	-0.3	+5	V	
Maximum Current VOUT, LX		1	A	
Thermal Resistance $\Theta_{JA}$		207.4	°C/W	on PCB
Electro-Static Discharge		2	kV	HBM
Operating Temperature Range	-40	+85	°C	
Storage Temperature Range	-65	+150	°C	
Junction Temperature		+150	°C	
Package Body Temperature		+260	°C	The reflow peak soldering temperature (body temperature) specified is in accordance with <i>IPC/JEDEC J-STD-020C "Moisture/Reflow Sensitivity Classification for Non-Hermetic Solid State Surface Mount Devices"</i> . The lead finish for Pb-free leaded packages is matte tin (100% Sn).

## 6 Electrical Characteristics

### DC Electrical Characteristics

$T_{AMB} = -40^{\circ}\text{C}$  to  $+85^{\circ}\text{C}$ ,  $V_{BATT} = 1.2\text{V}$ ,  $V_{OUT} = V_{OUT(NOM)}$ ,  $SHDNN = V_{OUT}$ ,  $R_{LOAD} = \infty$ , unless otherwise noted. Typical values are at  $T_A = 25^{\circ}\text{C}$ . (unless otherwise specified). Limits are 100% production tested at  $T_{AMB} = 25^{\circ}\text{C}$ . Limits over the operating temperature range are guaranteed by design.

Table 4. Electrical Characteristics

Symbol	Parameter	Condition	Min	Typ	Max	Unit
$V_{INMIN}$	Minimum Input Voltage			0.75		V
$V_{IN}$	Operating Input Voltage	$T_{AMB} = 25^{\circ}\text{C}$	0.95		2	V
$V_{INSU}$	Minimum Start-Up Input Voltage	$T_{AMB} = 25^{\circ}\text{C}$ , $R_{LOAD} = 100\Omega$		0.75	0.95	V
$V_{OUT}$	Output Voltage	AS1323-27	2.619	2.7	2.781	V
		AS1323-30	2.91	3.0	3.09	
		AS1323-33	3.201	3.3	3.399	
$R_{LOAD}$	Load depended drop of $V_{OUT}$	$V_{BATT} = 1.5\text{V}$ ; $I_{LOAD} = 45\text{mA}$		30	40	mV
$R_{DS-ON}$	N-Channel On-Resistance			0.5	1.0	$\Omega$
	P-Channel On-Resistance			0.75	1.5	$\Omega$
$I_{LIMIT}$	N-Channel Switch Current Limit	Programmed at 400mA		400		mA
$t_{ON}$	Switch Maximum On-Time			6		$\mu\text{s}$
	Synchronous Rectifier Zero-Crossing Current			10		mA
$I_{OP-OUT}$	Operating Current into $V_{BATT}$	$V_{BATT} = 1.5\text{V}$ , $V_{OUT} = 3.3\text{V}$ , $T_{AMB} = 25^{\circ}\text{C}$		6		$\mu\text{A}$
$I_{Q-OUT}$	Quiescent Current to $V_{OUT}$			1.6	3	$\mu\text{A}$
$I_{Q-BAT}$	Quiescent Current into $V_{BATT}$	$V_{BATT} = 1.5\text{V}$ , $T_{AMB} = 25^{\circ}\text{C}$		0.3	1	$\mu\text{A}$
$I_{SDI-OUT}^1$	Shutdown Current to $V_{OUT}$				200	nA
$I_{SDI-BAT}$	Shutdown Current into $V_{BATT}$	$V_{BATT} = 1.5\text{V}$ , $T_{AMB} = 25^{\circ}\text{C}$		100		nA
$V_{IL}$	SHDNN Voltage Threshold, Low		150			mV
$V_{IH}$	SHDNN Voltage Threshold, High				900	mV
$I_{SDI}$	SHDNN Input Bias Current	$T_{AMB} = 25^{\circ}\text{C}$ , $V_{SDI} = V_{OUT}$		100	300	nA

1.  $V_{OUT}$  is completely disconnected (0V) during shutdown.

## 7 Typical Operating Characteristics

$V_{OUT} = 3.3V$ ;  $T_A = 25^\circ C$ ;  $C_{IN} = C_{OUT} = 10\mu F$ ,  $L = 10\mu H$ ,  $I_{LOAD} = 10mA$ ;  $V_{BATT} = 1.5V$ ; unless otherwise specified.

Figure 3. Efficiency vs. Output Current;  $V_{OUT} = 3.3V$

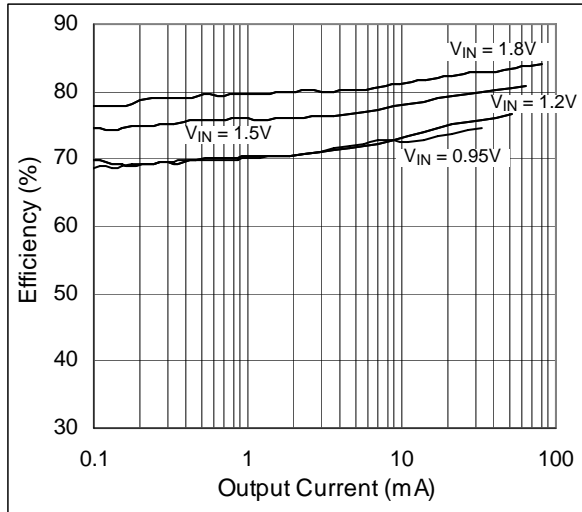

Figure 4. Efficiency vs. Output Current;  $V_{OUT} = 3.0V$

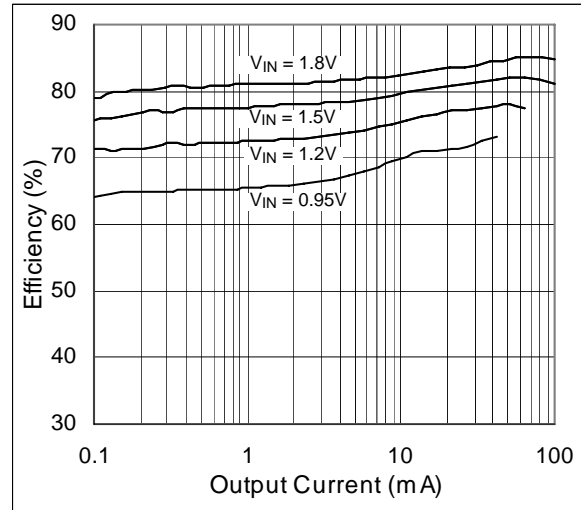

Figure 5. Efficiency vs. Output Current;  $V_{OUT} = 2.7V$

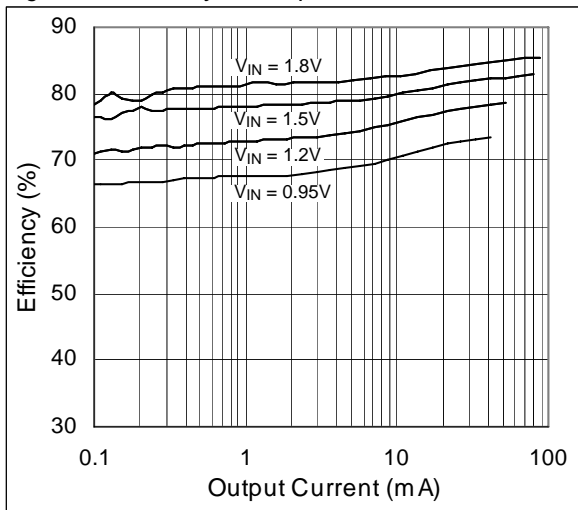

Figure 6. Efficiency vs. Input Voltage

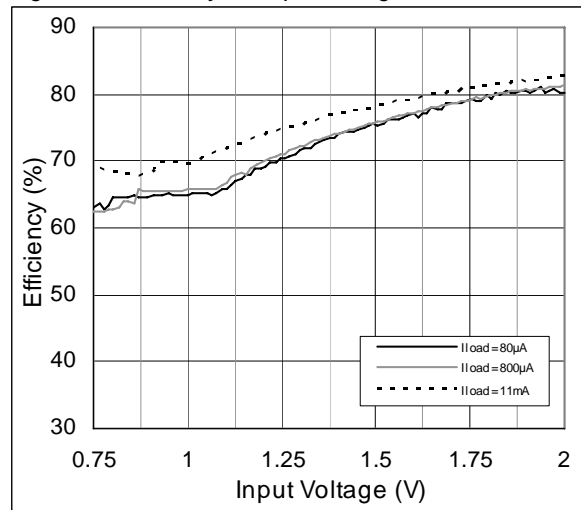

Figure 7. Output Voltage vs. Temperature

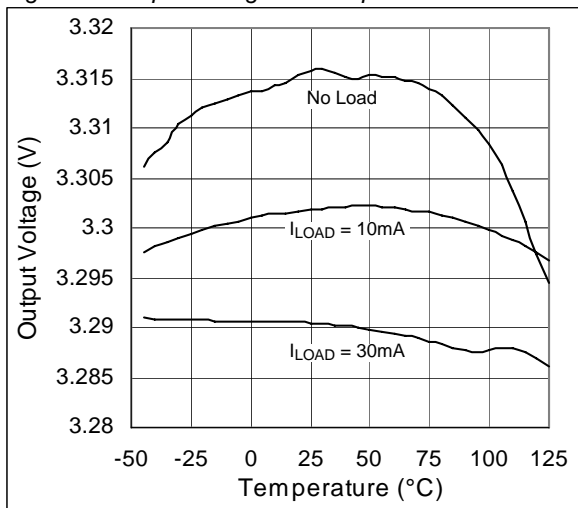

Figure 8. Output Voltage vs. Output Current

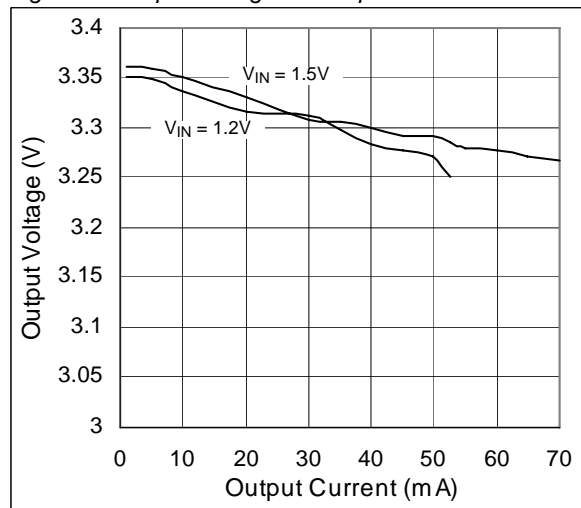

Figure 9. Output Voltage vs. Input Voltage

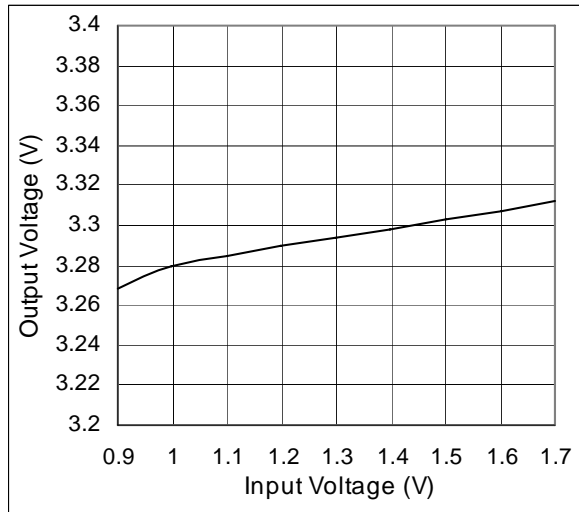

Figure 10. Shutdown Current vs. Temperature

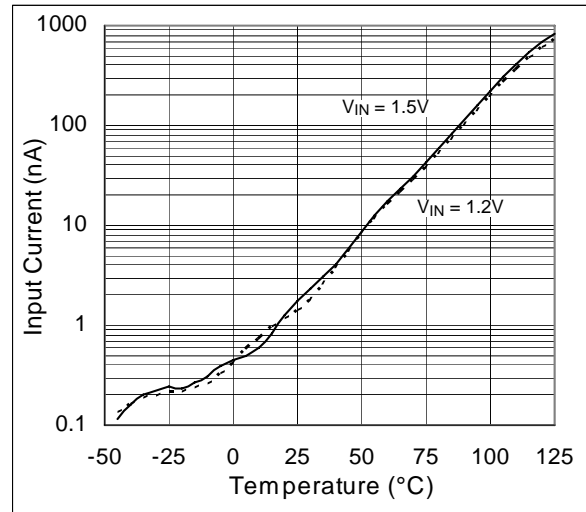

Figure 11. Minimum Input Startup Voltage vs. Temperature

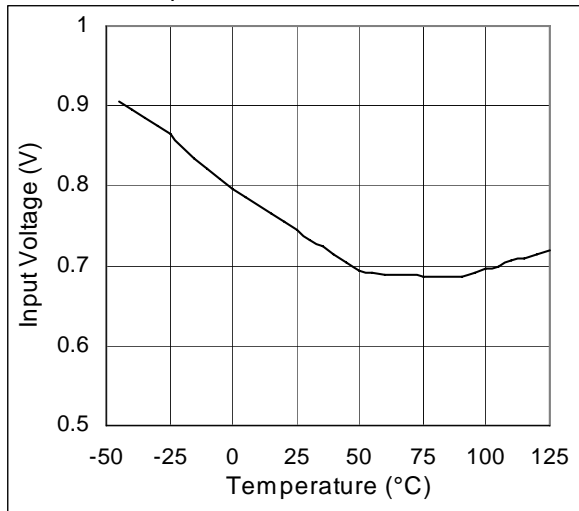

Figure 12. Output Voltage vs. Input Voltage; VOUT = 2.7V

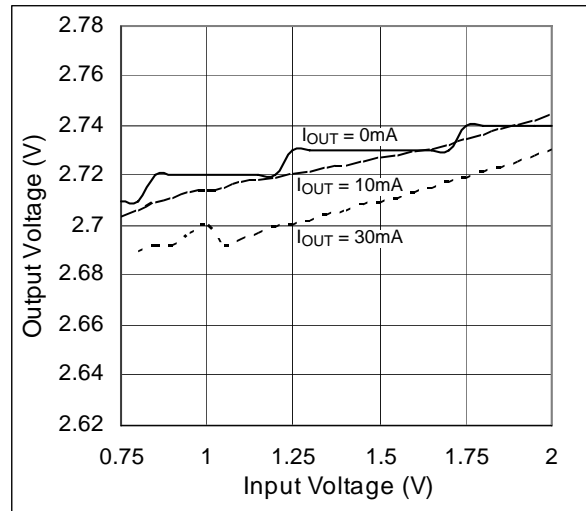

Figure 13. Output Voltage vs. Input Voltage; VOUT = 3.0V

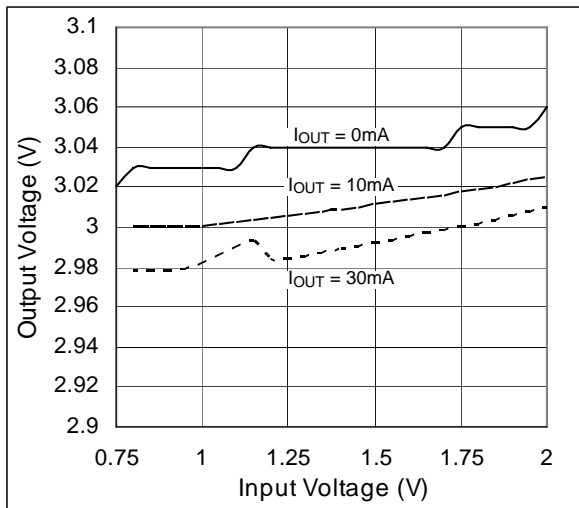

Figure 14. Output Voltage vs. Input Voltage; VOUT = 3.3V

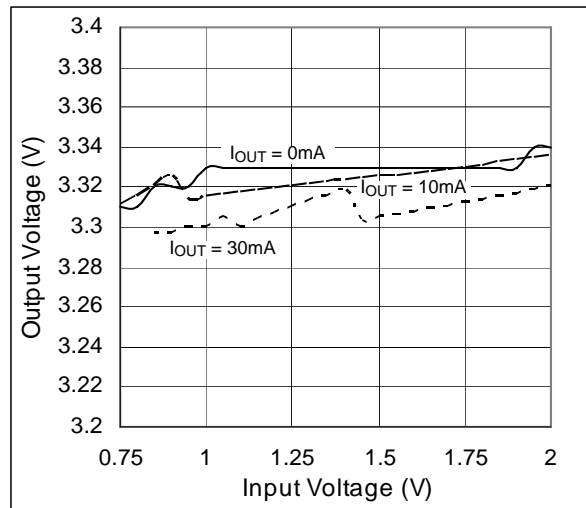

Figure 15. Output Current vs. Input Voltage

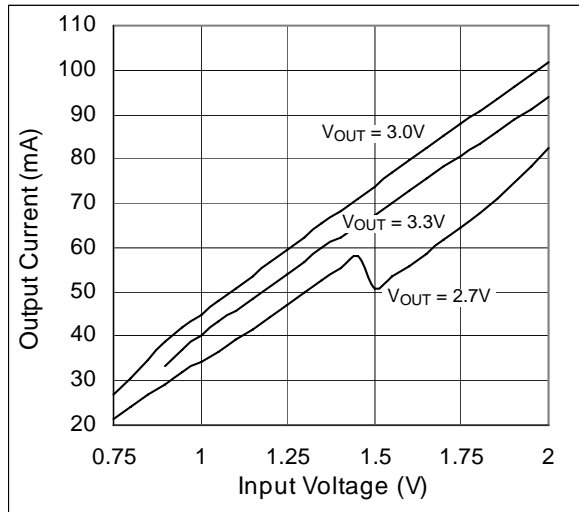

Figure 16. Switching Waveform;  $V_{OUT} = 2.7V$

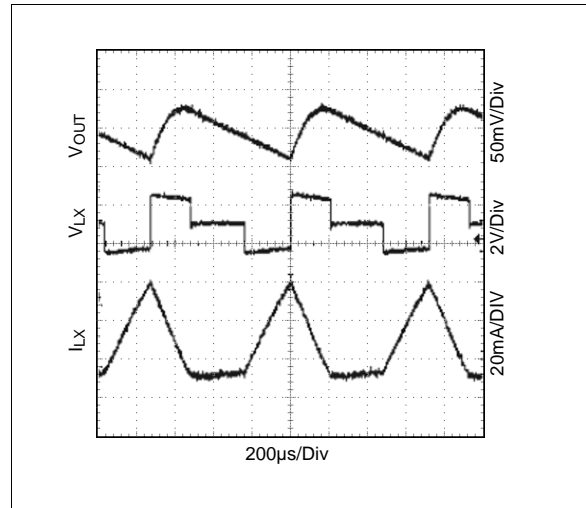

Figure 17. Switching Waveform;  $V_{OUT} = 3.0V$

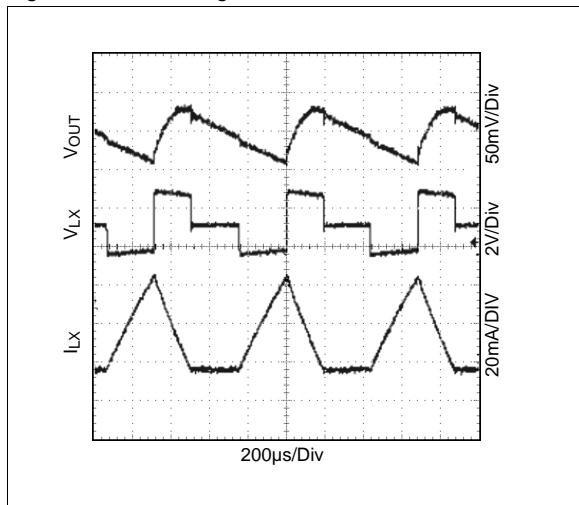
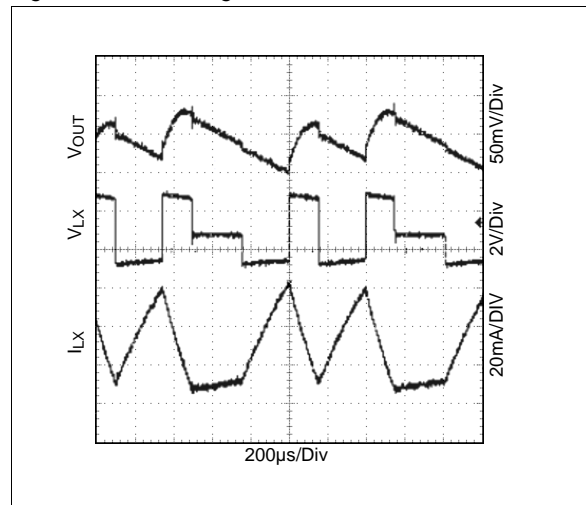

Figure 18. Switching Waveform;  $V_{OUT} = 3.3V$



## 8 Detailed Description

The AS1323 is a compact, high-efficiency, step-up DC-DC converter guaranteed to start up with voltages as low as 0.95V, and operate with an input voltage down to 0.75V. Consuming only 1.6 $\mu$ A of quiescent current, the device includes an integrated synchronous rectifier that eliminates the need for an external diode and improves overall efficiency by minimizing losses (see [Synchronous Rectification on page 8](#)). The AS1323 also features an active-low shutdown circuit that supply current to 0.1 $\mu$ A.

Figure 19. Block Diagram

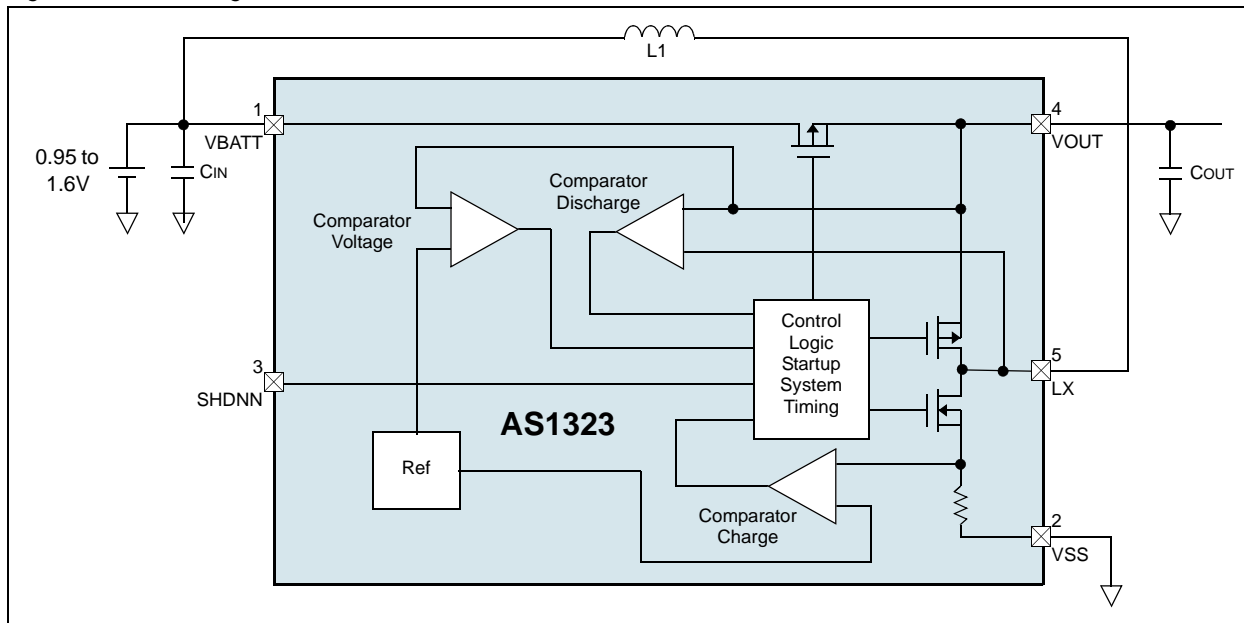

### PFM Control

A forced discontinuous, current-limited, pulse-frequency modulation (PFM) control scheme provides ultra-low quiescent current and high efficiency over a wide output current-range. Rather than using an integrated oscillator, the inductor current is limited by the 400mA N-channel current limit or by the 6 $\mu$ s switch maximum on-time. After each device-on cycle, the inductor current must ramp to zero before another cycle can start. When the error comparator senses that the output has fallen below the regulation threshold, another cycle can begin.

### Synchronous Rectification

The integrated synchronous rectifier eliminates the need for an external Schottky diode, reducing cost and PCB space. During normal operation, while the inductor discharges, the P-channel MOSFET turns on and shunts the MOSFET body diode. Consequently the rectifier voltage drop is significantly reduced improving efficiency without the need for external components.

### Low-Voltage Startup Circuit

The AS1323 contains a unique low-voltage startup circuit which ensures start-up even with very high load currents. The minimum start-up voltage is independent of the load current. This device is powered from pin VBATT, guaranteeing startup at input voltages as low as 0.95V.

### Shutdown

The AS1323 enter shutdown when the SHDNN pin is driven low. During shutdown, the output is completely disconnected from the battery. Shutdown can be pulled as high as 3.6V, regardless of the voltage at pins VBATT or VOUT. For normal operation, connect SHDN to the input.



## 9 Application Information

Figure 20. Typical Application

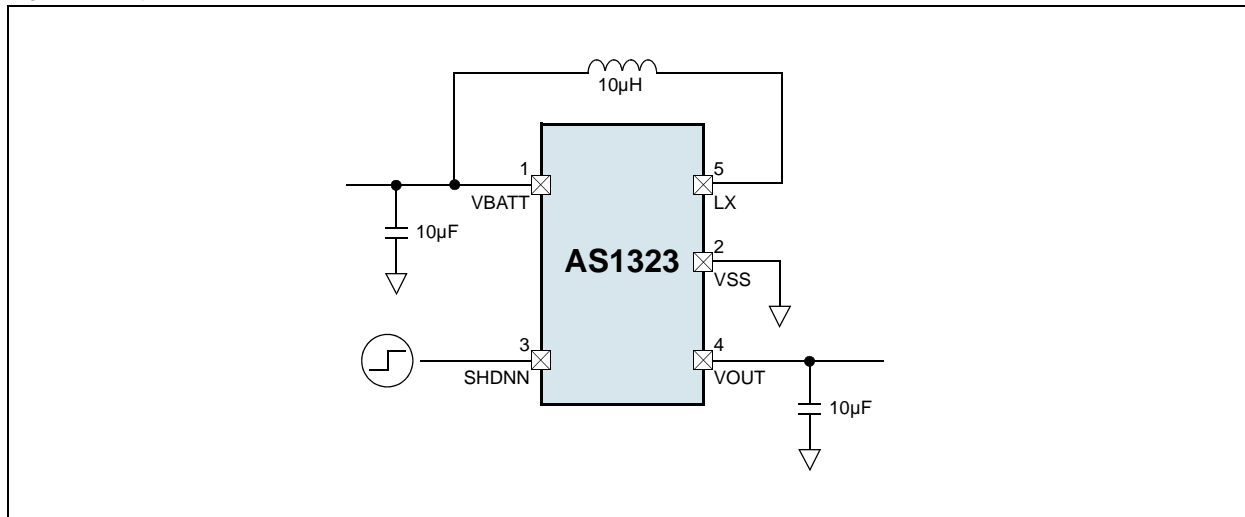

### Inductor Selection

The control scheme of the AS1323 allows for a wide range of inductor values. A 10µH inductor should be sufficient for most applications (see Figure 20).

Smaller inductance values typically offer smaller physical size for a given series resistance, allowing the smallest overall circuit dimensions. Applications using larger inductance values may startup at lower battery voltages, provide higher efficiency and exhibit less ripple, but they may reduce the maximum output current. This occurs when the inductance is sufficiently large to prevent the maximum current limit ( $I_{LIMIT}$ ) from being reached before the maximum on-time ( $t_{ON}$ ) expires (see Electrical Characteristics on page 4).

For maximum output current, the inductor value should be chosen such that the controller reaches the current-limit before the maximum on-time is triggered:

$$L > \frac{V_{BATT} \cdot t_{ON}}{I_{LIMIT}} \quad (EQ 1)$$

$t_{ONMAX}$  is 6µs (typ).

$I_{LIMIT}$  is 400mA (typ).

For larger inductor values, the peak inductor current ( $I_{PEAK}$ ) can be determined by:

The inductor's incremental saturation current rating should be greater than the peak switching current. However, it is

$$I_{PEAK} = \frac{V_{BATT} \cdot t_{ON}}{L} \quad (EQ 2)$$

generally advisable to bias the inductor into saturation by as much as 20%, although this will slightly reduce efficiency.

### Maximum Output Current

The maximum output current ( $I_{OUTMAX}$ ) is a function of  $I_{PEAK}$ ,  $V_{IN}$ ,  $V_{OUT}$ , and the overall efficiency ( $\eta$ ) as indicated in the formula for determining  $I_{OUTMAX}$ :

$$I_{OUTMAX} = \frac{1}{2} \cdot I_{PEAK} \cdot \left( \frac{V_{BATT}}{V_{OUT}} \right) \cdot \eta \quad (EQ 3)$$

## Capacitor Selection

Choose input and output capacitors to supply the input and output peak currents with acceptable voltage ripple. The input filter capacitor ( $C_{IN}$ ) reduces peak currents drawn from the battery and improves efficiency. Low equivalent series resistance (ESR) capacitors are recommended.

**Note:** Ceramic capacitors have the lowest ESR, but low ESR tantalum or polymer capacitors offer a good balance between cost and performance.

Output voltage ripple has two components: variations in the charge stored in the output capacitor with each COIL pulse, and the voltage drop across the capacitor's ESR caused by the current into and out of the capacitor:

$$V_{RIPPLE} = V_{RIPPLE(C)} + V_{RIPPLE(ESR)} \quad (EQ\ 4)$$

$$V_{RIPPLE(ESR)} = I_{PEAK} \cdot R_{ESR(COUT)} \quad (EQ\ 5)$$

$$V_{RIPPLE(C)} \approx \frac{1}{2} \cdot \left( \frac{L}{(V_{OUT} - V_{BATT}) \cdot C_{OUT}} \right) \cdot (I_{PEAK}^2 - I_{OUT}^2) \quad (EQ\ 6)$$

**Where:**  $I_{PEAK}$  is the peak inductor current.

For ceramic capacitors, the output voltage ripple is typically dominated by  $V_{RIPPLE(C)}$ . For example, a 10 $\mu$ F ceramic capacitor and a 10 $\mu$ H inductor typically provide 75mV of output ripple when stepping up from 1.2V to 3.3V at 50mA. Low input-to-output voltage differences require higher output capacitor values.

Capacitance and ESR variation of temperature should be considered for best performance in applications with wide operating temperature ranges.

## PC Board Layout Considerations

The AS1323 has been specially designed to be tolerant to PC board parasitic inductances and resistances. However, to achieve maximum efficiency a careful PC board layout and component selection is vital.

**Note:** For the optimal performance the IC's VSS and the ground leads of the input and output capacitors must be kept less than 5mm apart using a ground plane. In addition, keep all connections to COIL as short as possible.

The system robustness guarantees a reliable operation even if those recommendations are not fully applied.

## 10 Package Drawings and Markings

The device is available in an TSOT23-5 package.

Figure 21. TSOT23-5 Package

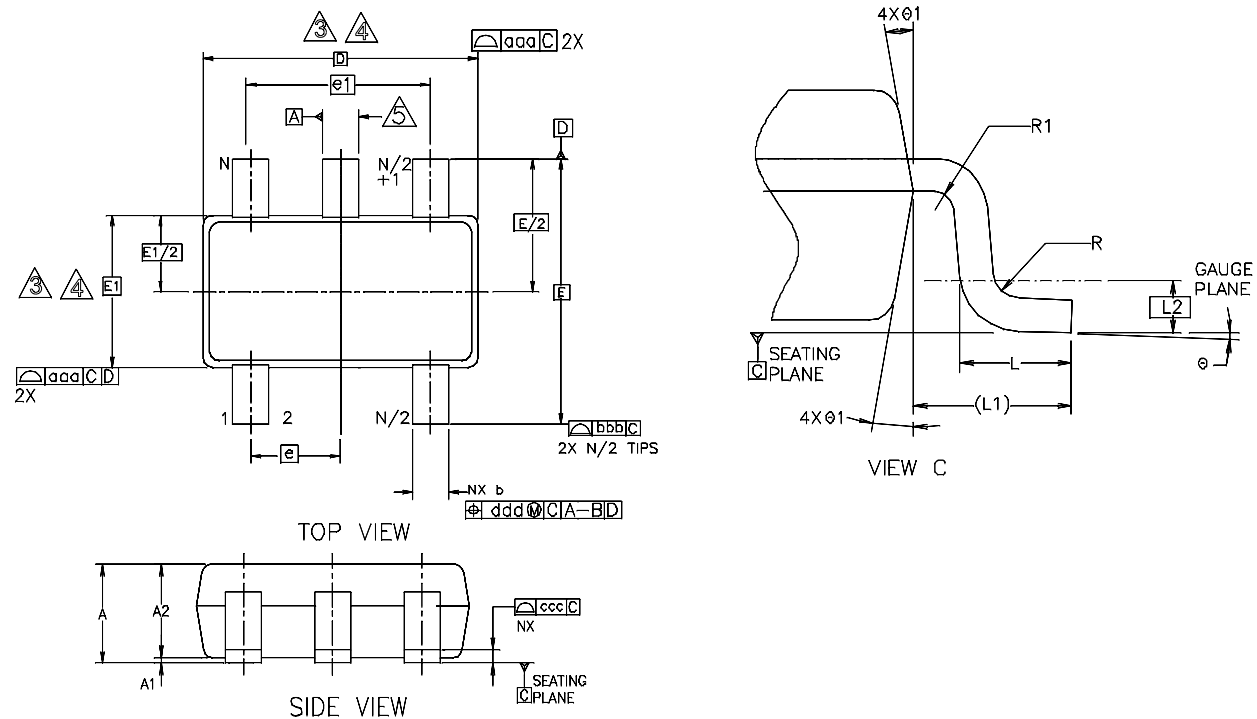

Symbol	Min	Typ	Max	Notes	Symbol	Min	Typ	Max	Notes
A			1.00		L	0.30	0.40	0.50	
A1	0.01	0.05	0.10		L1	0.60REF			
A2	0.84	0.87	0.90		L2	0.25BSC			
b	0.30		0.45		N		5		
b1	0.31	0.35	0.39		R	0.10			
c	0.12	0.15	0.20		R1	0.10		0.25	
c1	0.08	0.13	0.16		θ	0°	4°	8°	
D	2.90BSC			3,4	θ1	4°	10°	12°	
E	2.80BSC			3,4	<b>Tolerances of Form and Position</b>				
E1	1.60BSC			3,4	aaa		0.15		
e	0.95BSC				bbb		0.25		
e1	1.90BSC				ccc		0.10		
					ddd		0.20		

### Notes:

1. Dimensioning and tolerancing conform to *ASME Y14.5M - 1994*.
2. Dimensions are in millimeters.
3. Dimension D does not include mold flash, protrusions, or gate burrs. Mold flash, protrusions, and gate burrs shall not exceed 0.15mm per end. Dimension E1 does not include interlead flash or protrusion. Interlead flash or protrusion shall not exceed 0.15mm per side. Dimensions D and E1 are determined at datum H.
4. The package top can be smaller than the package bottom. Dimensions D and E1 are determined at the outermost extremes of the plastic body exclusive of mold flash, tie bar burrs, gate burrs, and interlead flash, but include any mismatches between the top of the package body and the bottom. D and E1 are determined at datum H.

## Tape and Reel Pin1 Orientation

Figure 22. Tape&Reel Pin1 Orientation

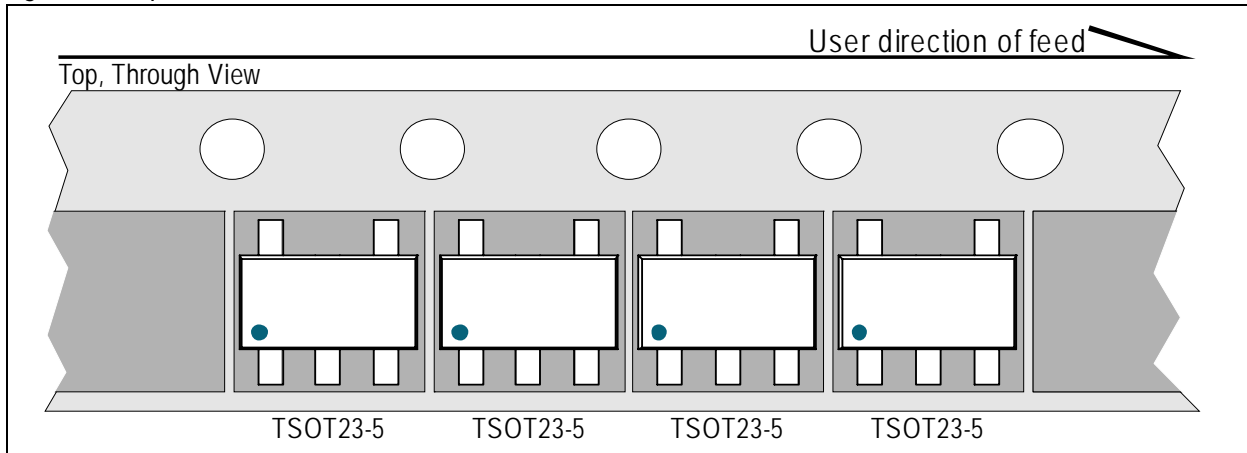

## 11 Ordering Information

The device is available as the standard products shown in [Table 5](#).

Table 5. Ordering Information

Model	Marking	Output	Description	Delivery Form	Package
AS1323-BTTT-27	ASJN	2.7V	1.6 $\mu$ A Quiescent Current, Single Cell, DC-DC Step-up Converter	Tape and Reel	TSOT23-5
AS1323-BTTT-30	ASMP	3.0V	1.6 $\mu$ A Quiescent Current, Single Cell, DC-DC Step-up Converter	Tape and Reel	TSOT23-5
AS1323-BTTT-33	ASMQ	3.3V	1.6 $\mu$ A Quiescent Current, Single Cell, DC-DC Step-up Converter	Tape and Reel	TSOT23-5

All devices are RoHS compliant and free of halogene substances.

## Copyrights

Copyright © 1997-2009, austriamicrosystems AG, Schloss Premstaetten, 8141 Unterpremstaetten, Austria-Europe. Trademarks Registered ®. All rights reserved. The material herein may not be reproduced, adapted, merged, translated, stored, or used without the prior written consent of the copyright owner.

All products and companies mentioned are trademarks or registered trademarks of their respective companies.

## Disclaimer

Devices sold by austriamicrosystems AG are covered by the warranty and patent indemnification provisions appearing in its Term of Sale. austriamicrosystems AG makes no warranty, express, statutory, implied, or by description regarding the information set forth herein or regarding the freedom of the described devices from patent infringement. austriamicrosystems AG reserves the right to change specifications and prices at any time and without notice. Therefore, prior to designing this product into a system, it is necessary to check with austriamicrosystems AG for current information. This product is intended for use in normal commercial applications. Applications requiring extended temperature range, unusual environmental requirements, or high reliability applications, such as military, medical life-support or life-sustaining equipment are specifically not recommended without additional processing by austriamicrosystems AG for each application. For shipments of less than 100 parts the manufacturing flow might show deviations from the standard production flow, such as test flow or test location.

The information furnished here by austriamicrosystems AG is believed to be correct and accurate. However, austriamicrosystems AG shall not be liable to recipient or any third party for any damages, including but not limited to personal injury, property damage, loss of profits, loss of use, interruption of business or indirect, special, incidental or consequential damages, of any kind, in connection with or arising out of the furnishing, performance or use of the technical data herein. No obligation or liability to recipient or any third party shall arise or flow out of austriamicrosystems AG rendering of technical or other services.



## Contact Information

### Headquarters

austriamicrosystems AG  
A-8141 Schloss Premstaetten, Austria

Tel: +43 (0) 3136 500 0  
Fax: +43 (0) 3136 525 01

For Sales Offices, Distributors and Representatives, please visit:

<http://www.austriamicrosystems.com/contact-us>