

**SERIES: AMT10X**
**DESCRIPTION: INCREMENTAL ENCODER**
**FEATURES**

- patented capacitive technology
- 16 dip switch programmable resolutions
- straight (radial) and right-angle (axial) versions
- 9 different mounting hole options for AMT102
- 6 different mounting hole options for AMT103
- low power consumption
- line driver output available (CUI-10XE-10)
- -40°C to 100°C operating temperature
- TTL voltage output
- modular package

**ELECTRICAL SPECIFICATIONS**

output phase difference	90° (A ch leads B ch in CW direction viewed from front)
output current	5 mA max.
output waveform	TTL voltage square wave
output signals	A, B, Z <sup>1</sup> phase ( $\bar{A}$ , $\bar{B}$ , $\bar{C}$ line driver available with CUI-10XE-10)
current consumption	6 mA typ., 10 mA max.
supply voltage	3.6 ~ 5.5 V dc
output resolution (ppr) <sup>2</sup>	48, 96, 100, 125, 192, 200, 250, 256, 384, 400, 500, 512, 800, 1000, 1024, 2048
frequency response	250 kHz max.
accuracy <sup>3</sup>	±15 arcmin (at 192, 384, 400, 500, 800, 1000, 1024, 2048 ppr) ±30 arcmin (at 96, 200, 250, 512 ppr) ±60 arcmin (at 48, 100, 125, 256 ppr)
max. rotational speed	7500 rpm (at 2048, 1000, 800, 384 ppr) 15000 rpm (at 1024, 500, 400, 192 ppr) 30000 rpm (at 48, 96, 100, 125, 200, 250, 256, 512 ppr)

1. Some stepper motors may leak a magnetic field causing the AMT index pulse to not function properly.

2. All resolutions stated are before quadrature decoding. (example: 1000 ppr x 4 = 4000 counts)

3. Based on full production testing standards and includes all electronic and mechanical based errors, not a computed estimate.

**MECHANICAL SPECIFICATIONS**

mounting hole options	A) 2 each M1.6 holes on 16 mm (0.63") bolt circle B) 2 each #4 holes on 19.05 mm (0.75") bolt circle C) 2 each M1.6 or M2 holes on 20 mm (0.787") bolt circle D) 3 each M1.6 or M2 holes on 20.9 mm (0.823") bolt circle E) 3 each M1.6 or M2 holes on 22 mm (0.866") bolt circle F) 4 each M1.6 or M2 holes on 25.4 mm (1") bolt circle G) 2 each #4 holes on 15.75 mm (0.62") x 20.96 (0.825") hole layout* H) 2 each #4 holes on 32.43 mm (1.277") bolt circle* I) 2 each #4 holes on 46.03 mm (1.812") bolt circle*	
weight	AMT102	20.5 g
	AMT103	14.0 g
vibration proof	50 m/s <sup>2</sup> , 10 ~ 200 Hz, 2 hours each on XYZ	
shock resistance	147 m/s <sup>2</sup> , 11 ms, 2 hours each on XYZ	









**SERIES: AMT10X**
**DESCRIPTION: INCREMENTAL ENCODER**

## ENVIRONMENTAL SPECIFICATIONS

operating temperature	-40° ~ +100° C
storage temperature	-40° ~ +100°C
humidity	30 ~ 95% (no condensation)

## AMT10X-V KIT

In order to provide maximum flexibility for our customers, the AMT10X series is provided in kit form standard. This allows the user to implement the encoder into a range of applications using one sku#, reducing engineering and inventory costs.

SLEEVES								
								
8mm	1/4 inch (6.35mm)	6mm	5mm	3/16 inch (4.76mm)	4mm	1/8 inch (3.175mm)	3mm	2mm
Blue	Snow	Red1	Green1	Yellow1	Gray60	Purple1	Orange	Light Sky Blue

### AMT10X - V

Mounting Version:  
 2 = Straight (radial connector)  
 3 = Right Angle (axial connector)

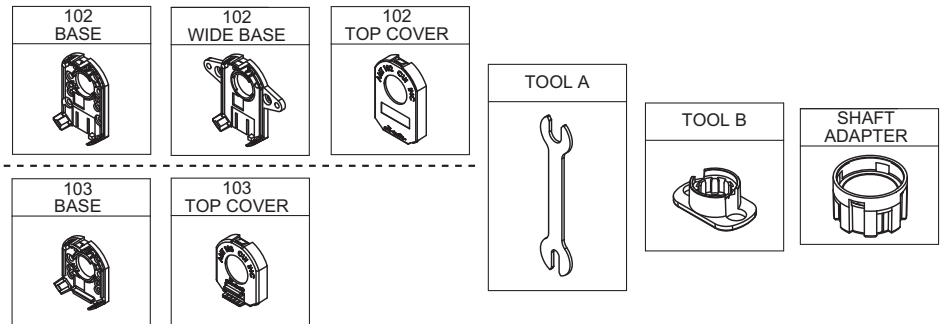

## CUSTOM CONFIG KEY

For customers that prefer a specific AMT10X configuration, please reference the custom configuration key below.

**AMT10X - XXXX - X XXXX - X**

Mounting Version:  
 2 = Straight  
 (radial connector)  
 3 = Right Angle  
 (axial connector)

Resolution:  
 D016 = Dip switch  
 16 resolutions  
 XXXX = Insert set resolution  
 from chart

Index Pulse:  
 I = Index Pulse  
 N = No Index Pulse

Sleeve Bore Diameter:  
 2000 = 2 mm  
 3000 = 3 mm  
 3175 = 3.175 mm (1/8")  
 4000 = 4 mm  
 4760 = 4.76 mm (3/16")  
 5000 = 5 mm  
 6000 = 6 mm  
 6350 = 6.35 mm (1/4")  
 8000 = 8 mm

Mounting Base Plate:  
 S = Standard base plate  
 (mounting hole options A~F, G on AMT 102)  
 W = Wide base plate (**AMT 102 Only**)\*  
 (mounting hole options G~H)

\*If ordering wide base plate, standard base plate is included.

**SERIES: AMT10X**
**DESCRIPTION: INCREMENTAL ENCODER**
**RESOLUTION SETTINGS**

**0 = On, 1 = Off**

Resolution (PPR)	Maximum RPM	4	3	2	1
2048	7500	1	1	1	1
1000	7500	1	1	1	0
800	7500	1	1	0	1
384	7500	1	1	0	0
1024	15000	1	0	1	1
500	15000	1	0	1	0
400	15000	1	0	0	1
192	15000	1	0	0	0
512	30000	0	1	1	1
250	30000	0	1	1	0
200	30000	0	1	0	1
96	30000	0	1	0	0
256	30000	0	0	1	1
125	30000	0	0	1	0
100	30000	0	0	0	1
48	30000	0	0	0	0

**DIP switch:**

Example setting: 500

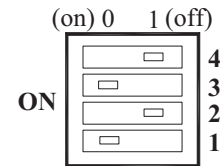
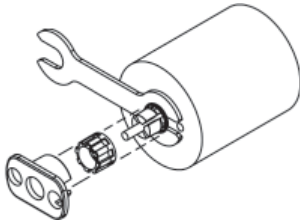
**ASSEMBLY PROCEDURE**
**STEP 1**

1. Insert Tool A as a spacer that defines the distance to the mounting surface.
2. Slide appropriate sized Sleeve over shaft all the way down to Tool A.
3. Slide Shaft Adaptor over Sleeve.
4. Use Tool B to press Shaft Adaptor over Sleeve until flush with Tool A.

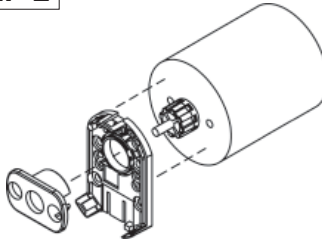
**STEP 2**

5. Remove Tools A and B.
6. Place Base on motor, with Tool B used as a centering tool.

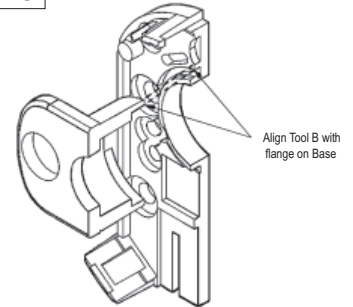
**STEP 3**

- 6a. Align Tool B with flange on Base.
- 6b. Slide Base and Tool B onto motor, centering onto the Shaft Adaptor.

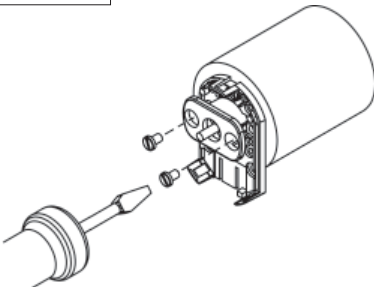
**STEP 4**



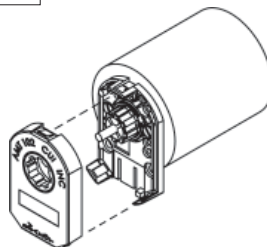



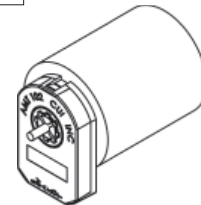







7. Fasten the Base on the motor.
8. Remove Tool B.

**STEP 5**

9. Slide the Top Cover onto the Base, carefully observing that the teeth of the Shaft Adaptor align with the grooves in the hub.

**STEP 6**

10. Make sure the snaps are fully engaged and the Top Cover is flush with the Base.
11. When assembly is finished, the Shaft Adaptor should be about flush with the front of the Encoder and the Motor Shaft should rotate freely.

SLEEVES		SHAFT ADAPTER
	2mm Light Sky Blue	
	3mm Orange	<b>103 BASE</b> 
	1/8 inch (3.175mm) Purple1	<b>103 TOP COVER</b> 
	4mm Gray60	<b>TOOL A</b> 
	3/16 inch (4.76mm) Yellow1	<b>TOOL B</b> 
	5mm Green1	
	6mm Red1	
	1/4 inch (6.35mm) Snow	
	8mm Blue	

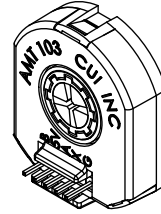
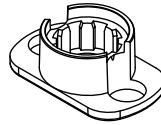
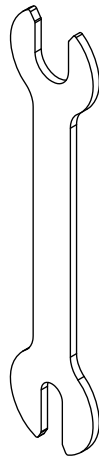

ASSEMBLY

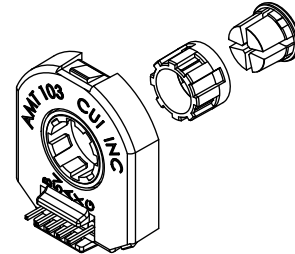

PIN-OUT	
PIN	DESCRIPTION
B	B CHANNEL
5V	+5VDC POWER
A	A CHANNEL
X	INDEX OUPUT
G	GROUND

MATING CONNECTOR  
AMP 3-640440-5

CABLES AVAILABLE  
(SOLD SEPERATELY)











20050 SW 112th Ave.  
Tualatin, OR 97062  
Phone: 503-612-2300  
800-275-4899  
Fax: 503-612-2383  
Website: www.cui.com

AMT103-V comes with all items shown: all Sleeve sizes, Shaft Adapter, Base, Top Cover, Tool A, Tool B, Index Pulse, and 16 Resolution Dip Switch.

PC FILE NAME:  
AMT103-V-REV-E

COPYRIGHT 2008 BY CUI INC.

TITLE: AMT103-V	REV: E
PART NO. AMT103-V	UNITS: MM [INCHES]
DRAWN BY: ZRJ	APPROVED BY: SCALE: N/A

SLEEVES		
	2mm	Light Sky Blue
	3mm	Orange
	1/8 inch (3.175mm)	Purple1
	4mm	Gray60
	3/16 inch (4.76mm)	Yellow1
	5mm	Green1
	6mm	Red1
	1/4 inch (6.35mm)	Snow
	8mm	Blue

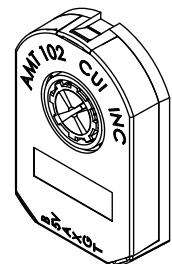
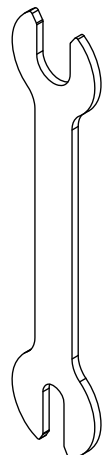
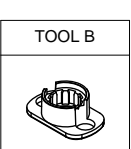
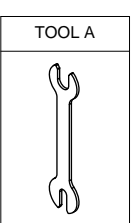
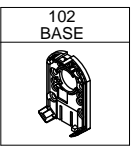
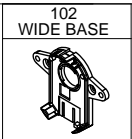
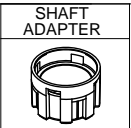

ASSEMBLY

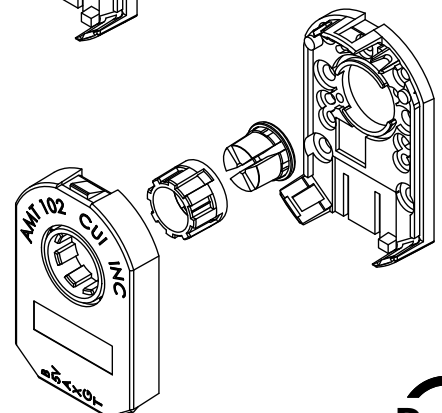
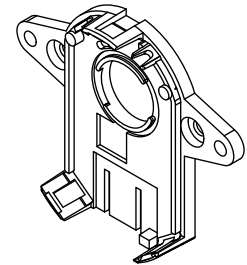
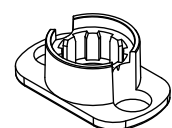

PIN-OUT	
PIN	DESCRIPTION
B	B CHANNEL
5V	+5VDC POWER
A	A CHANNEL
X	INDEX OUPUT
G	GROUND
T	FOR FUTURE USE

MATING CONNECTOR  
MOLEX 50-57-9405 HOUSING  
MOLEX 16-02-0086 TERMINALS

CABLES AVAILABLE  
(SOLD SEPERATELY)



20050 SW 112th Ave.  
Tualatin, OR 97062  
Phone: 503-612-2300  
800-275-4899  
Fax: 503-612-2383  
Website: www.cui.com

AMT102-V comes with all items shown: all Sleeve sizes, Shaft Adapter, Base, Wide Base, Top Cover, Tool A, Tool B, Index Pulse, and 16 Resolution Dip Switch.

PC FILE NAME:  
AMT102-V-REV-C

COPYRIGHT 2007 BY CUI INC.

TITLE: AMT102-V	REV: C
PART NO. AMT102-V	UNITS: MM [INCHES]
DRAWN BY: ZRJ	APPROVED BY: SCALE: N/A

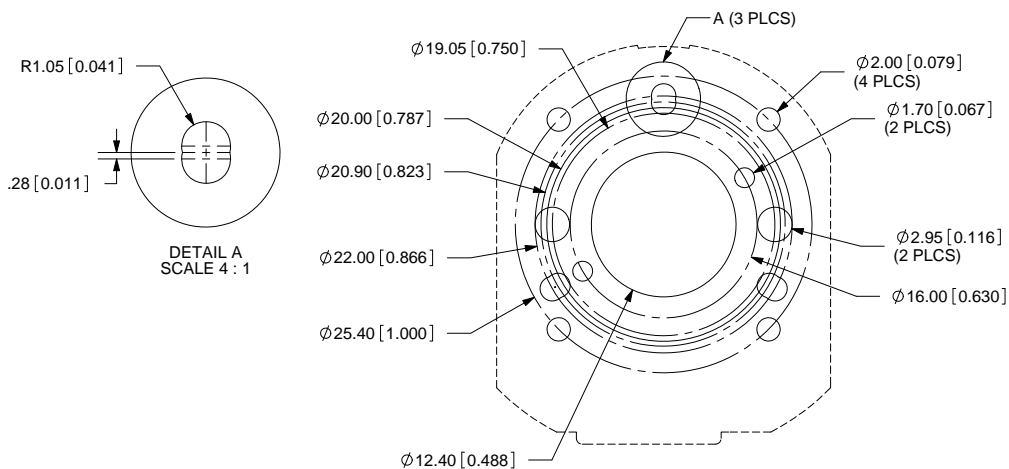
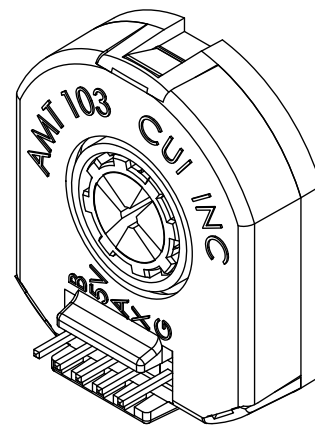
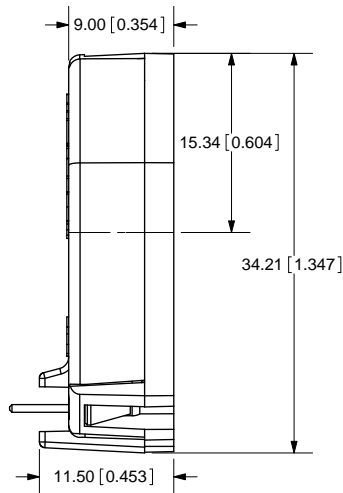
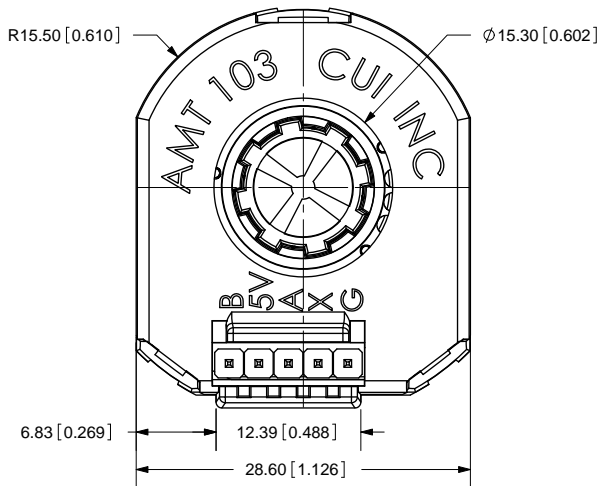

TOLERANCE:  
 $\pm 0.05\text{mm}$  UNLESS OTHERWISE  
 SPECIFIED



20050 SW 112th Ave.  
 Tualatin, OR 97062  
 Phone: 503-612-2300  
 800-275-4899  
 Fax: 503-612-2383  
 Website: www.cui.com

TITLE: AMT103 DIMENSION DRAWING		REV: D
PART NO. AMT103	UNITS: MM [INCHES]	
DRAWN BY: ZRJ	APPROVED BY:	SCALE: 2:1

PC FILE NAME:  
 AMT103-dim-REV-D

COPYRIGHT 2008 BY CUI INC.

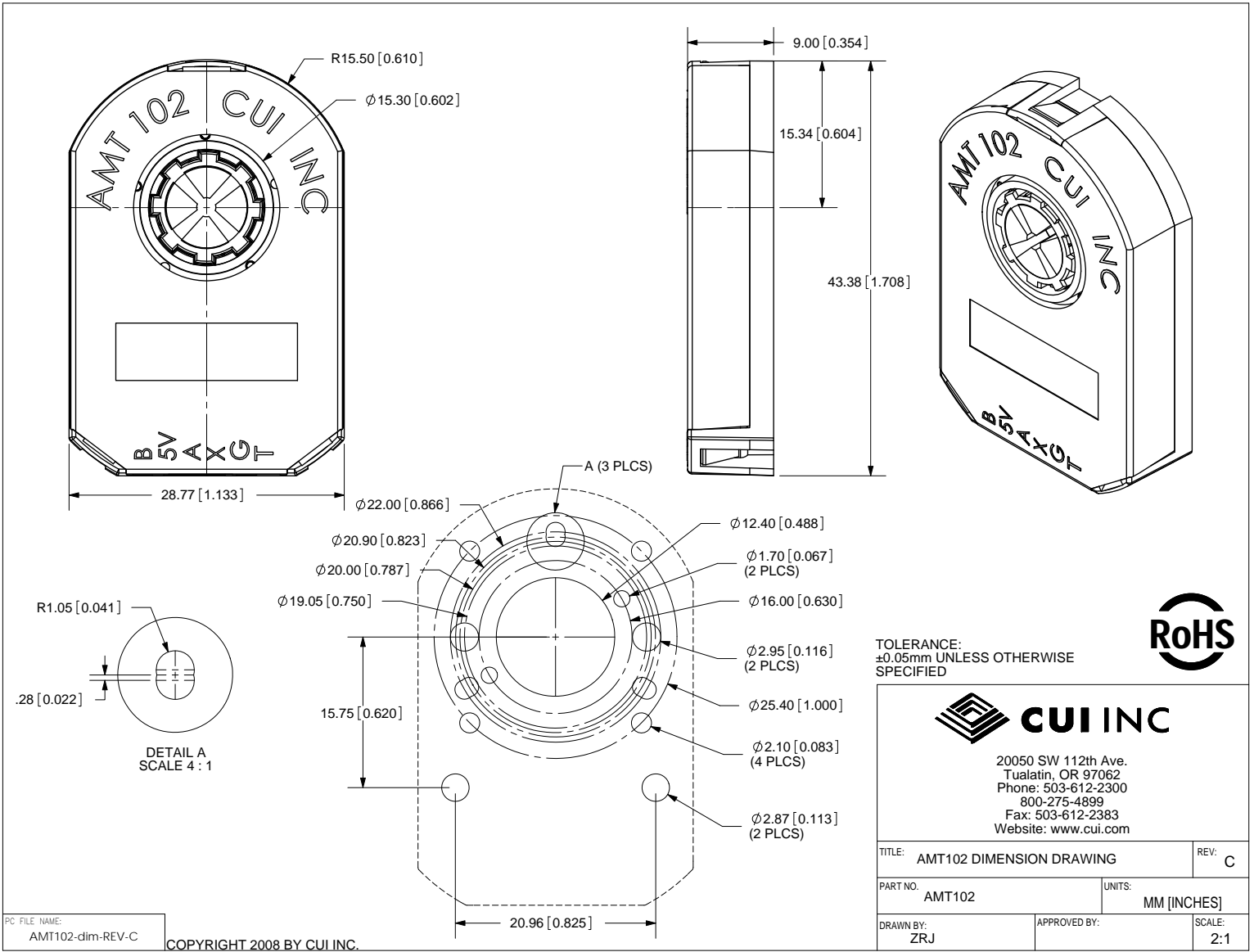

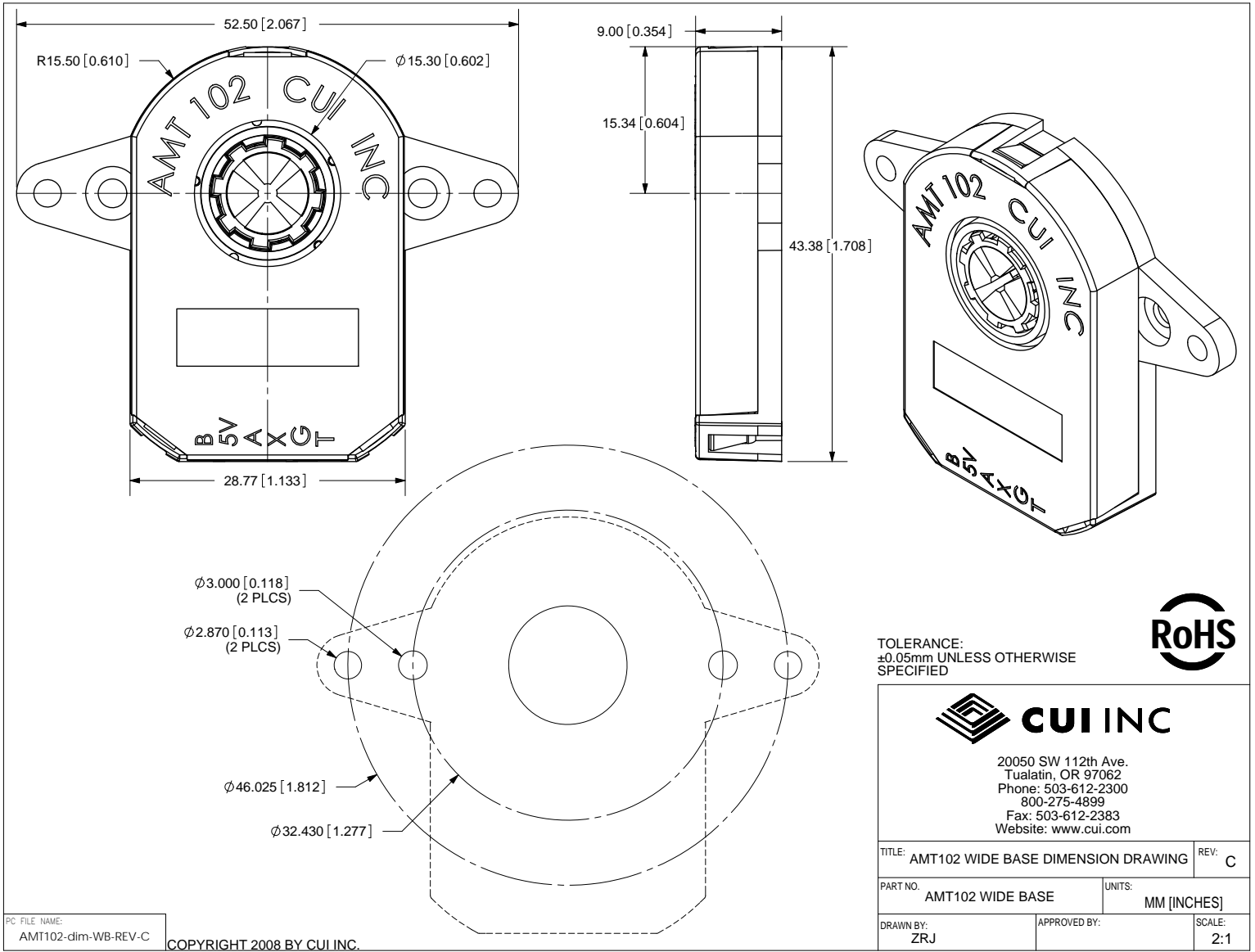

TOLERANCE:  
±0.05mm UNLESS OTHERWISE  
SPECIFIED



20050 SW 112th Ave.  
Tualatin, OR 97062  
Phone: 503-612-2300  
800-275-4899  
Fax: 503-612-2383  
Website: www.cui.com

TITLE: AMT102 WIDE BASE DIMENSION DRAWING		REV: C
PART NO. AMT102 WIDE BASE	UNITS: MM [INCHES]	
DRAWN BY: ZRJ	APPROVED BY:	SCALE: 2:1

PC FILE NAME: AMT102-dim-WB-REV-C  
COPYRIGHT 2008 BY CUI INC.