

**SERIES:** ACZ11

**DESCRIPTION:** mechanical incremental encoder

## ELECTRICAL SPECIFICATIONS

parameter	conditions/description
output waveform	square wave
output signals	A, B phase
current consumption	10 mA
output phase difference	T1, T2, T3, T4 $\geq$ 3.5 ms @ 60 rpm (see output waveform)
supply voltage	5 V dc max.
output resolution	12, 15, 20, 30 ppr
switch rating	12 V dc, 50 mA (ACZ11BRXE models only)
insulation resistance	300 V dc, 100 M $\Omega$
withstand voltage	300 V ac

## MECHANICAL SPECIFICATIONS

parameter	conditions/description	min	nom	max	units
shaft load	axial			8	kgf
rotational torque	with detent click	60	140	220	gf·cm
	without detent click	60	80	100	gf·cm
push switch operational force	(ACZ11BRXE models only)	300		900	gf·cm
push switch life	(ACZ11BRXE models only)			50,000	cycles
rotational life				30,000	cycles

## ENVIRONMENTAL SPECIFICATIONS

parameter	conditions/description	min	nom	max	units
operating temperature		-10		65	$^{\circ}$ C
storage temperature		-40		75	$^{\circ}$ C
humidity		85			% RH
vibration	0.75 mm max. travel for 2 hours	10		55	Hz

## PART NUMBER KEY

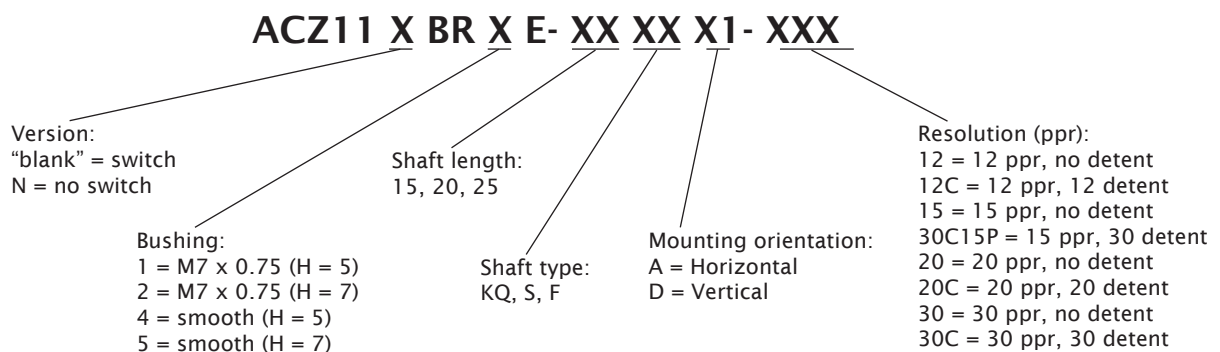

SERIES: ACZ11

DESCRIPTION: mechanical incremental encoder

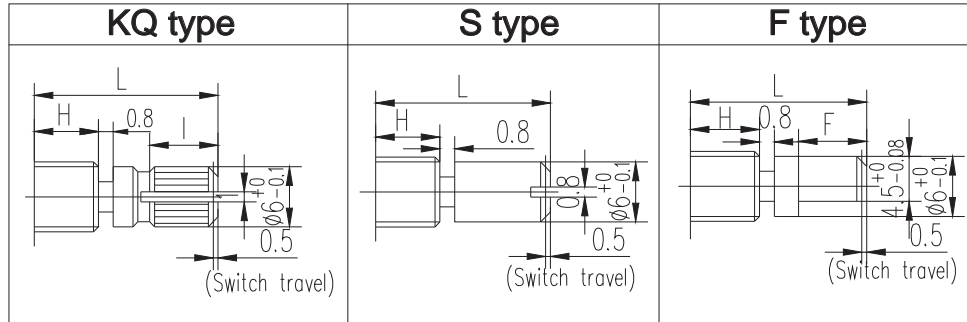
**SHAFT OPTIONS**

**BUSHING**

Condition	H
1 M7-P0.75	5
2 M7-P0.75	7
4 smooth	5
5 smooth	7

switch travel for ACZ11BRXE only

H=5

	15KQ	20KQ	25KQ
L	15	20	25
I	7	10	12

H=5

	15S	20S	25S
L	15	20	25

H=5

	15F	20F	25F
L	15	20	25
F	8	12	12

H=7

	15KQ	20KQ	25KQ
L	15	20	25
I	5	8.5	10

H=7

	15S	20S	25S
L	15	20	25

H=7

	15F	20F	25F
L	15	20	25
F	8	12	12

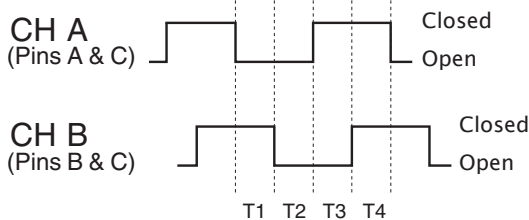
**OUTPUT WAVEFORM**

CW direction (@ 60 rpm)

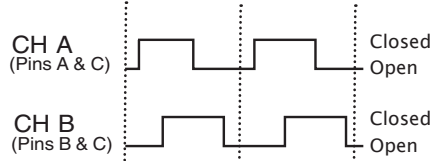
**DETENT POSITIONS**
**Model 12C & 20C**

CW direction →

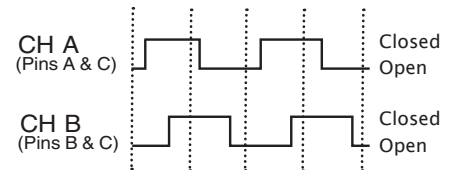
**Model 15P30C**

CW direction →

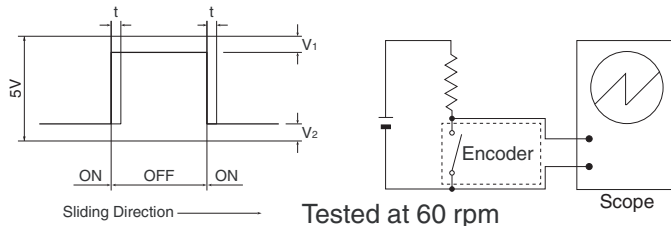
**SLIDING NOISE**
 $t = \text{Masking time to avoid chatter (5mS)}$   $V_1 = V_2 = 1V \text{ max.}$ 

Tested at 60 rpm

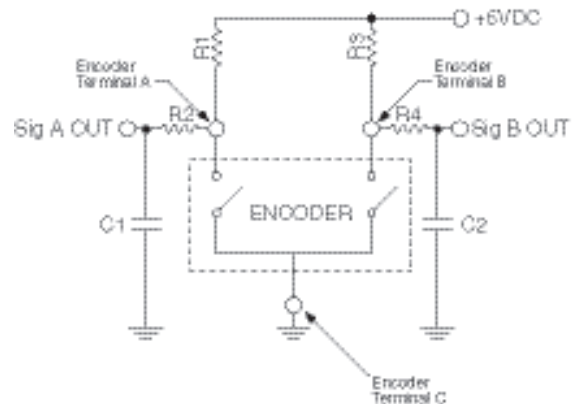
**SUGGESTED FILTER**

 $R1, R2, R3, R4 = 10k\Omega$   
 $C1, C2 = 0.01\mu F$

SERIES: ACZ11

DESCRIPTION: mechanical incremental encoder

**MECHANICAL DRAWING (horizontal)**

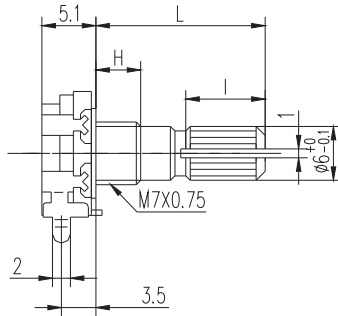
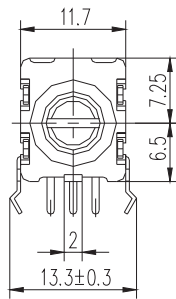
ACZ11NBRXE



PANEL CUT-OUT

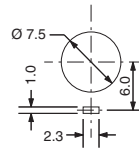

PCB LAYOUT

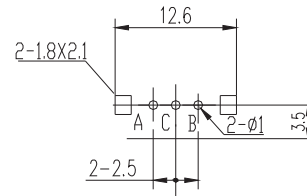

ACZ11BRXE

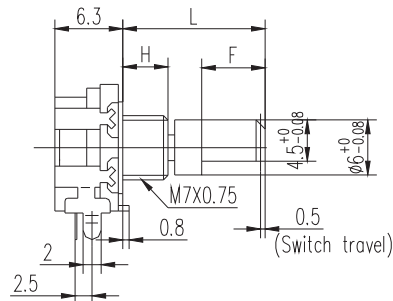
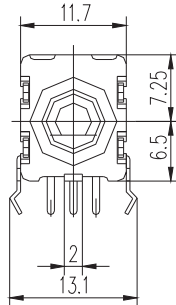

PANEL CUT-OUT

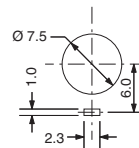

PCB LAYOUT

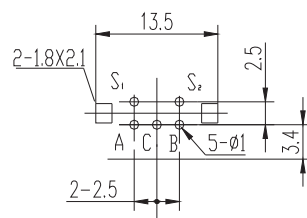
**MECHANICAL DRAWING (vertical)**

ACZ11NBRXE

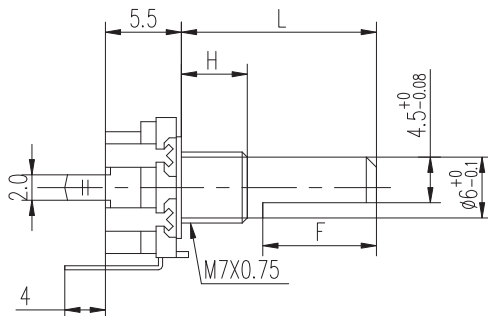
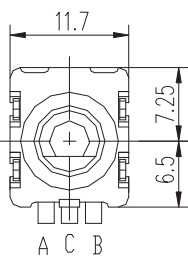

PANEL CUT-OUT

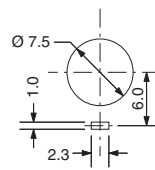

PCB LAYOUT

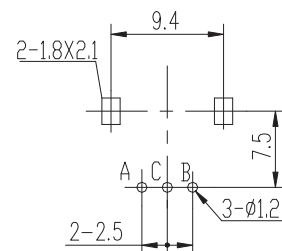

ACZ11BRXE

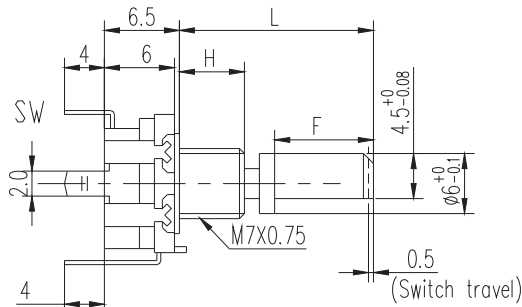
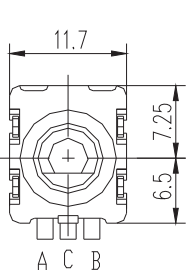

PANEL CUT-OUT

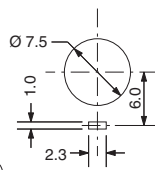

PCB LAYOUT

