

SERIES: ACZ11

DESCRIPTION: mechanical incremental encoder

ELECTRICAL SPECIFICATIONS

| parameter | conditions/description |
|-------------------------|---|
| output waveform | square wave |
| output signals | A, B phase |
| current consumption | 10 mA |
| output phase difference | T1, T2, T3, T4 \geq 3.5 ms @ 60 rpm (see output waveform) |
| supply voltage | 5 V dc max. |
| output resolution | 12, 15, 20, 30 ppr |
| switch rating | 12 V dc, 50 mA (ACZ11BRXE models only) |
| insulation resistance | 300 V dc, 100 M Ω |
| withstand voltage | 300 V ac |

MECHANICAL SPECIFICATIONS

| parameter | conditions/description | min | nom | max | units |
|-------------------------------|-------------------------|-----|-----|--------|--------|
| shaft load | axial | | | 8 | kgf |
| rotational torque | with detent click | 60 | 140 | 220 | gf·cm |
| | without detent click | 60 | 80 | 100 | gf·cm |
| push switch operational force | (ACZ11BRXE models only) | 300 | | 900 | gf·cm |
| push switch life | (ACZ11BRXE models only) | | | 50,000 | cycles |
| rotational life | | | | 30,000 | cycles |

ENVIRONMENTAL SPECIFICATIONS

| parameter | conditions/description | min | nom | max | units |
|-----------------------|---------------------------------|-----|-----|-----|--------------|
| operating temperature | | -10 | | 65 | $^{\circ}$ C |
| storage temperature | | -40 | | 75 | $^{\circ}$ C |
| humidity | | 85 | | | % RH |
| vibration | 0.75 mm max. travel for 2 hours | 10 | | 55 | Hz |

PART NUMBER KEY

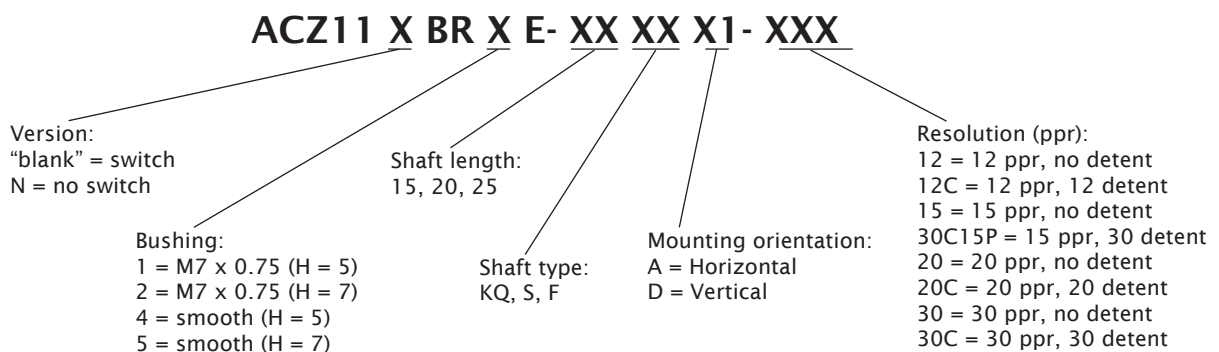

SERIES: ACZ11

DESCRIPTION: mechanical incremental encoder

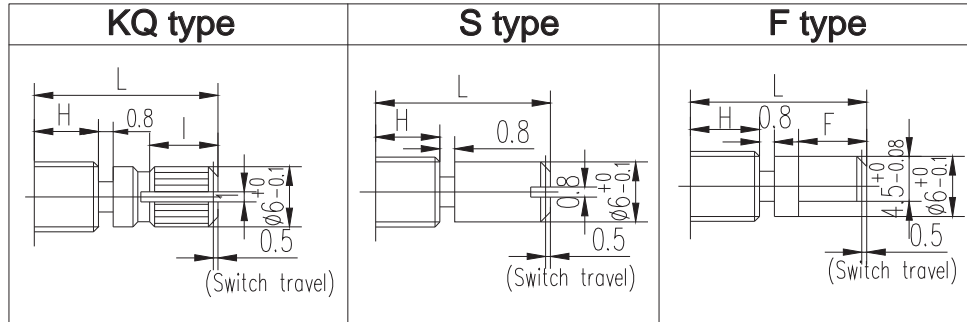
SHAFT OPTIONS

| BUSHING | | |
|-----------|----------|---|
| Condition | H | |
| 1 | M7-P0.75 | 5 |
| 2 | M7-P0.75 | 7 |
| 4 | smooth | 5 |
| 5 | smooth | 7 |

switch travel for ACZ11BRXE only

| H=5 | | | |
|-----|------|------|------|
| | 15KQ | 20KQ | 25KQ |
| L | 15 | 20 | 25 |
| I | 7 | 10 | 12 |

| H=5 | | | |
|-----|-----|-----|-----|
| | 15S | 20S | 25S |
| L | 15 | 20 | 25 |

| H=5 | | | |
|-----|-----|-----|-----|
| | 15F | 20F | 25F |
| L | 15 | 20 | 25 |
| F | 8 | 12 | 12 |

| H=7 | | | |
|-----|------|------|------|
| | 15KQ | 20KQ | 25KQ |
| L | 15 | 20 | 25 |
| I | 5 | 8.5 | 10 |

| H=7 | | | |
|-----|-----|-----|-----|
| | 15S | 20S | 25S |
| L | 15 | 20 | 25 |

| H=7 | | | |
|-----|-----|-----|-----|
| | 15F | 20F | 25F |
| L | 15 | 20 | 25 |
| F | 8 | 12 | 12 |

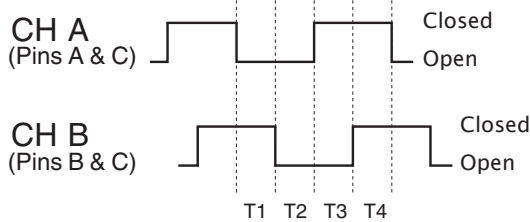
OUTPUT WAVEFORM

CW direction (@ 60 rpm)

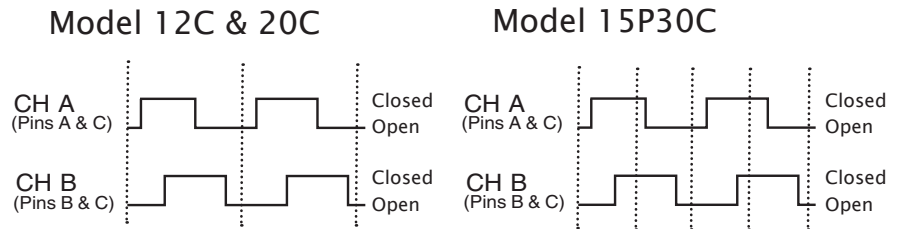
DETENT POSITIONS

CW direction →

CW direction →

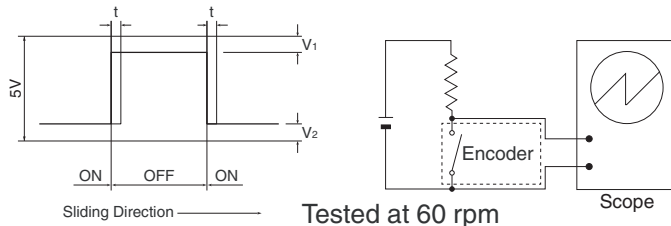
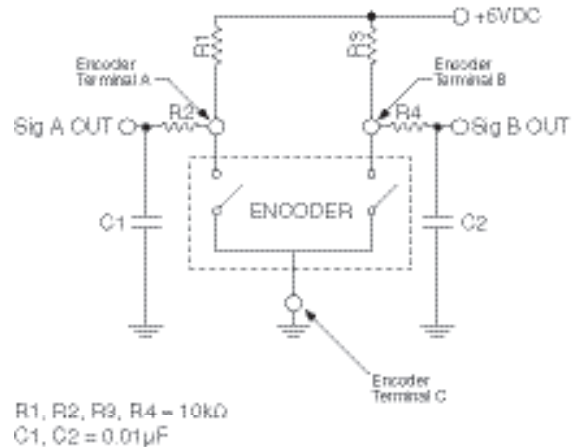
SLIDING NOISE
 $t = \text{Masking time to avoid chatter (5mS)}$ $V_1 = V_2 = 1V \text{ max.}$

SUGGESTED FILTER

SERIES: ACZ11

DESCRIPTION: mechanical incremental encoder

MECHANICAL DRAWING (horizontal)

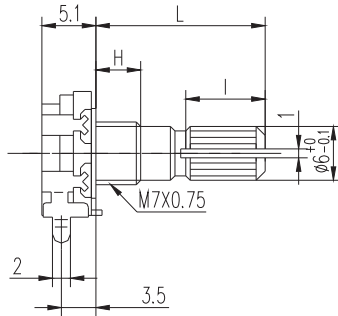
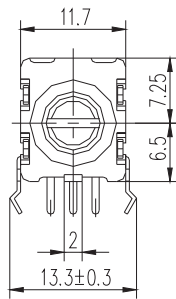
ACZ11NBRXE



PANEL CUT-OUT

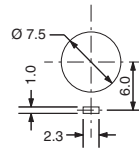

PCB LAYOUT

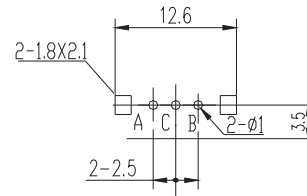

ACZ11BRXE

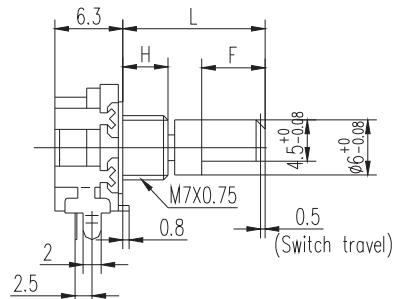
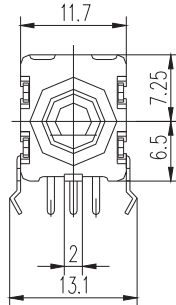

PANEL CUT-OUT

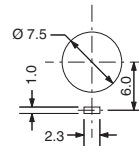

PCB LAYOUT

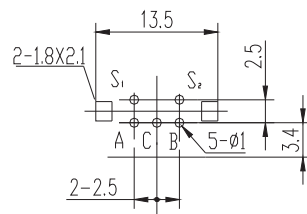
MECHANICAL DRAWING (vertical)

ACZ11NBRXE

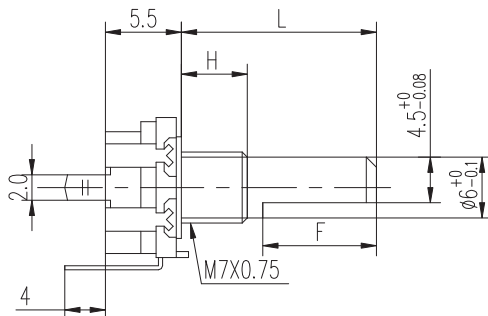
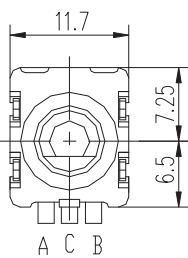

PANEL CUT-OUT

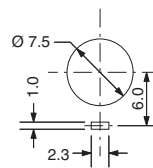

PCB LAYOUT

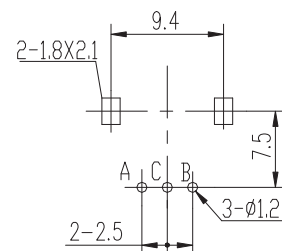

ACZ11BRXE

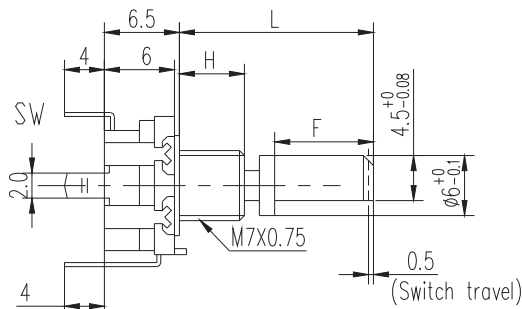
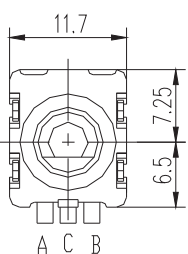

PANEL CUT-OUT

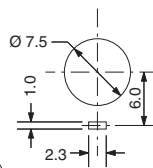

PCB LAYOUT

