

DATA SHEET

74AHC1G04; 74AHCT1G04 **Inverter**

Product specification
Supersedes data of 2002 May 27

2003 Sep 04

Inverter

74AHC1G04; 74AHCT1G04

FEATURES

- Symmetrical output impedance
- High noise immunity
- ESD protection:
 - HBM EIA/JESD22-A114-A exceeds 2000 V
 - MM EIA/JESD22-A115-A exceeds 200 V
 - CDM EIA/JESD22-C101 exceeds 1000 V.
- Low power dissipation
- Balanced propagation delays
- Very small 5-pin package
- Specified from -40 to $+85$ °C and -40 to $+125$ °C.

DESCRIPTION

The 74AHC1G04/74AHCT1G04 are high-speed Si-gate CMOS devices.

The 74AHC1G04/74AHCT1G04 provides the inverting buffer.

QUICK REFERENCE DATA

GND = 0 V; $T_{amb} = 25$ °C; $t_r = t_f \leq 3.0$ ns.

SYMBOL	PARAMETER	CONDITIONS	TYPICAL		UNIT
			74AHC1G04	74AHCT1G04	
t_{PHL}/t_{PLH}	propagation delay input A to output Y	$C_L = 15$ pF; $V_{CC} = 5$ V	3.1	3.4	ns
C_i	input capacitance		1.5	1.5	pF
C_{PD}	power dissipation capacitance	$C_L = 50$ pF; $f = 1$ MHz; notes 1 and 2	15	16	pF

Notes

1. C_{PD} is used to determine the dynamic power dissipation (P_D in μ W).

$$P_D = C_{PD} \times V_{CC}^2 \times f_i \times N + \sum(C_L \times V_{CC}^2 \times f_o) \text{ where:}$$

f_i = input frequency in MHz;

f_o = output frequency in MHz;

C_L = output load capacitance in pF;

V_{CC} = supply voltage in Volts;

N = total load switching outputs;

$\sum(C_L \times V_{CC}^2 \times f_o)$ = sum of outputs.

2. The condition is $V_I = \text{GND to } V_{CC}$.

Inverter

74AHC1G04; 74AHCT1G04

FUNCTION TABLE

See note 1.

INPUT	OUTPUT
A	Y
L	H
H	L

Note

- H = HIGH voltage level;
L = LOW voltage level.

ORDERING AND PACKAGE INFORMATION

TYPE NUMBER	PACKAGES					
	TEMPERATURE RANGE	PINS	PACKAGE	MATERIAL	CODE	MARKING
74AHC1G04GW	-40 to +125 °C	5	SC-88A	plastic	SOT353	AC
74AHCT1G04GW	-40 to +125 °C	5	SC-88A	plastic	SOT353	CC
74AHC1G04GV	-40 to +125 °C	5	SC-74A	plastic	SOT753	A04
74AHCT1G04GV	-40 to +125 °C	5	SC-74A	plastic	SOT753	C04

PINNING

PIN	SYMBOL	DESCRIPTION
1	n.c.	not connected
2	A	data input A
3	GND	ground (0 V)
4	Y	data output Y
5	V _{CC}	supply voltage

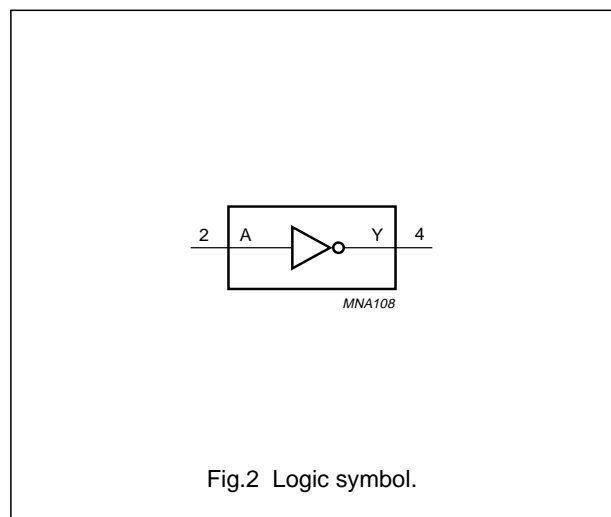
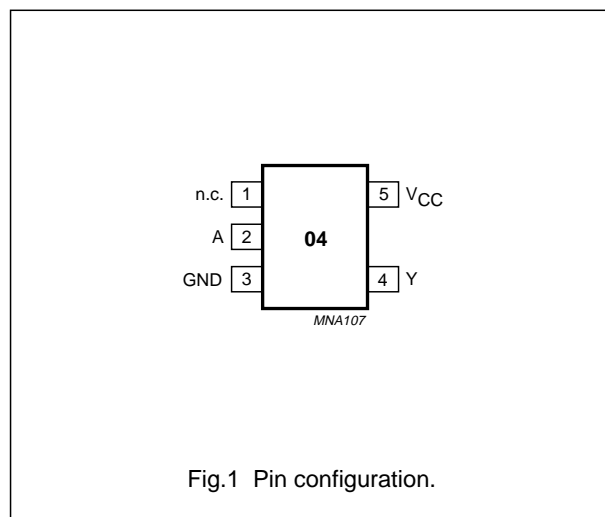

Inverter

74AHC1G04; 74AHCT1G04

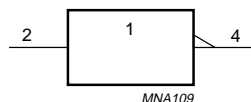

Fig.3 IEC logic symbol.

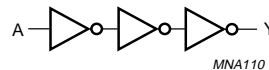

Fig.4 Logic diagram.

RECOMMENDED OPERATING CONDITIONS

SYMBOL	PARAMETER	CONDITIONS	74AHC1G04			74AHCT1G04			UNIT
			MIN.	TYP.	MAX.	MIN.	TYP.	MAX.	
V_{CC}	supply voltage		2.0	5.0	5.5	4.5	5.0	5.5	V
V_I	input voltage		0	–	5.5	0	–	5.5	V
V_O	output voltage		0	–	V_{CC}	0	–	V_{CC}	V
T_{amb}	operating ambient temperature	see DC and AC characteristics per device	–40	+25	+125	–40	+25	+125	°C
$t_r, t_f (\Delta t/\Delta f)$	input rise and fall times	$V_{CC} = 3.3 \pm 0.3$ V	–	–	100	–	–	–	ns/V
		$V_{CC} = 5 \pm 0.5$ V	–	–	20	–	–	20	ns/V

LIMITING VALUES

In accordance with the Absolute Maximum Rating System (IEC 60134); voltages are referenced to GND (ground = 0 V).

SYMBOL	PARAMETER	CONDITIONS	MIN.	MAX.	UNIT
V_{CC}	supply voltage		–0.5	+7.0	V
V_I	input voltage		–0.5	+7.0	V
I_{IK}	input diode current	$V_I < -0.5$ V	–	–20	mA
I_{OK}	output diode current	$V_O < -0.5$ or $V_O > V_{CC} + 0.5$ V; note 1	–	±20	mA
I_O	output source or sink current	-0.5 V < V_O < $V_{CC} + 0.5$ V	–	±25	mA
I_{CC}, I_{GND}	V_{CC} or GND current		–	±75	mA
T_{stg}	storage temperature		–65	+150	°C
P_D	power dissipation	$T_{amb} = -40$ to $+125$ °C	–	250	mW

Note

1. The input and output voltage ratings may be exceeded if the input and output current ratings are observed.

Inverter

74AHC1G04; 74AHCT1G04

DC CHARACTERISTICS

Type 74AHC1G04

At recommended operating conditions; voltages are referenced to GND (ground = 0 V).

SYMBOL	PARAMETER	TEST CONDITIONS		MIN.	TYP.	MAX.	UNIT
		OTHER	V _{CC} (V)				
T_{amb} = 25 °C							
V _{IH}	HIGH-level input voltage		2.0	1.5	–	–	V
			3.0	2.1	–	–	V
			5.5	3.85	–	–	V
V _{IL}	LOW-level input voltage		2.0	–	–	0.5	V
			3.0	–	–	0.9	V
			5.5	–	–	1.65	V
V _{OH}	HIGH-level output voltage	V _I = V _{IH} or V _{IL} I _O = –50 µA	2.0	1.9	2.0	–	V
		I _O = –50 µA	3.0	2.9	3.0	–	V
		I _O = –50 µA	4.5	4.4	4.5	–	V
		I _O = –4.0 mA	3.0	2.58	–	–	V
		I _O = –8.0 mA	4.5	3.94	–	–	V
V _{OL}	LOW-level output voltage	V _I = V _{IH} or V _{IL} I _O = 50 µA	2.0	–	0	0.1	V
		I _O = 50 µA	3.0	–	0	0.1	V
		I _O = 50 µA	4.5	–	0	0.1	V
		I _O = 4.0 mA	3.0	–	–	0.36	V
		I _O = 8.0 mA	4.5	–	–	0.36	V
I _{LI}	input leakage current	V _I = V _{CC} or GND	5.5	–	–	0.1	µA
I _{CC}	quiescent supply current	V _I = V _{CC} or GND; I _O = 0	5.5	–	–	10	µA
C _I	input capacitance		–	–	1.5	10	pF

Inverter

74AHC1G04; 74AHCT1G04

SYMBOL	PARAMETER	TEST CONDITIONS		MIN.	TYP.	MAX.	UNIT
		OTHER	V _{CC} (V)				
T_{amb} = -40 to +85 °C							
V _{IH}	HIGH-level input voltage		2.0	1.5	–	–	V
			3.0	2.1	–	–	V
			5.5	3.85	–	–	V
V _{IL}	LOW-level input voltage		2.0	–	–	0.5	V
			3.0	–	–	0.9	V
			5.5	–	–	1.65	V
V _{OH}	HIGH-level output voltage	V _I = V _{IH} or V _{IL} I _O = -50 µA	2.0	1.9	–	–	V
		I _O = -50 µA	3.0	2.9	–	–	V
		I _O = -50 µA	4.5	4.4	–	–	V
		I _O = -4.0 mA	3.0	2.48	–	–	V
		I _O = -8.0 mA	4.5	3.8	–	–	V
V _{OL}	LOW-level output voltage	V _I = V _{IH} or V _{IL} I _O = 50 µA	2.0	–	–	0.1	V
		I _O = 50 µA	3.0	–	–	0.1	V
		I _O = 50 µA	4.5	–	–	0.1	V
		I _O = 4.0 mA	3.0	–	–	0.44	V
		I _O = 8.0 mA	4.5	–	–	0.44	V
I _{LI}	input leakage current	V _I = V _{CC} or GND	5.5	–	–	1.0	µA
I _{CC}	quiescent supply current	V _I = V _{CC} or GND; I _O = 0	5.5	–	–	10	µA
C _I	input capacitance		–	–	–	10	pF

Inverter

74AHC1G04; 74AHCT1G04

SYMBOL	PARAMETER	TEST CONDITIONS		MIN.	TYP.	MAX.	UNIT
		OTHER	V _{CC} (V)				
T_{amb} = -40 to +125 °C							
V _{IH}	HIGH-level input voltage		2.0	1.5	–	–	V
			3.0	2.1	–	–	V
			5.5	3.85	–	–	V
V _{IL}	LOW-level input voltage		2.0	–	–	0.5	V
			3.0	–	–	0.9	V
			5.5	–	–	1.65	V
V _{OH}	HIGH-level output voltage	V _I = V _{IH} or V _{IL} I _O = -50 µA	2.0	1.9	–	–	V
		I _O = -50 µA	3.0	2.9	–	–	V
		I _O = -50 µA	4.5	4.4	–	–	V
		I _O = -4.0 mA	3.0	2.40	–	–	V
		I _O = -8.0 mA	4.5	3.70	–	–	V
V _{OL}	LOW-level output voltage	V _I = V _{IH} or V _{IL} I _O = 50 µA	2.0	–	–	0.1	V
		I _O = 50 µA	3.0	–	–	0.1	V
		I _O = 50 µA	4.5	–	–	0.1	V
		I _O = 4.0 mA	3.0	–	–	0.55	V
		I _O = 8.0 mA	4.5	–	–	0.55	V
I _{LI}	input leakage current	V _I = V _{CC} or GND	5.5	–	–	2.0	µA
I _{CC}	quiescent supply current	V _I = V _{CC} or GND; I _O = 0	5.5	–	–	40	µA
C _I	input capacitance		–	–	–	10	pF

Inverter

74AHC1G04; 74AHCT1G04

Type 74AHCT1G04

At recommended operating conditions; voltages are referenced to GND (ground = 0 V).

SYMBOL	PARAMETER	TEST CONDITIONS		MIN.	TYP.	MAX.	UNIT
		OTHER	V _{CC} (V)				
T_{amb} = 25 °C							
V _{IH}	HIGH-level input voltage		4.5 to 5.5	2.0	–	–	V
V _{IL}	LOW-level input voltage		4.5 to 5.5	–	–	0.8	V
V _{OH}	HIGH-level output voltage	V _I = V _{IH} or V _{IL} I _O = –50 µA I _O = –8.0 mA	4.5	4.4	4.5	–	V
			4.5	3.94	–	–	V
V _{OL}	LOW-level output voltage	V _I = V _{IH} or V _{IL} I _O = 50 µA I _O = 8.0 mA	4.5	–	0	0.1	V
			4.5	–	–	0.36	V
I _{LI}	input leakage current	V _I = V _{IH} or V _{IL}	5.5	–	–	0.1	µA
I _{CC}	quiescent supply current	V _I = V _{CC} or GND; I _O = 0	5.5	–	–	1.0	µA
ΔI _{CC}	additional quiescent supply current per input pin	V _I = 3.4 V; other inputs at V _{CC} or GND; I _O = 0	5.5	–	–	1.35	mA
C _I	input capacitance			–	1.5	10	pF
T_{amb} = –40 to +85 °C							
V _{IH}	HIGH-level input voltage		4.5 to 5.5	2.0	–	–	V
V _{IL}	LOW-level input voltage		4.5 to 5.5	–	–	0.8	V
V _{OH}	HIGH-level output voltage	V _I = V _{IH} or V _{IL} I _O = –50 µA I _O = –8.0 mA	4.5	4.4	–	–	V
			4.5	3.8	–	–	V
V _{OL}	LOW-level output voltage	V _I = V _{IH} or V _{IL} I _O = 50 µA I _O = 8.0 mA	4.5	–	–	0.1	V
			4.5	–	–	0.44	V
I _{LI}	input leakage current	V _I = V _{IH} or V _{IL}	5.5	–	–	1.0	µA
I _{CC}	quiescent supply current	V _I = V _{CC} or GND; I _O = 0	5.5	–	–	10	µA
ΔI _{CC}	additional quiescent supply current per input pin	V _I = 3.4 V; other inputs at V _{CC} or GND; I _O = 0	5.5	–	–	1.5	mA
C _I	input capacitance		–	–	–	10	pF

Inverter

74AHC1G04; 74AHCT1G04

SYMBOL	PARAMETER	TEST CONDITIONS		MIN.	TYP.	MAX.	UNIT
		OTHER	V _{CC} (V)				
T_{amb} = -40 to +125 °C							
V _{IH}	HIGH-level input voltage		4.5 to 5.5	2.0	–	–	V
V _{IL}	LOW-level input voltage		4.5 to 5.5	–	–	0.8	V
V _{OH}	HIGH-level output voltage	V _I = V _{IH} or V _{IL}	4.5	4.4	–	–	V
		I _O = -50 µA I _O = -8.0 mA	4.5	3.70	–	–	V
V _{OL}	LOW-level output voltage	V _I = V _{IH} or V _{IL}	4.5	–	–	0.1	V
		I _O = 50 µA I _O = 8.0 mA	4.5	–	–	0.55	V
I _{LI}	input leakage current	V _I = V _{IH} or V _{IL}	5.5	–	–	2.0	µA
I _{CC}	quiescent supply current	V _I = V _{CC} or GND; I _O = 0	5.5	–	–	40	µA
ΔI _{CC}	additional quiescent supply current per input pin	V _I = 3.4 V; other inputs at V _{CC} or GND; I _O = 0	5.5	–	–	1.5	mA
C _I	input capacitance		–	–	–	10	pF

Inverter

74AHC1G04; 74AHCT1G04

AC CHARACTERISTICS

Type 74AHC1G04

GND = 0 V; $t_r = t_f \leq 3.0$ ns.

SYMBOL	PARAMETER	TEST CONDITIONS			MIN.	TYP.	MAX.	UNIT
		WAVEFORMS	C_L (pF)	V_{CC} (V)				
$T_{amb} = 25\text{ }^\circ\text{C}$								
t_{PHL}/t_{PLH}	propagation delay input A to output Y	see Figs 5 and 6	15	3.0 to 3.6	–	–	7.1	ns
				3.3	–	4.3	–	ns
				4.5 to 5.5	–	–	5.5	ns
				5	–	3.1	–	ns
			50	3.0 to 3.6	–	–	10.6	ns
				3.3	–	6.1	–	ns
				4.5 to 5.5	–	–	7.5	ns
				5	–	4.5	–	ns
$T_{amb} = -40\text{ to }+85\text{ }^\circ\text{C}$								
t_{PHL}/t_{PLH}	propagation delay input A to output Y	see Figs 5 and 6	15	3.0 to 3.6	1.0	–	8.5	ns
				4.5 to 5.5	1.0	–	6.5	ns
			50	3.0 to 3.6	1.0	–	12	ns
				4.5 to 5.5	1.0	–	8.5	ns
$T_{amb} = -40\text{ to }+125\text{ }^\circ\text{C}$								
t_{PHL}/t_{PLH}	propagation delay input A to output Y	see Figs 5 and 6	15	3.0 to 3.6	1.0	–	11.0	ns
				4.5 to 5.5	1.0	–	7.0	ns
			50	3.0 to 3.6	1.0	–	14.5	ns
				4.5 to 5.5	1.0	–	9.5	ns

Inverter

74AHC1G04; 74AHCT1G04

Type 74AHCT1G04

GND = 0 V; $t_r = t_f \leq 3.0$ ns.

SYMBOL	PARAMETER	TEST CONDITIONS			MIN.	TYP.	MAX.	UNIT
		WAVEFORMS	C_L (pF)	V_{CC} (V)				
$T_{amb} = 25\text{ }^\circ\text{C}$								
t_{PHL}/t_{PLH}	propagation delay input A to output Y	see Figs 5 and 6	15	4.5 to 5.5	–	–	6.7	ns
				5	–	3.4	–	ns
			50	4.5 to 5.5	–	–	7.7	ns
				5	–	4.9	–	ns
$T_{amb} = -40\text{ to }+85\text{ }^\circ$								
t_{PHL}/t_{PLH}	propagation delay input A to output Y	see Figs 5 and 6	15	4.5 to 5.5	1.0	–	7.5	ns
			50	4.5 to 5.5	1.0	–	8.5	ns
$T_{amb} = -40\text{ to }+125\text{ }^\circ\text{C}$								
t_{PHL}/t_{PLH}	propagation delay input A to output Y	see Figs 5 and 6	15	4.5 to 5.5	1.0	–	8.5	ns
			50	4.5 to 5.5	1.0	–	10.0	ns

Inverter

74AHC1G04; 74AHCT1G04

AC WAVEFORMS

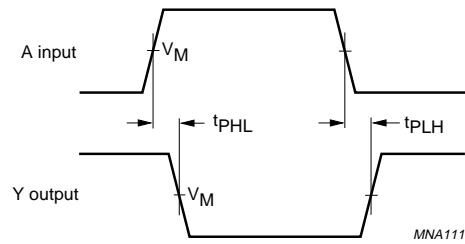

TYPE	V_I INPUT REQUIREMENTS	V_M INPUT	V_M OUTPUT
74AHC1G04	GND to V_{CC}	50% V_{CC}	50% V_{CC}
74AHCT1G04	GND to 3.0 V	1.5 V	50% V_{CC}

Fig.5 Input (A) to output (Y) propagation delays.

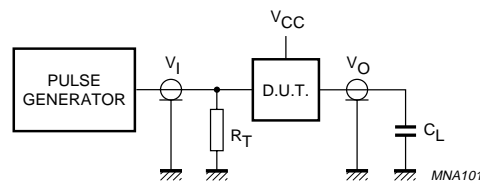

Definitions for test circuit:

C_L = load capacitance including jig and probe capacitance (see Chapter "AC characteristics").

R_T = termination resistance should be equal to the output impedance Z_0 of the pulse generator.

Fig.6 Load circuitry for switching times.

Inverter

74AHC1G04; 74AHCT1G04

PACKAGE OUTLINES

Plastic surface mounted package; 5 leads

SOT353

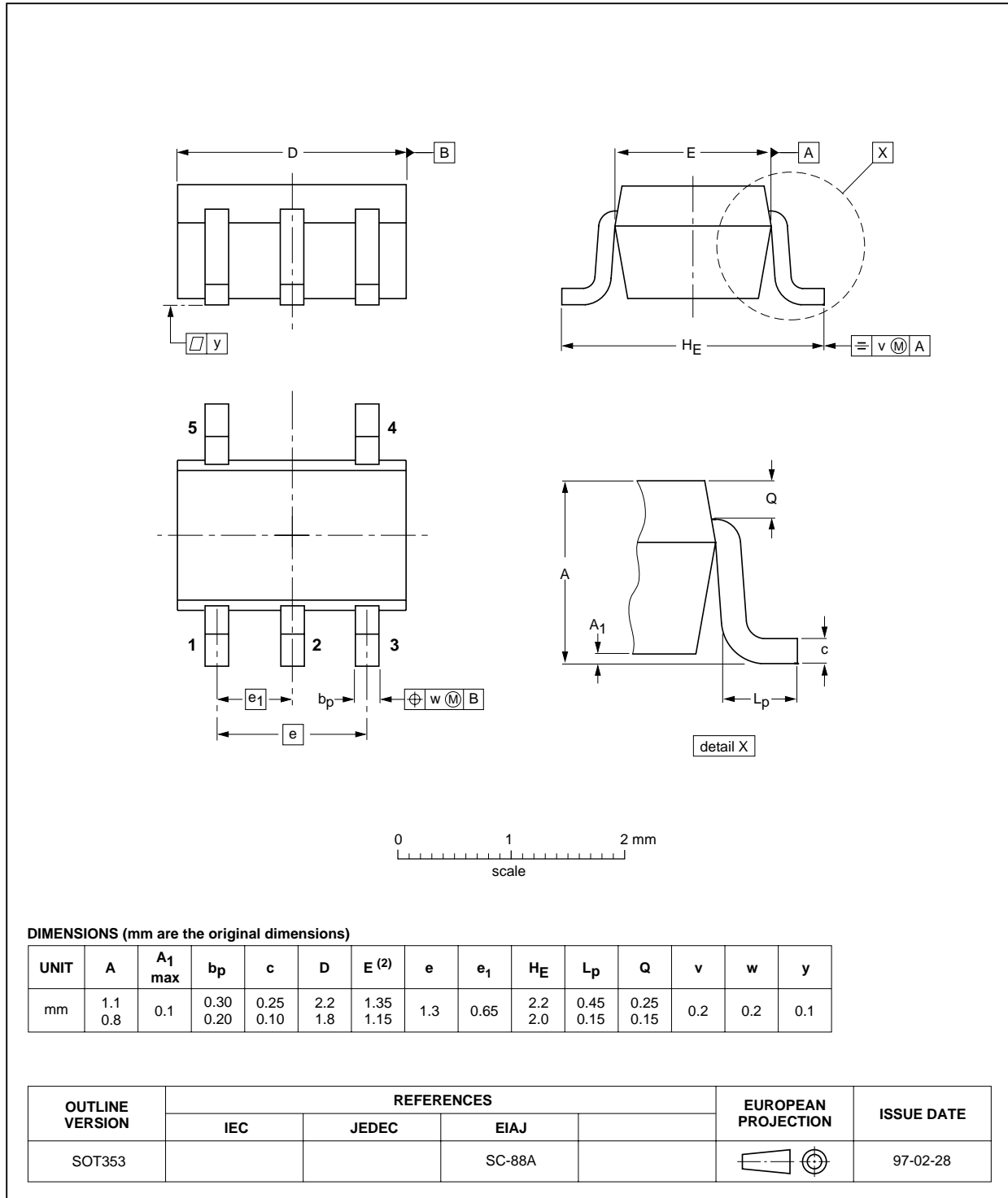

Inverter

74AHC1G04; 74AHCT1G04

Plastic surface mounted package; 5 leads

SOT753

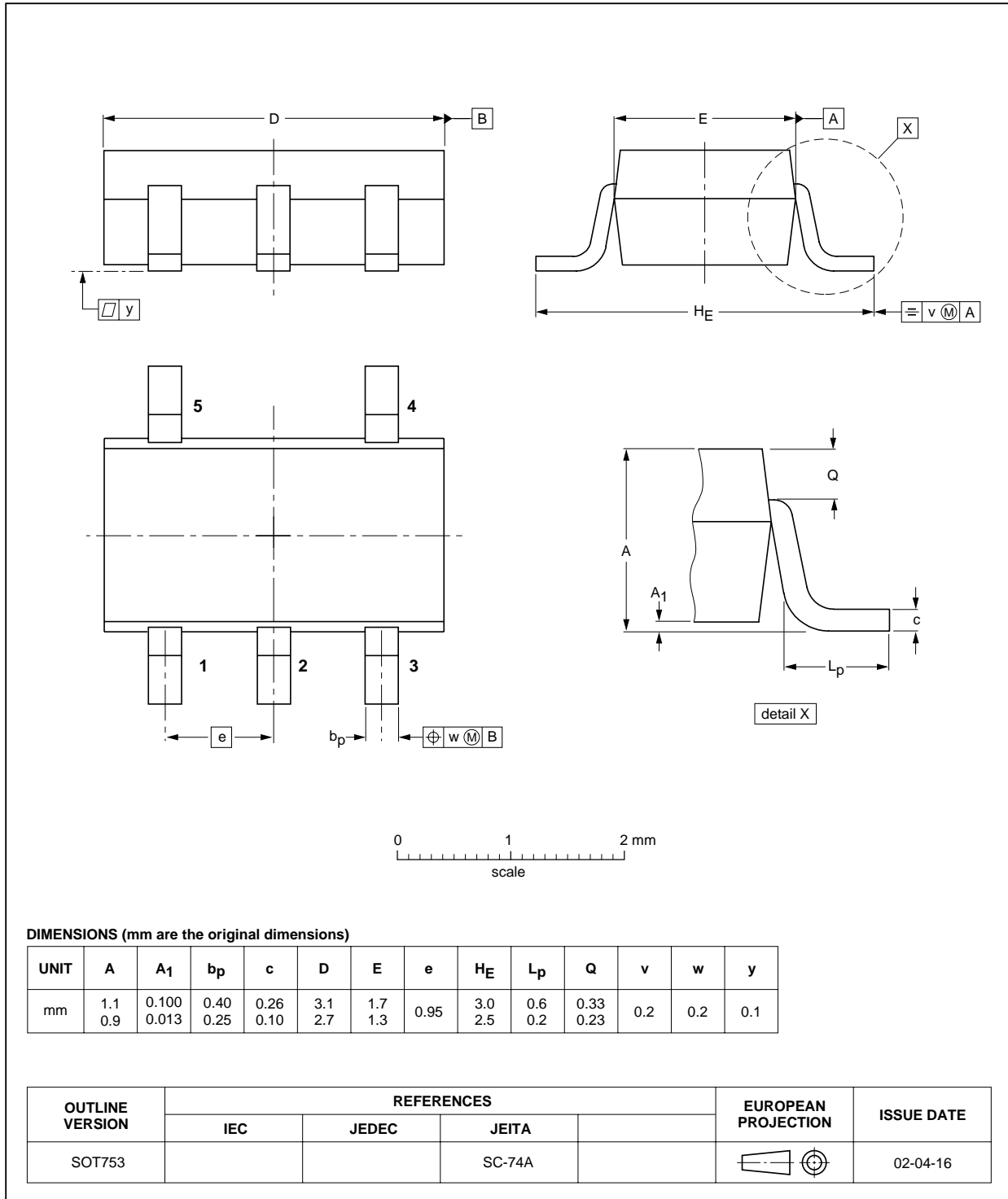

Inverter

74AHC1G04; 74AHCT1G04

DATA SHEET STATUS

LEVEL	DATA SHEET STATUS ⁽¹⁾	PRODUCT STATUS ⁽²⁾⁽³⁾	DEFINITION
I	Objective data	Development	This data sheet contains data from the objective specification for product development. Philips Semiconductors reserves the right to change the specification in any manner without notice.
II	Preliminary data	Qualification	This data sheet contains data from the preliminary specification. Supplementary data will be published at a later date. Philips Semiconductors reserves the right to change the specification without notice, in order to improve the design and supply the best possible product.
III	Product data	Production	This data sheet contains data from the product specification. Philips Semiconductors reserves the right to make changes at any time in order to improve the design, manufacturing and supply. Relevant changes will be communicated via a Customer Product/Process Change Notification (CPCN).

Notes

1. Please consult the most recently issued data sheet before initiating or completing a design.
2. The product status of the device(s) described in this data sheet may have changed since this data sheet was published. The latest information is available on the Internet at URL <http://www.semiconductors.philips.com>.
3. For data sheets describing multiple type numbers, the highest-level product status determines the data sheet status.

DEFINITIONS

Short-form specification — The data in a short-form specification is extracted from a full data sheet with the same type number and title. For detailed information see the relevant data sheet or data handbook.

Limiting values definition — Limiting values given are in accordance with the Absolute Maximum Rating System (IEC 60134). Stress above one or more of the limiting values may cause permanent damage to the device.

These are stress ratings only and operation of the device at these or at any other conditions above those given in the Characteristics sections of the specification is not implied. Exposure to limiting values for extended periods may affect device reliability.

Application information — Applications that are described herein for any of these products are for illustrative purposes only. Philips Semiconductors make no representation or warranty that such applications will be suitable for the specified use without further testing or modification.

DISCLAIMERS

Life support applications — These products are not designed for use in life support appliances, devices, or systems where malfunction of these products can reasonably be expected to result in personal injury. Philips Semiconductors customers using or selling these products for use in such applications do so at their own risk and agree to fully indemnify Philips Semiconductors for any damages resulting from such application.

Right to make changes — Philips Semiconductors reserves the right to make changes in the products - including circuits, standard cells, and/or software - described or contained herein in order to improve design and/or performance. When the product is in full production (status 'Production'), relevant changes will be communicated via a Customer Product/Process Change Notification (CPCN). Philips Semiconductors assumes no responsibility or liability for the use of any of these products, conveys no licence or title under any patent, copyright, or mask work right to these products, and makes no representations or warranties that these products are free from patent, copyright, or mask work right infringement, unless otherwise specified.

Philips Semiconductors – a worldwide company

Contact information

For additional information please visit <http://www.semiconductors.philips.com>. Fax: **+31 40 27 24825**

For sales offices addresses send e-mail to: sales.addresses@www.semiconductors.philips.com.

© Koninklijke Philips Electronics N.V. 2003

SCA75

All rights are reserved. Reproduction in whole or in part is prohibited without the prior written consent of the copyright owner.

The information presented in this document does not form part of any quotation or contract, is believed to be accurate and reliable and may be changed without notice. No liability will be accepted by the publisher for any consequence of its use. Publication thereof does not convey nor imply any license under patent- or other industrial or intellectual property rights.

Printed in The Netherlands

R44/06/pp16

Date of release: 2003 Sep 04

Document order number: 9397 750 11919

Let's make things better.

**Philips
Semiconductors**



PHILIPS