

## PC Card (PCMCIA) Interface Switch

### FEATURES

- Single SO-8 Package
- CMOS-Logic Compatible Inputs
- Slow  $V_{CC}$  Ramp Time
- Smart Switching
- Extremely Low  $R_{ON}$
- Reverse Blocking Switches
- Low Power Consumption
- Safe Power Up

### DESCRIPTION

The Si9706DY offers an integrated solution for PC Card power interfaces that only require  $V_{CC}$  switching. This part is ideal for systems that operate at 5 V and provide  $V_{PP}$  from the main supply or from a dedicated Flash RAM 12-V supply.

The Si9706DY operates off the 5-V supply and has built-in level shifting for gate drive. Internal logic protects against a control logic error that would short 5 V to the 3.3-V supply. This protection logic also allows the Si9706DY to be configured for

positive or negative control logic for compatibility with a variety of PC Card controllers. These control inputs are CMOS logic compatible and can be driven to 3.3 V or 5 V.

The Si9706DY PC Card interface switch is packaged in a narrow body SO-8 package and is rated over the industrial temperature range  $-40$  to  $85^{\circ}\text{C}$ . The Si9706DY is available in lead free.

### FUNCTIONAL BLOCK DIAGRAM

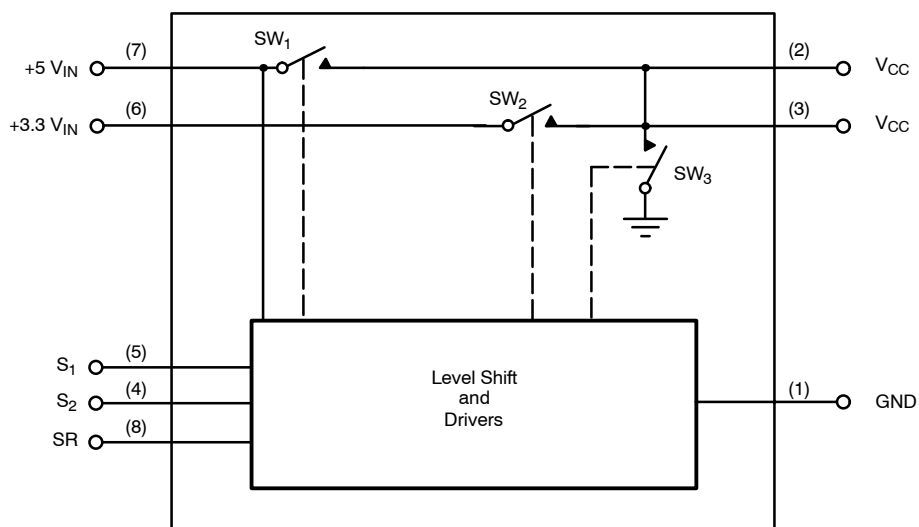



### ABSOLUTE MAXIMUM RATINGS

Voltages Referenced to Ground	
+5 V <sub>IN</sub> .....	7 V
+3.3 V <sub>IN</sub> .....	7 V
S <sub>1</sub> , S <sub>2</sub> (CMOS Inputs) .....	7 V
All Pins .....	-0.5 V
I <sub>OUT</sub> V <sub>CC</sub> <sup>a</sup> .....	4 A

PD Max <sup>b</sup> : (T <sub>A</sub> = 25°C) .....	1.59 W
(T <sub>A</sub> = 85°C) .....	0.63 W
Junction Temperature .....	125°C
Thermal Ratings <sup>b</sup> : R <sub>θJA</sub> .....	63 °C/W

#### Notes

- Pins 2, 3 connected together externally.
- Mounted on 1-IN<sup>2</sup>, FR4 PC Board.

### RECOMMENDED OPERATING CONDITIONS

+5 V <sub>IN</sub> (must be present) .....	5 V ± 10%
+3.3 V <sub>IN</sub> .....	3.3 V ± 10%
C <sub>SR</sub> .....	33 nF
I <sub>OUT</sub> V <sub>CC</sub> <sup>a</sup> .....	2 A

V <sub>CC</sub> Load Capacitance .....	150 μF Max
--	------------

#### Notes

- Pins 2, 3 connected together externally.

SPECIFICATIONS							
Parameter	Symbol	Test Conditions Unless Otherwise Specified C <sub>SR</sub> = 33 nF, +5 V <sub>IN</sub> = 5 V +3.3 V <sub>IN</sub> = 3.3 V, Low ≤ 0.8 V, High ≥ 2.2 V		Limits			Unit
				Min <sup>a</sup>	Typ <sup>b</sup>	Max <sup>a</sup>	
<b>Switch SW<sub>1</sub></b>							
On-Resistance	R <sub>ON</sub>	I = 500 mA, S <sub>1</sub> = High S <sub>2</sub> = Low	T <sub>A</sub> = 25°C T <sub>A</sub> = 85°C	58 73	70 90		mΩ
Off Current (V <sub>CC</sub> )	I <sub>OFF</sub>	+5 V <sub>IN</sub> = 5.5 V, V <sub>CC</sub> = 0 V S <sub>1</sub> = S <sub>2</sub> = Low	T <sub>A</sub> = 25°C T <sub>A</sub> = 85°C		1 10		μA
Rise Time	t <sub>S1(on)</sub>	S <sub>2</sub> = Low, See Figure 1		0.2	1.7	5	ms
Fall Time	t <sub>S1(off)</sub>			10	30	50	
<b>Switch SW<sub>2</sub></b>							
On-Resistance	R <sub>ON</sub>	I = 500 mA, S <sub>2</sub> = High S <sub>1</sub> = Low	T <sub>A</sub> = 25°C T <sub>A</sub> = 85°C	44 55	55 70		mΩ
Off Current (+3.3 V <sub>IN</sub> )	I <sub>OFF</sub>	+3.3 V <sub>IN</sub> = 3.6 V, V <sub>CC</sub> = 0 V S <sub>1</sub> = S <sub>2</sub> = Low	T <sub>A</sub> = 25°C T <sub>A</sub> = 85°C		1 10		μA
Rise Time	t <sub>S2(on)</sub>	S <sub>1</sub> = Low, See Figure 1		0.1	0.9	5	ms
Fall Time	t <sub>S2(off)</sub>			5	20	40	
<b>Switch SW<sub>3</sub></b>							
On-Resistance	R <sub>ON</sub>	I = 2 mA, S <sub>1</sub> = S <sub>2</sub> = Low	T <sub>A</sub> = 25°C T <sub>A</sub> = 85°C	140 200	400 500		Ω
<b>Power Supply</b>							
+5 V <sub>IN</sub> Current Input (on)	I <sub>+5VIN(1)</sub>	S <sub>1</sub> = 0 V, S <sub>2</sub> = 3 V			20	50	μA
	I <sub>+5VIN(2)</sub>	S <sub>1</sub> = 3 V, S <sub>2</sub> = 0 V			20	50	
+5 V <sub>IN</sub> Current Input (off)	I <sub>+5VIN(3)</sub>	S <sub>1</sub> = S <sub>2</sub> = 0 V			< 1	10	
Input Voltage High	V <sub>I(H)</sub>	+5 V <sub>IN</sub> = 5.5 V +5 V <sub>IN</sub> = 4.5 V		2.2 2.2	1.8 1.6		V
Input Voltage Low	V <sub>I(L)</sub>	+5 V <sub>IN</sub> = 5.5 V +5 V <sub>IN</sub> = 4.5 V			1.6 1.4	0.8 0.8	
Input Current High	I <sub>I(H)</sub>	S <sub>1</sub> , S <sub>2</sub> = 5 V				1.0	μA
Input Current Low	I <sub>I(L)</sub>	S <sub>1</sub> , S <sub>2</sub> = GND		-1.0			

#### Notes

- The algebraic convention whereby the most negative value is a minimum and the most positive a maximum.
- Typical values are for DESIGN AID ONLY, not guaranteed nor subject to production testing.

### TIMING WAVEFORMS

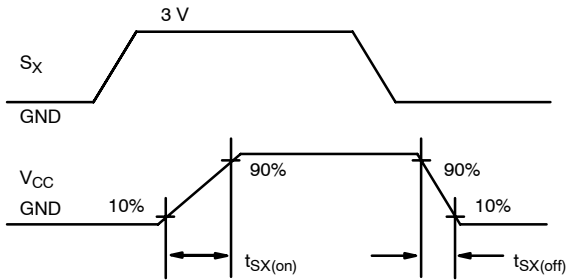

FIGURE 1. Switch Ramp

### TRUTH TABLE

S <sub>1</sub>	S <sub>2</sub>	Switch 1	Switch 2	Switch 3
0	0	Off	Off	On
0	1	Off	On	Off
1	0	On	Off	Off
1	1	Off	Off	On

Notes

- a. The smart switching of the Si9706DY avoids potential host damage by defaulting to off during error conditions.

### PIN CONFIGURATION AND DESCRIPTION

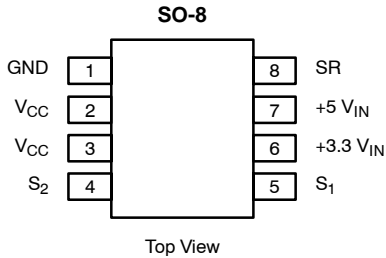

Pin	Function	Description
1	GND	Ground connection.
2, 3	V <sub>CC</sub>	Supply voltage to slot.
4	S <sub>2</sub>	Control input for selecting +3.3 V <sub>IN</sub> to V <sub>CC</sub> .
5	S <sub>1</sub>	Control input for selecting +5 V <sub>IN</sub> to V <sub>CC</sub> .
6	+3.3 V <sub>IN</sub>	+3.3-V supply.
7	+5 V <sub>IN</sub>	+5-V supply.
8	SR	Slew rate control pin.

### ORDERING INFORMATION

Part Number	Temperature Range
Si9706DY-T1	-40 to 85 °C
Si9706DY-T1-E3 (Lead Free)	

### TYPICAL CHARACTERISTICS (25 °C UNLESS OTHERWISE NOTED)

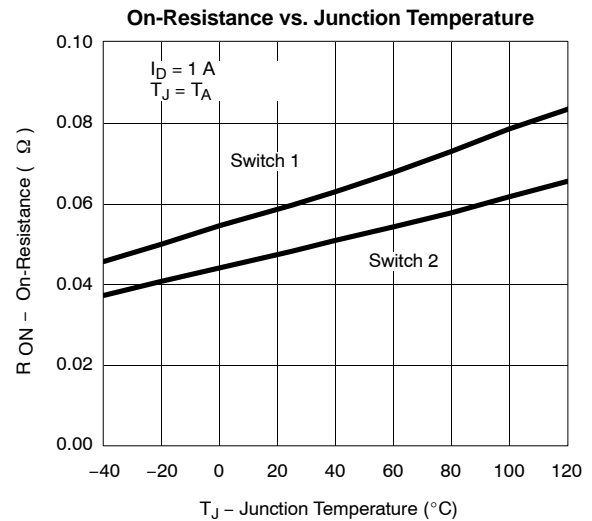
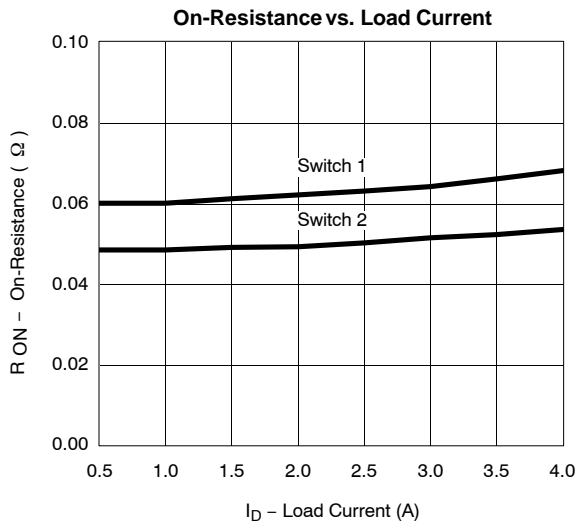

**TYPICAL CHARACTERISTICS (25 °C UNLESS OTHERWISE NOTED)**

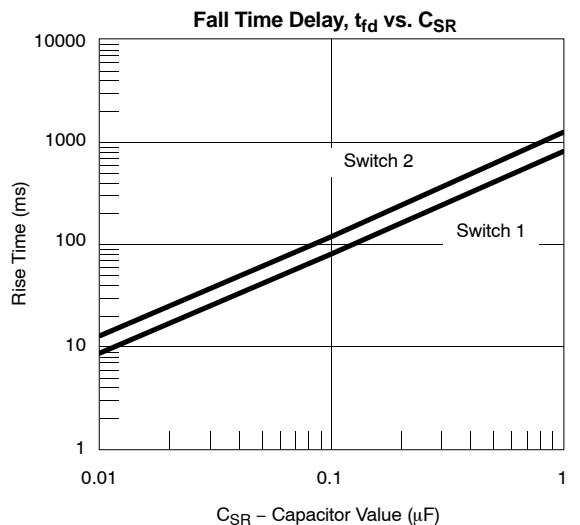
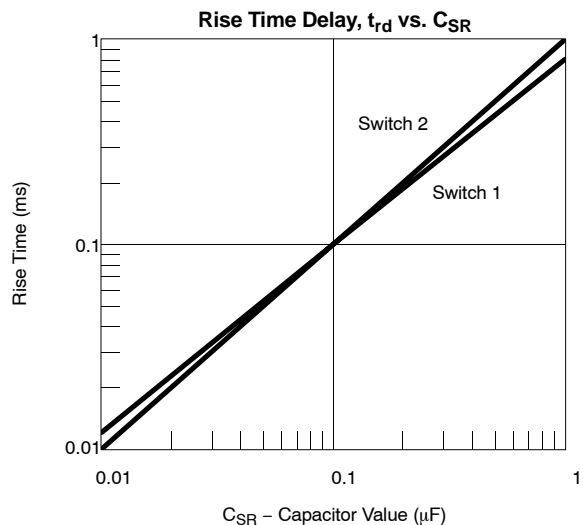
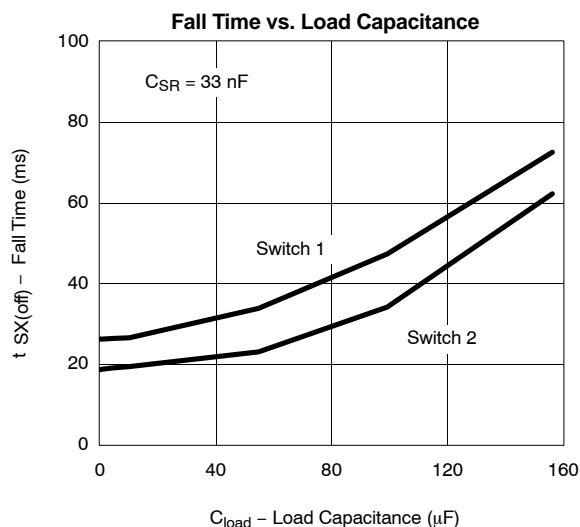
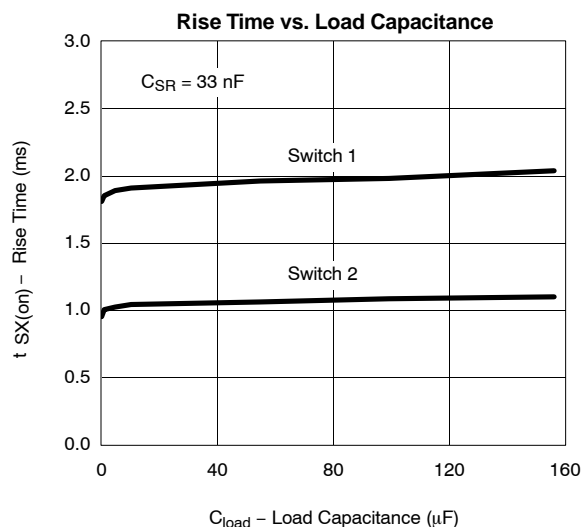
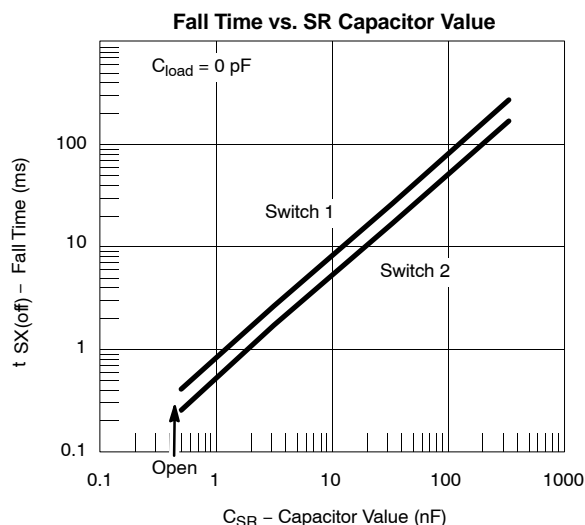
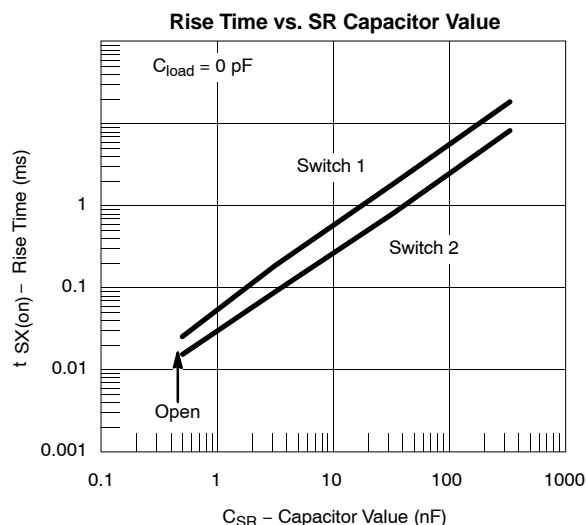



## Disclaimer

All product specifications and data are subject to change without notice.

Vishay Intertechnology, Inc., its affiliates, agents, and employees, and all persons acting on its or their behalf (collectively, "Vishay"), disclaim any and all liability for any errors, inaccuracies or incompleteness contained herein or in any other disclosure relating to any product.

Vishay disclaims any and all liability arising out of the use or application of any product described herein or of any information provided herein to the maximum extent permitted by law. The product specifications do not expand or otherwise modify Vishay's terms and conditions of purchase, including but not limited to the warranty expressed therein, which apply to these products.

No license, express or implied, by estoppel or otherwise, to any intellectual property rights is granted by this document or by any conduct of Vishay.

The products shown herein are not designed for use in medical, life-saving, or life-sustaining applications unless otherwise expressly indicated. Customers using or selling Vishay products not expressly indicated for use in such applications do so entirely at their own risk and agree to fully indemnify Vishay for any damages arising or resulting from such use or sale. Please contact authorized Vishay personnel to obtain written terms and conditions regarding products designed for such applications.

Product names and markings noted herein may be trademarks of their respective owners.