



### FEATURES

#### Low Cost

**Versatility: Adjustable Threshold, Gain & Output Offset**

**Guaranteed Low Nonlinearity: 80ppm Max, 451L and 453L**

**Accepts TTL, CMOS, HNIL, Sinewave, Pulse, Squarewave and Triangle Wave Input Signals**

**No External Components to Meet Rated Performance**

**+20mA Output to Operate Relays and Meters**

**Low Profile Package, 0.4" Case Height**

**Meet MIL-STD-202E Environmental Testing**

### APPLICATIONS

**Motor Control and Speed Monitor**

**Line Frequency Monitor and Alarm Indicator**

**Fluid Flow Measurements and Control**

**FM Demodulation and VCO Stabilization**

**Frequency vs. Amplitude Response Measurements**

### GENERAL DESCRIPTION

Models 451 and 453 are low cost 10kHz and 100kHz frequency to voltage converters that feature excellent low nonlinearity to less than 80ppm, output current of +20mA and the capability of interfacing with TTL, HNIL, CMOS, sinewave, squarewave, pulse and triangular input signals. External components are not required to achieve rated performance, however, extreme versatility is maintained by allowing access to all critical points of the design. This versatility allows programmable input threshold, gain, and output offset voltage.

Both models 451 and 453 are available in three selections, each offering guaranteed maximum nonlinearity error as well as maximum gain drift error. Models 451J and 453J offer 0.03% max nonlinearity and 100ppm/°C max gain drift. Models 451K and 453K offer 0.015% max nonlinearity and 50ppm/°C max gain drift. Models 451L and 453L offer 0.008% max nonlinearity and 50ppm/°C max gain drift.

### WHERE TO USE FREQUENCY TO VOLTAGE CONVERTERS

Pin compatible with existing popular models, these versatile new designs offer economical solutions to a wide variety of applications where it is required to convert frequency to an analog voltage.

**Process Control Systems:** For motor speed controllers, power line frequency monitoring and fluid flow measurements where flow transducers, such as variable reluctance magnetic pickups, provide pulse train outputs as a linear function of flow rate.

**Audio and Accoustic Systems:** For wow and flutter measurements with tape recorders and turntables, FM demodulation and speaker response measurements.

**Test Instrumentation:** For VCO stabilization, analog readout frequency meter, vibrational analysis and frequency versus amplitude X-Y plots where the vertical axis presents the nor-

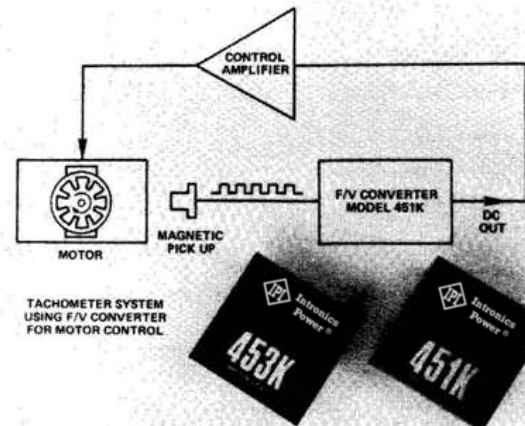

mal amplitude signal and the horizontal axis presents the output signal from the F/V converter.

**Data Acquisition Systems:** For converting serially transmitted data back to analog voltages.

### DESIGN FEATURES AND USER BENEFITS

The combination of low cost and high performance provided by models 451 and 453 offers exceptional quality and value to the OEM designer. These compact modules have been designed to provide maximum versatility, thereby increasing their utility in a broad scope of applications.

**Adjustable Input Threshold:** Threshold level is externally resistor programmable from 0 to ±12V, permitting simple, direct interface with low level signals, e.g. 10mV p-p, as well as with high level inputs such as CMOS and HNIL logic levels, e.g. 0 to +12V.

**Adjustable Gain:** Model 451 can be adjusted to provide full scale output voltage for any input frequency from 100Hz to 20kHz. Model 453 can be adjusted to provide full scale output voltage for any input frequency from 1kHz to 200kHz. This adjustable gain feature enables the user to easily match the maximum frequency output from a wide class of frequency transducers to the +10V full scale output from models 451 and 453. Increased signal conversion sensitivity with higher resolution results.

**Adjustable Output Offset Voltage:** The output offset is adjustable from -10V to +10V, enabling bipolar outputs or expanded scale measurements or setting the input frequency where zero output voltage occurs.

# SPECIFICATIONS (typical @ +25°C and $V_S = \pm 15V$ dc unless otherwise noted)

MODEL	10kHz FULL SCALE			100kHz FULL SCALE		
	J	451 K	L	J	453 K	L
TRANSFER FUNCTION	$E_O = (10^{-3} V/Hz)(F_{IN})$			$E_O = (10^{-4} V/Hz)(F_{IN})$		
FREQUENCY INPUT						
Frequency Range	dc to 10kHz min			dc to 100kHz min		
Overrange	10% min			10% min		
Waveforms	Sine, Square, Triangle, Pulse Train			Sine, Square, Triangle, Pulse Train		
Pulse Width (Pulse Train Input)	20 $\mu$ s min			2 $\mu$ s min		
Threshold	+1.4V			+1.4V		
With External Adjustment	0V to $\pm 12V$			0V to $\pm 12V$		
Hysteresis	$\pm 50mV$			$\pm 100mV$		
Levels (TTL Compatible)	High	+1.45V to +12V		High	+1.5V to +12V	
	Low	-12V to +1.35V		Low	-12V to +1.3V	
Max Safe Input Voltage <sup>1</sup>	$\pm V_S$			$\pm V_S$		
Impedance	10M $\Omega$    10pF			10M $\Omega$    10pF		
ACCURACY						
Warm-Up Time	one minute			one minute		
Nonlinearity <sup>2</sup>						
$F_{IN} = 1Hz$ to 11kHz	$\pm 0.03\%$ max	$\pm 0.015\%$ max	$\pm 0.008\%$ max	$\pm 0.03\%$ max	$\pm 0.015\%$ max	$\pm 0.008\%$ max
$F_{IN} = 1Hz$ to 110kHz	—	—	—	—	—	—
Gain vs. Temperature <sup>3</sup> (0 to +70°C)	$\pm 100ppm/^{\circ}C$ max	$\pm 50ppm/^{\circ}C$ max	$\pm 50ppm/^{\circ}C$ max	$\pm 100ppm/^{\circ}C$ max	$\pm 50ppm/^{\circ}C$ max	$\pm 50ppm/^{\circ}C$ max
vs. Supply Voltage	$\pm 30ppm/\%$			$\pm 35ppm/\%$		
vs. Time	$\pm 30ppm/month$			$\pm 30ppm/month$		
RESPONSE						
Step Response to $\pm 0.5\%$ of Final Value						
$F_{IN} = dc$ to Full Scale	4ms			0.8ms		
$F_{IN} = Full Scale$ to dc	30ms			4ms		
Internal Filter Time Constant	200 $\mu$ s			24 $\mu$ s		
External Filter Time Constant	20ms/ $\mu$ F			20ms/ $\mu$ F		
OUTPUT <sup>4</sup>						
Voltage ( $F_{IN} = Full Scale$ ) <sup>5</sup>	+9.85V min; +9.95V max			+9.85V min; +9.95V max		
Current ( $E_O = +10V, -10V$ )	(+20, -2)mA min			(+20, -2)mA min		
Offset Voltage <sup>6</sup> @ +25°C	$\pm 7.5mV$ max			$\pm 7.5mV$ max		
vs. Temperature (0 to +70°C)	$\pm 30\mu V/^{\circ}C$ max			$\pm 30\mu V/^{\circ}C$ max		
vs. Supply Voltage	$\pm 100\mu V/\%$ max			$\pm 50\mu V/\%$ max		
vs. Time	$\pm 100\mu V/month$			$\pm 100\mu V/month$		
Ripple						
$F_{IN} = 1Hz$	3mV p-p			55mV p-p		
$F_{IN} = 10kHz$	80mV rms			35mV rms		
$F_{IN} = 100kHz$	—			35mV rms		
Impedance	0.1 $\Omega$			0.1 $\Omega$		
Offset Scale Factor <sup>7</sup>	-56 $\mu A/V$			-45 $\mu A/V$		
POWER SUPPLY <sup>8</sup>						
Voltage, Rated Performance	$\pm 15V$ dc			$\pm 15V$ dc		
Voltage, Operating	$\pm (12$ to $18)V$ dc			$\pm (12$ to $18)V$ dc		
Current, Quiescent	(+10, -8)mA			(+10, -8)mA		
TEMPERATURE RANGE						
Rated Performance	0 to +70°C			0 to +70°C		
Operating	-25°C to +85°C			-25°C to +85°C		
Storage	-55°C to +85°C			-55°C to +125°C		
MECHANICAL						
Case Size	1.5" x 1.5" x 0.4"			1.5" x 1.5" x 0.4"		
Weight	25 grams			25 grams		

## NOTES

- <sup>1</sup>  $F_{IN}$  and REF terminals can be shorted to  $\pm V_S$  indefinitely without damage.
- <sup>2</sup> Nonlinearity error is specified as a percentage of 10V full scale output level.
- <sup>3</sup> Gain temperature drift is specified in ppm of output signal level.
- <sup>4</sup> OUT terminal can be shorted indefinitely to  $\pm V_S$  and ground without damage.
- <sup>5</sup> Adjustable to +10.000V using FULL SCALE ADJUST trim pot.

- <sup>6</sup> Adjustable to zero using 50k $\Omega$  OFFSET ADJUST trim pot.
  - <sup>7</sup> Current into the SUM PT terminal to offset the output voltage positive.
  - <sup>8</sup> Recommended power supply, AD1 model 904,  $\pm 15V$  @ 50mA output.
- Specifications subject to change without notice.

All Units Meet the Requirements of  
MIL-STD-202E as Outlined Below

TEST	METHOD	CONDITION
High Temperature Storage	108A	D (Non-Operating)
Moisture Resistance	106D	(10 Days)
Solderability	208C	
Thermal Shock	107D	A (5 Cycles)
Terminal Strength	211A	A (Pull Test; 10 lbs)
Temperature Cycling	102A	D (-55°C/+85°C)
Vibration	204C	B (15g Peak)
Barometric Pressure	105C	B (50,000 Feet)

Table I. Environmental Specifications

## OUTLINE DIMENSIONS

Dimensions shown in inches and (mm)

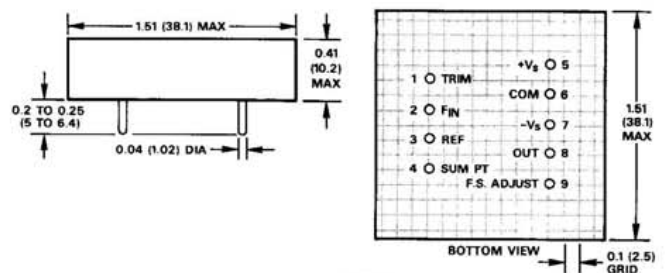

WEIGHT: 25 grams

MATING SOCKET: AC1060



# Applying the Frequency-to-Voltage Converter

## FREQUENCY TO VOLTAGE OPERATION

Models 451 and 453 accept virtually any signal waveshape providing accurate conversion into an output voltage proportional to the input signal frequency. The only restriction is that the input signal must remain above the threshold level for 20 $\mu$ s when using model 451, and 2 $\mu$ s when using model 453. Linear, stable conversion over four decades of input range for model 451 and five decades of input range for model 453, is achieved using a precision charge-dispensing design approach. Figure 1 represents a functional block diagram for both models 451 and 453 frequency to voltage converters.

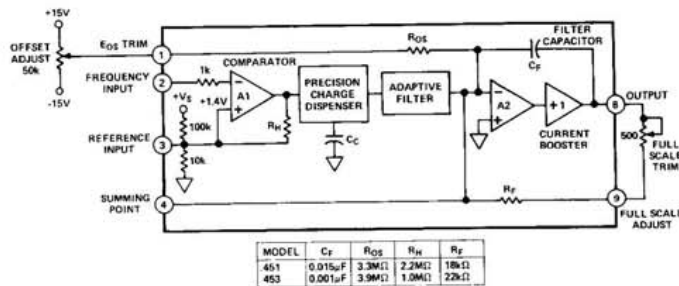

Figure 1. Block Diagram – Models 451 & 453 F/V Converters

## THEORY OF OPERATION

Input signals are applied directly to a comparator, A1, which is internally set to provide a +1.4V threshold with  $\pm 50$ mV hysteresis for model 451 and  $\pm 100$ mV hysteresis for model 453. This threshold level offers excellent noise immunity for TTL input levels. Following the input comparator is a precision charge dispensing circuit and output amplifier where the comparator signal is converted to a dc voltage. When the input comparator changes state, C<sub>C</sub> is alternately charged from a precision voltage reference and discharged through the summing point of an output amplifier, A2. A fixed amount of charge, Q, is controlled during each charge/discharge cycle. The higher the input frequency, the higher the average current into the summing point of A2. A current to voltage conversion is then accomplished by R<sub>F</sub>. The current pulses from the charge dispensing circuit are integrated by C<sub>F</sub> to reduce ripple. Added filtering for low frequency input signals is provided by an adaptive filter at the output of the charge dispensing circuit.

## BASIC F/V HOOK-UP

Models 451 and 453 can be applied directly to achieve rated performance without external trim potentiometers or other components. Figure 2 illustrates the basic wiring connection for either F/V converter model. Using the basic hookup as shown, full scale output voltage accuracy is +10V, -1/2% to -1 1/2%. The output offset voltage is 0V to  $\pm 7.5$ mV. The Full Scale and Output Offset errors can be eliminated by using the FINE TRIM PROCEDURE.

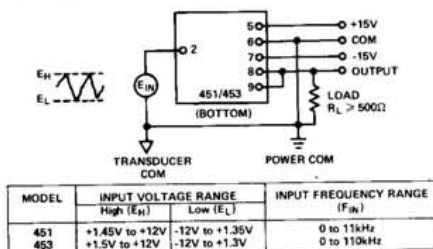

Figure 2. Basic Wiring Interconnection

## FINE TRIM PROCEDURE

Connect the F/V converter as shown in Figure 3 and allow a five minute warm-up after initial power turn-on. Adjust the OFFSET ADJUST pot, R<sub>O</sub>, for an output of 0.000V. The input terminal, F<sub>IN</sub>, can be left open or tied to COM without affecting OFFSET ADJUST. Using a precision, stable frequency source connected to F<sub>IN</sub> terminal, set the input frequency to 10.000kHz for model 451 or 100.000kHz for model 453. Adjust the FULL SCALE ADJUST trim pot, R<sub>S</sub>, for an output of +10.000V.

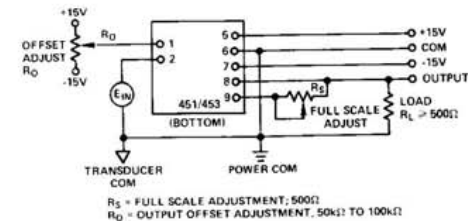

Figure 3. Wiring Interconnection Showing Fine Adjustment Trims for Offset and Full Scale Frequency

## ADDITIONAL TRIM CAPABILITY

**Adjusting Input Threshold:** The input comparator of models 451 and 453 shown in Figure 1, conditions the input signals providing protection against noisy environments as well as preventing double triggering with slow rise-time signals. Input levels up to the supply voltages,  $\pm V_S$ , will not cause damage to the input comparator.

Threshold voltage level, V<sub>T</sub>, is internally set for both models 451 and 453 at +1.4V. Hysteresis, V<sub>H</sub>, for model 451 is  $\pm 50$ mV, and  $\pm 100$ mV for model 453. Signals of virtually any waveshape which exceed the combined threshold and hysteresis levels, V<sub>T</sub>  $\pm$  V<sub>H</sub>, will trigger the F/V converter. The REF terminal permits the user to conveniently adjust the input threshold over the range from 0 to  $\pm 12$ V to achieve optimum noise rejection or increased triggering sensitivity.

**Increasing Threshold for Greater Noise Immunity:** Connecting an external resistor from the REF terminal to the positive supply voltage, +V<sub>S</sub>, increases the input threshold level above +1.4V, offering increased input noise immunity. Optimum noise immunity is generally determined by adjusting the threshold level to a point mid-way between the high and low input signal levels. For example, for a 0 to +12V input swing – representative of CMOS and HNIL logic signals – a 17.6k $\Omega$  resistor from +15V to the REF terminal results in a +6V threshold.

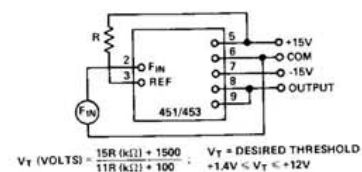

Figure 4. Increasing Threshold Above +1.4V for Greater Noise Immunity

Changes in impedance at the REF terminal result in changes to the hysteresis. Hysteresis levels can be calculated by assuming the comparator output is switching between  $\pm 12$ V. This  $\pm 12$ V signal is attenuated by a resistor-divider network formed by



$R_H$  (see Figure 1) and the parallel combination of all resistors attached at the comparator positive input. For example, with a  $17.6k\Omega$  resistor connected to the REF terminal, hysteresis becomes  $\pm 35mV$  for model 451 and  $\pm 75mV$  for model 453. The F/V converter will, therefore, trigger at  $+6V \pm 35mV$  for model 451 and  $+6V \pm 75mV$  for model 453.

**Decreasing Threshold for Signals Less Than +1.4V:** A resistor connected from the REF terminal to the negative power supply,  $-V_S$ , will increase the input triggering sensitivity for operation with signals below  $+1.4V_{PK}$ . As shown in Figure 5, a minimum threshold of zero volts is obtained with a  $100k\Omega$  resistor. The triggering level,  $V_T \pm V_H$ , will be established by the resulting hysteresis levels. With a  $100k\Omega$  to  $-15V$ , model 451 hysteresis will be  $\pm 50mV$  and model 453 hysteresis will be  $\pm 60mV$ .

To reduce the hysteresis for greater triggering sensitivity, a  $1k\Omega$  resistor can be connected from the REF terminal to COM. Signals exceeding  $\pm 5mV$  ( $10mV$  p-p) with model 451 and  $\pm 15mV$  ( $30mV$  p-p) for model 453, will operate the F/V converter. A  $1k\Omega$  resistor from REF to COM is the minimum value recommended to reduce hysteresis and achieve reliable operation.

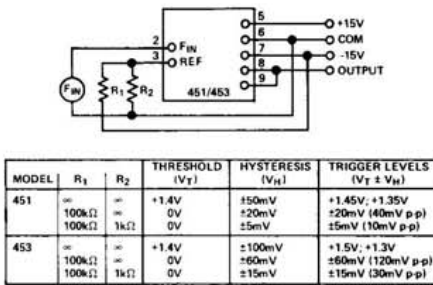

Figure 5. Decreasing Threshold Below +1.4V to Increase Triggering Sensitivity for Low Level Input Signals

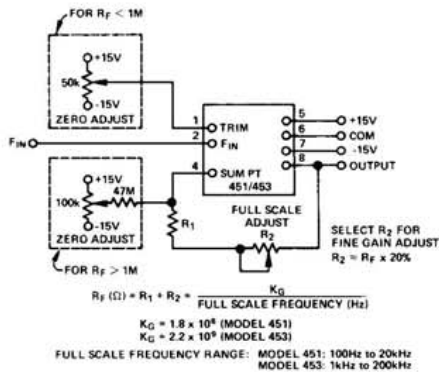

Figure 6. Selecting External Gain Resistor  $R_F$

**Adjusting Gain:** Connect the FULL SCALE ADJUST terminal to the OUTPUT terminal to set the gain of model 451 at  $10^{-3}V/Hz$  for a 10kHz full scale input frequency and the gain of model 453 at  $10^{-4}V/Hz$  for a 100kHz full scale input frequency. Connecting an external resistor from the SUM PT terminal to the OUTPUT terminal and leaving the FULL SCALE ADJUST terminal open, facilitates gain adjustment. Model 451 can be adjusted over the range from  $10^{-1}V/Hz$  to  $5 \times 10^{-4}V/Hz$  resulting in a full scale input frequency from 100Hz to 20kHz respectively. The gain of model 453 can be adjusted over the range from  $10^{-2}V/Hz$  to  $5 \times 10^{-5}V/Hz$  resulting in a full scale input frequency from 1kHz to 200kHz respectively. The gain

adjustment procedure is capable of increasing full scale frequency beyond the rated ranges for each model, however, nonlinearity will increase above 300ppm.

When using large values of  $R_F$  to externally set gain of the F/V converter, the output amplifier gain increases resulting in an increase in sensitivity when using the OFFSET ADJUST trim pot. For improved resolution in high gain applications ( $R_F > 1M\Omega$ ), an alternate method of trimming offset is shown in Figure 6.

**Offsetting the Output:** The output of models 451 and 453 can be offset over the range from  $-10V$  to  $+10V$ , enabling scale expansion for increased signal sensitivity as well as bipolar output swings up to 20V p-p.

Current introduced at the SUM PT terminal results in shifts of the output voltage directly proportional to the Offset Scale Factor,  $K_S$ . For model 451,  $K_S = -56\mu A/V$  and for model 453,  $K_S = -45\mu A/V$ . The offset current can be generated using an external resistor from a voltage reference to the SUM PT terminal. A stable, well regulated supply voltage, such as ADI's model 904 is recommended. To shift the output positive, 0 to  $+10V$ , connect the current resistor to the negative,  $-V_S$  supply. To shift the output negative, 0 to  $-10V$ , connect the current resistor to the positive,  $+V_S$ , supply.

The example using model 451 illustrated in Figure 7 provides a 0 to  $+5V$  output change in response to a 5kHz to 10kHz input change. With this input, a bipolar output from  $-2.5V$  to  $+2.5V$  can be obtained by increasing the output voltage shift from  $-5V$ , ( $R_C = 53.6k\Omega$ ) to  $-7.5V$ , ( $R_C = 35.7k\Omega$ ).

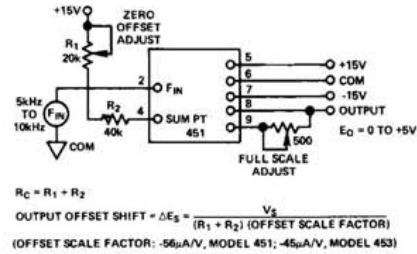

Figure 7. Selecting External Output Offset Resistor,  $R_C$

## SCALE EXPANSION

By combining both gain and output offset voltage adjustments, signals which exhibit a center frequency with small frequency changes, can be converted with improved resolution. Representative signals benefiting from the Scale Expansion procedure outlined below, are tachometer and frequency modulated signals. In the case of tachometer outputs, the speed is often set at an idle point and changes in output frequency represent changes in motor loading conditions. In the case of FM signals, the F/V converter can be applied such that the carrier frequency produces zero output. The resulting output voltage from the F/V converter represents the modulating signal.

**Procedure for Scale Expansion:** The following procedure incorporates both gain and output offset adjustments to achieve scale expansion. An example is illustrated in Figure 8 for an FM signal with a 50kHz carrier frequency and  $\pm 5kHz$  modulating signal.

- 1) Determine the Gain:  $G = \Delta E_O / \Delta F_{IN}$  where  $\Delta E_O$  is the total output voltage change desired in volts, and  $\Delta F_{IN}$  is the total input frequency change in Hz.
- 2) Calculate the external gain resistor,  $R_F$ :  
 $R_F (\Omega) = G(1.8 \times 10^7)$ , model 451  
 $R_F (\Omega) = G(2.2 \times 10^8)$ , model 453



# Understanding the Frequency-to-voltage Converter Performance

3) Calculate the Output Offset Shift,  $\Delta E_S$ , required to achieve the desired maximum output voltage,  $E_O$  (max) with the max input frequency,  $F_{IN}$  (max), and the new gain;

$$\Delta E_S \text{ (volts)} = G F_{IN} \text{ (max)} - E_O \text{ (max)}$$

4) Calculate the offset current resistor,  $R_C$ ;

$$R_C \text{ (}\Omega\text{)} = \frac{V_S G}{(\Delta E_S) (k_S)}$$

$$k_S = 56 \times 10^{-9}, \text{ model 451}$$

$$k_S = 45 \times 10^{-10}, \text{ model 453}$$

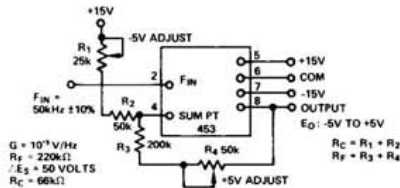

Figure 8. Application of Model 453 in FM Demodulation

## INTERFACING SIGNALS WITH DC OFFSETS > 10V

Signals with dc levels up to  $\pm 10V$  can be directly connected to the input terminal of models 451 and 453. Capacitive coupling, as shown in Figures 9 and 10, is used for inputs with dc offsets greater than  $\pm 10V$ . The  $1M\Omega$  resistor illustrated in Figure 9 provides a dc return path to power common for the input comparator bias current. Threshold adjustments can be made following the capacitor, to set the F/V input sensitivity to match the ac signal peak-to-peak amplitude. Signals as low as 10mV p-p with model 451 and 30mV p-p model 453 are acceptable. Refer to Figures 4 and 5.

AC signals greater than  $\pm V_S$  should be attenuated with a resistive divider network following the capacitor. When large input transients ( $> \pm V_S$ ) are possible due to either a noisy environment or power turn-on surges, protection is provided with the addition of two diodes as shown in Figure 10.

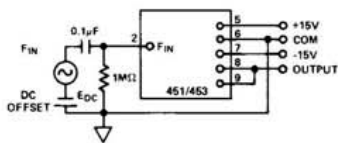

Figure 9. Interfacing Signals With DC Offsets Greater Than  $\pm 10V$

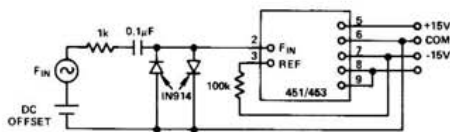

Figure 10. Input Diode Protection for High Voltage Transients

## PERFORMANCE SPECIFICATIONS

**Nonlinearity:** Nonlinearity error is specified as a % of 10V full scale output voltage and is guaranteed for each model over the specified input range. Model 451 is rated over 1Hz to 11kHz range and model 453 is rated over 1Hz to 110kHz range. Typical nonlinearity performance is shown for all models in Figure 11.

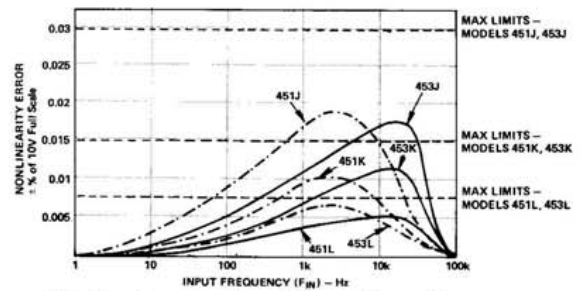

Figure 11. Nonlinearity Error Versus Input Frequency

**Gain Temperature Stability:** Gain Drift is specified in ppm of output signal and is guaranteed for each model over the 0 to  $+70^\circ C$  temperature range. Models 451K, 451L, 453K and 453L offer  $\pm 50\text{ppm}/^\circ C$  maximum gain drift. Models 451J and 453J offer  $\pm 100\text{ppm}/^\circ C$  maximum gain drift. Gain drift is typically half the guaranteed limits.

## OUTPUT RIPPLE

The output contains an ac ripple signal which increases in amplitude with input frequency. Adding external capacitance in parallel with the internal filter capacitor will reduce output ripple as shown in Figures 12 and 13.

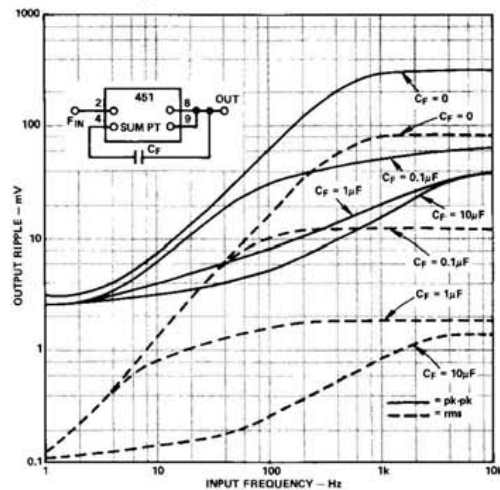

Figure 12. Output Ripple Versus External Filter Capacitor ( $C_f$ ) - Model 451

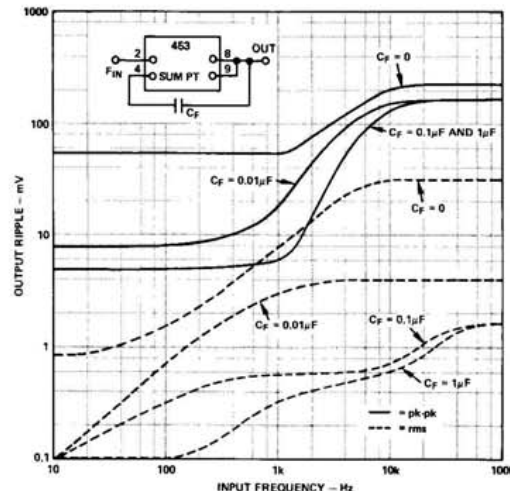

Figure 13. Output Ripple Versus External Filter Capacitor ( $C_f$ ) - Model 453



## SETTLING TIME

Increasing the external filter capacitor to reduce output ripple will increase the settling time to step changes in frequency occurring at the input. Figure 14 shows curves of settling time to  $\pm 0.5\%$  of final value for both increasing and decreasing full scale step changes. As  $C_F$  increases in value, the total filter time constants for models 451 and 453 approach equal values, resulting in identical settling time.

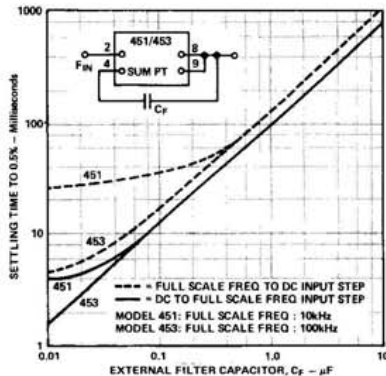

Figure 14. Settling Time Versus External Filter Capacitor

## APPLICATIONS IN PROCESS CONTROL SYSTEMS

### MOTOR CONTROLLER

In making rpm measurements, transducers are often encountered that have pulse-train outputs from variable-reluctance magnetic pickups (in which the output frequency is a function of rpm). These low level signals are generally in the range of 0 to 200mV peak. The adjustable input threshold feature of models 451 and 453 enables direct connection to low level transducers, offering simple, reliable interfacing.

The motor speed control and monitoring application shown in Figure 15 illustrates the F/V converter applied in a closed loop control system. R1 sets the threshold to +60mV with  $\pm 50$ mV hysteresis for model 451.

The +20mA output current capability of both models 451 and 453, enables direct interface to low impedance loads, up to 500 $\Omega$ , such as analog meters or relays.

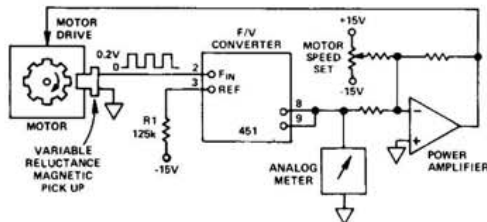

Figure 15. Application of F/V Converter to Control and Monitor Motor Speed in Closed Loop System

### SPEED SWITCH

With the addition of a low cost comparator and relay, the F/V converter provides a reliable approach to controlling heavy

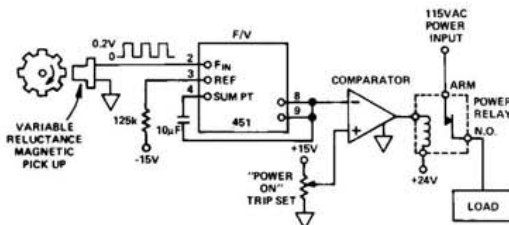

Figure 16. Application of F/V Converter to Control Load Power

generator loads after the generator has reached a specified speed. As shown in Figure 16, the relay will remain open until the output from the F/V converter reaches a preset POWER ON trip level. The F/V output signal is linearly related to the speed of the motor, permitting precise control of the POWER ON set point.

## APPLICATION IN INSTRUMENTATION SYSTEMS

### FREQUENCY MONITORING

Small input frequency changes can be monitored more readily by using the programmable gain feature of models 451 and 453 to achieve greater signal sensitivity. In the application of model 451 illustrated in Figure 17, gain has been set to 0.1V/Hz, resulting in a 100Hz full scale frequency range. The output resolution for small changes occurring in the 60Hz line frequency has been improved. An additional advantage of this approach is the reduced accuracy and stability requirements placed on the relay trip levels, set by the voltage levels at the comparators. A precision voltage reference supply is not required.

Since both models 451 and 453 tolerate input signals up to the supply levels,  $\pm V_S$ , costly input protection is eliminated in most applications.

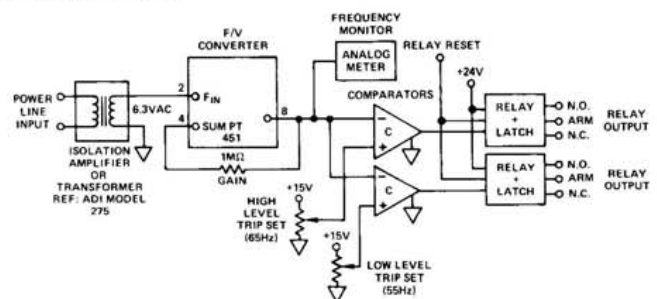

Figure 17. Application of F/V Converter to Monitor 60Hz Line Frequency

## APPLICATION IN DATA ACQUISITION SYSTEMS

### HIGH NOISE IMMUNITY TRANSMISSION

F/V converters are excellent companion products to V/F converters for use in low cost, two wire data transmission systems. As shown in Figure 18, this V/F/V approach utilizes the continuous self-locking feature of the V/F converter thereby eliminating the need for costly additional twisted pair cable for external synchronization. Model 610 instrumentation amplifier amplifies the low level differential transducer signal to the 10V full scale of models 450 and 456 10kHz V/F converters. A differential line driver is used to drive a twisted pair cable through a noisy environment. A differential line receiver is used to drive model 451 10kHz F/V converter. The low cost of the V/F and F/V converters in addition to the simple twisted pair cabling approach make it economical to use a V/F/V converter pair for each channel in a data acquisition system.

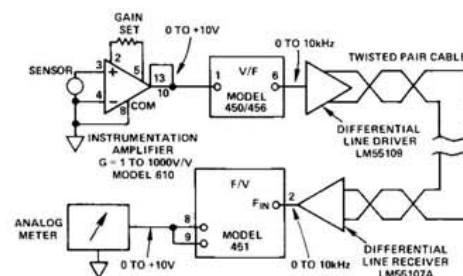

Figure 18. Application of F/V Converter in a Low Cost, High Noise Rejection Two-Wire Data Transmission System