

### FEATURES

- Wide sensor range: 50 *g* to 500 *g***
- Adjustable filter bandwidth: 100 Hz to 800 Hz**
- Configurable communication protocol**
  - 2-wire, current mode bus interface
- Selectable sensor data resolution: 8 bit or 10 bit**
- Continuous auto-zero**
- Fully differential sensor and interface circuitry**
  - High resistance to EMI/RFI
- Sensor self-test**
- 5.0 V to 14.5 V operation**
- 8 bits of user-defined OTP memory**
- 32-bit electronic serial number**
- Dual device per bus option**

### APPLICATIONS

- Crash sensing

### GENERAL DESCRIPTION

The ADXL180 *i*MEMS® accelerometer is a configurable, single axis, integrated satellite sensor that enables low cost solutions for front and side impact airbag applications. Acceleration data is sent to the control module via a digital 2-wire current loop interface bus. The communication protocol is programmable for compatibility with various automotive interface bus standards.

The sensor *g* range is configurable to provide full-scale ranges from  $\pm 50$  *g* to  $\pm 500$  *g*. The sensor signal third-order, low-pass Bessel filter bandwidth is configurable at 100 Hz, 200 Hz, 400 Hz, and 800 Hz.

The 10-bit analog-to-digital converter (ADC) allows either 8-bit or 10-bit acceleration data to be transmitted to the control module. Each part has a unique electronic serial number. The device is rated for operation from  $-40^{\circ}\text{C}$  to  $+125^{\circ}\text{C}$  and is available in a 5 mm  $\times$  5 mm LFCSP package.

### FUNCTIONAL BLOCK DIAGRAM

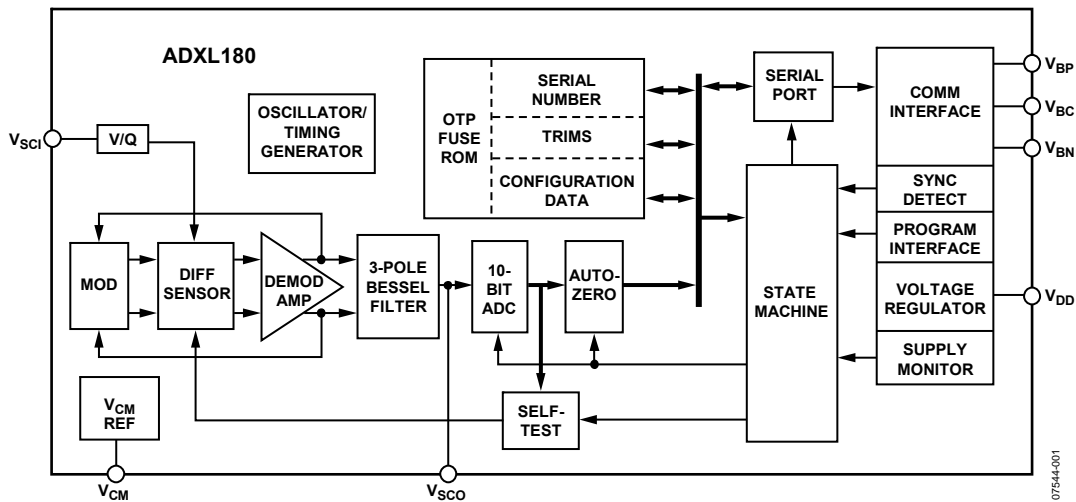

Figure 1.

#### Rev. A

Information furnished by Analog Devices is believed to be accurate and reliable. However, no responsibility is assumed by Analog Devices for its use, nor for any infringements of patents or other rights of third parties that may result from its use. Specifications subject to change without notice. No license is granted by implication or otherwise under any patent or patent rights of Analog Devices. Trademarks and registered trademarks are the property of their respective owners.

One Technology Way, P.O. Box 9106, Norwood, MA 02062-9106, U.S.A.  
Tel: 781.329.4700 [www.analog.com](http://www.analog.com)  
Fax: 781.461.3113 ©2008 Analog Devices, Inc. All rights reserved.

## TABLE OF CONTENTS

Features .....	1	Phase 2: Mode Description .....	30
Applications .....	1	Phase 3: Self-Test Diagnostic .....	37
General Description .....	1	Phase 4: Auto-Zero Initialization .....	40
Functional Block Diagram .....	1	Phase 5: Normal Operation .....	40
Revision History .....	3	Signal Range and Filtering .....	41
Specifications .....	4	Transfer Function Overview .....	41
Absolute Maximum Ratings .....	7	Range .....	41
ESD Caution .....	7	Three-Pole Bessel Filter .....	41
Pin Configuration and Function Descriptions .....	8	Auto-Zero Operation .....	41
Terminology .....	9	Error Detection .....	43
Theory of Operation .....	10	Overview .....	43
Overview .....	10	Parity Error Due to Communications Protocol Configuration Bit Error .....	43
Acceleration Sensor .....	10	Self-Test Error .....	44
Signal Processing .....	11	Offset Error/Offset Drift Monitoring .....	44
Digital Communications State Machine .....	11	Voltage Regulator Monitor Reset Operation .....	44
2-Wire Current Modulated Interface .....	11	Test and Diagnostic Tools .....	45
Synchronous Operation and Dual Device Bus .....	11	V <sub>SCI</sub> Signal Chain Input Test Pin .....	45
Programmed Memory and Configurability .....	11	V <sub>SCO</sub> Analog Signal Chain Output Test Pin .....	45
Physical Interface .....	13	Configuration Specification .....	46
Application Circuit .....	13	Overview .....	46
Current Modulation .....	13	Configuration Mode Transmit Communications Protocol ..	47
Manchester Data Encoding .....	14	Configuration Mode Command (Receive) Communications Protocol .....	48
Operation at Low V <sub>BP</sub> or Low V <sub>DD</sub> .....	14	Configuration Mode Communications Handshaking .....	49
Operation at High V <sub>DD</sub> .....	14	Configuration and User Data Registers .....	50
Communications Timing and Bus Topologies .....	15	Configuration Mode Exit .....	50
Data Transmission .....	15	Serial Number and Manufacturer Identification Data Registers .....	50
Asynchronous Communication .....	16	Programming the Configuration and User Data Registers ..	50
Synchronous Communication .....	17	OTP Programming Conditions and Considerations .....	51
Synchronous Communication Mode—Dual Device .....	19	Configuration/User Register OTP Parity .....	51
Data Frame Definition .....	23	Configuration Mode Error Reporting .....	51
Data Frame Transmission Format .....	23	Configuration Register Reference .....	52
Data Frame Configuration Options .....	23	UD[7:0] User Data Bits .....	53
Acceleration Data Coding .....	25	UD8 Configuration Bit .....	53
State Vector Coding .....	26	BDE .....	53
State Vector Descriptions .....	26	SCOE .....	53
Transmission Error Detection Options .....	27	FDLY .....	53
Application Layer: Communication Protocol State Machine ...	28	ADME .....	53
ADXL180 State Machine .....	28	STI .....	53
Phase 1: Power-on-Reset Initialization .....	28		
Phase 2: Device Data Transmission .....	28		

FC[1:0] .....	53	SVD .....	55
RG[2:0] .....	53	CUPAR and CUPRG .....	55
MD[1:0] .....	54	Axis of Sensitivity .....	56
SYEN .....	55	Branding .....	57
AZE .....	55	Outline Dimensions .....	58
ERC .....	55	Ordering Guide .....	58
DAT .....	55		

**REVISION HISTORY**

**11/08—Rev. 0 to Rev. A**

Added Data Transmission Section .....	15
Added New Figure 10, Renumbered Sequentially .....	15
Added New Figure 11 .....	16
Changes to Figure 14 .....	18
Changes to Figure 16 .....	20
Changes to Synchronization Pulse Detection Section .....	17

**8/08—Revision 0: Initial Version**

# ADXL180

## SPECIFICATIONS

$T_A = -40^{\circ}\text{C}$  to  $+125^{\circ}\text{C}$ ,  $V_{BP} - V_{BN} = 5.0\text{ V}$  to  $14.5\text{ V}$ ,  $f_{LP} = 400\text{ Hz}$ , acceleration =  $0\text{ g}$ , unless otherwise noted.

Table 1.

Parameter <sup>1</sup>	Symbol	Min	Typ	Max	Unit	Test Conditions/Comments
<b>SENSOR</b>						
Scale Factor						Measurement frequency: 100 Hz
50 g Range						See Table 37
8-Bit Data		0.465	0.50	0.535	g/LSB	
10-Bit Data		0.116	0.1250	0.134	g/LSB	
100 g Range						
8-Bit Data		0.930	1.00	1.070	g/LSB	
10-Bit Data		0.233	0.2500	0.268	g/LSB	
150 g Range						
8-Bit Data		1.395	1.50	1.605	g/LSB	
10-Bit Data		0.349	0.3750	0.401	g/LSB	
200 g Range						
8-Bit Data		1.860	2.00	2.140	g/LSB	
10-Bit Data		0.465	0.5000	0.535	g/LSB	
250 g Range						
8-Bit Data		2.325	2.50	2.675	g/LSB	
10-Bit Data		0.581	0.625	0.669	g/LSB	
350 g Range						
8-bit Data		3.255	3.50	3.745	g/LSB	
10-bit Data		0.830	0.8925	0.955	g/LSB	
500 g Range						
8-Bit Data		4.650	5.00	5.350	g/LSB	
10-Bit Data		1.163	1.2500	1.338	g/LSB	
Offset						All ranges, auto-zero disabled
8-Bit Data		-12		+11	LSB	
10-Bit Data		-48		+47	LSB	
Noise (Peak-to-Peak)						50 g range
8-Bit Data				2	LSB	10 Hz to 400 Hz
10-Bit Data			2	3	LSB	10 Hz to 400 Hz
Self Test						
Amplitude		20	25	30	g	
Internal Self-Test Limit		20		30	g	STI enabled, see Table 35
Nonlinearity			0.2	2	%	Of full-scale range
Cross-Axis Sensitivity		-5		+5	%	
Resonant Frequency			12.8		kHz	
Q			1.5			
<b>LOW-PASS FILTER</b>						
Frequency Response			Third-order Bessel			
Pass Band	$f_{LP}$					Programmable, see Table 38
-3 dB Frequency		670	800	880	Hz	
-3 dB Frequency		335	400	440	Hz	
-3 dB Frequency		167.5	200	220	Hz	
-3 dB Frequency		83.75	100	110	Hz	
<b>AUTO-ZERO</b>						
Update Rate						
Slow Mode			5.0		sec/LSB	10-bit LSB
Fast Mode			0.5		sec/LSB	10-bit LSB

Parameter <sup>1</sup>	Symbol	Min	Typ	Max	Unit	Test Conditions/Comments
<b>REGULATOR VOLTAGE MONITOR</b>						
Regulator Operating Voltage	V <sub>DD</sub>		4.20		V	
Power-Up Reset Voltage	V <sub>PUR</sub>	3.77	4.0	4.23	V	See Figure 33
Overvoltage Level	V <sub>OV</sub>	4.7	4.95	5.3	V	See Figure 33
Reset Hysteresis Voltage	V <sub>HYST</sub>		0.12		V	
<b>COMMUNICATIONS INTERFACE</b>						
Quiescent (Idle) Current	I <sub>IDLE</sub>	5	6	7.7	mA	
Modulation Current	I <sub>MOD</sub>	23	25	30	mA	
Signal Current	I <sub>SIG</sub>	28	31	37.7	mA	I <sub>SIG</sub> = I <sub>IDLE</sub> + I <sub>MOD</sub>
Autodelay Detect Current	I <sub>DET</sub>	18	22	26	mA	Total including I <sub>IDLE</sub>
Data Bit Period <sup>2</sup>	t <sub>B</sub>		8		μs	t <sub>B</sub> = 8 × t <sub>CLK</sub>
Data Bit Duty Cycle	D <sub>DC</sub>	45	50	53	%	D <sub>DC</sub> = t <sub>A</sub> /t <sub>B</sub> , see Figure 7
Data Bit Rise/Fall						See Figure 7
Fall Time	t <sub>R</sub>	400		1000	ns	
Rise Time	t <sub>F</sub>	350		1000	ns	
Encoding			Manchester			See Figure 8
ADC Conversion Time <sup>2</sup>	t <sub>ADC</sub>		35		μs	See Figure 12
Error Checking (Selectable)						
Number of CRC Bits			3			x <sup>3</sup> + x <sup>1</sup> + x <sup>0</sup>
Number of Parity Bits			1			Even
Synchronization Pulse Detect						
No Detect Limit	V <sub>SPND</sub>			3.0	V	
Detect Threshold	V <sub>SPT</sub>	3.5			V	V <sub>BP</sub> - V <sub>BN</sub> + V <sub>SPT</sub> ≤ 14.5 V; see Figure 14
Threshold Hysteresis			0.1		V	
Synchronization Pulse Detect Time	t <sub>SPD</sub>		8		t <sub>CLK</sub>	See Figure 14
Synchronization Pulse Discharge (Pull-Down) Time	t <sub>SPP</sub>		40		t <sub>CLK</sub>	See Figure 14
Synchronization Mode Transmission Delay	t <sub>STD</sub>		63		t <sub>CLK</sub>	See Figure 14
Configuration Mode Receive Communications Interface						All @ 25°C only; V <sub>BP</sub> - V <sub>BN</sub> + V <sub>CT</sub> ≤ 12.25 V
Detect Threshold	V <sub>CT</sub>	5.25			V	See Figure 35
Threshold Hysteresis			0.1		V	
Interbit Time	t <sub>IB</sub>	250			t <sub>CLK</sub>	See Figure 35
Data 0 Pulse Width	t <sub>PG0</sub>	40		55	t <sub>CLK</sub>	See Figure 35
Data 1 Pulse Width	t <sub>PG1</sub>	80			t <sub>CLK</sub>	See Figure 35
Configuration Mode Response Time	t <sub>TM1</sub>		24		μs	See Figure 35
Configuration Mode Write Delay Time	t <sub>TM2</sub>		50		μs	See Figure 35
V <sub>BP</sub> During Fuse Programming	V <sub>BPF</sub>	7.5			V	Compliant up to the maximum operating voltage
V <sub>BP</sub> Current During Fuse Programming	I <sub>FP</sub>			15	mA	Maximum drawn by the part

# ADXL180

Parameter <sup>1</sup>	Symbol	Min	Typ	Max	Unit	Test Conditions/Comments	
<b>ASYNCHRONOUS MODE TIMING<sup>2</sup></b>							
Message Transmission Period							
Phase 2, Mode 0	t <sub>PM0</sub>		456		μs	ADIFX compatible	
All Other Phases and Modes	t <sub>P</sub>		228		μs		
Initialization State (Phase 1)	t <sub>I</sub>		100		ms		
Device Data State (Phase 2)					ms		
Mode 0	t <sub>DD0</sub>		4.10		ms		
Mode 1	t <sub>DD1</sub>		109		ms		
Mode 2	t <sub>DD2</sub>		109		ms		
Mode 3	t <sub>DD3</sub>		117		ms		
Self-Test State (Phase 3)							
Self-Test Time <sup>3</sup>	t <sub>ST</sub>		394		ms		See Figure 28
Self-Test Interval	t <sub>STI</sub>		21.9		ms		See Figure 28
Self-Test Cycle	t <sub>STC</sub>		65.7		ms		See Figure 28
Auto-Zero Initialization State (Phase 4)	t <sub>AZ</sub>		14.94		sec		
<b>SYNCHRONOUS MODE TIMING<sup>4</sup></b>							
Message Transmission Period	t <sub>PS</sub>		N/A			Determined by sync pulse, See Figure 14, minimum t <sub>PS</sub> = t <sub>SPD</sub> + t <sub>STD</sub> + t <sub>M</sub> + t <sub>B</sub>	
Initialization State1 (Phase 1)	t <sub>I</sub>		100		ms		
Device Data State (Phase 2)					ms		
Mode 0	t <sub>DD0s</sub>		9 × t <sub>PS</sub>		ms		
Mode 1	t <sub>DD1s</sub>		480 × t <sub>PS</sub>		ms		
Mode 2	t <sub>DD2s</sub>		480 × t <sub>PS</sub>		ms		
Mode 3	t <sub>DD3s</sub>		512 × t <sub>PS</sub>		ms		
Self-Test State (Phase 3)							
Self-Test Time <sup>3</sup>	t <sub>STS</sub>		1728 × t <sub>PS</sub>		ms		
Self-Test Interval	t <sub>STIS</sub>		96 × t <sub>PS</sub>		ms		
Self-Test Cycle	t <sub>STCS</sub>		288 × t <sub>PS</sub>		ms		
Auto-Zero Initialization State (Phase 4)	t <sub>AZs</sub>		65,535 × t <sub>PS</sub>		sec		
<b>CLOCK</b>							
Period <sup>2</sup>	t <sub>CLK</sub>	1.05	1.0	0.95	μs		f <sub>CLK</sub> = 1/t <sub>CLK</sub>
<b>PSRR</b>							
			<1		LSB	8-bit LSB; test conditions: V <sub>BP</sub> – V <sub>BN</sub> = 7.00 V, V <sub>AC</sub> = 500 mV p-p, 100 kHz to 1.1 MHz	
<b>POWER SUPPLY HOLDUP TIME</b>							
			500		ns	@ I <sub>BUS</sub> = I <sub>SIG</sub>	
<b>THERMAL RESISTANCE, JUNCTION TO CASE</b>							
	θ <sub>JC</sub>		30		°C/W		

<sup>1</sup> All parameters are specified using the application circuit shown in Figure 6. C<sub>B</sub> = 10 nF, C<sub>VDD</sub> = 100 nF.

<sup>2</sup> All timing is driven from the on-chip master clock.

<sup>3</sup> t<sub>ST</sub> and t<sub>STS</sub> are the times for six self-test cycles. This is the maximum number of cycles in the internal self-test mode.

<sup>4</sup> Transmission timing is defined by the internal system clock in asynchronous mode and by the synchronization pulse period in synchronous mode.

## ABSOLUTE MAXIMUM RATINGS

Table 2.

Parameter	Rating
Supply Voltage ( $V_{BP} - V_{BN}$ )	-0.3 V to +21 V
Voltage at Any Pin with Respect to $V_{BN}$ Except $V_{BP}$	-0.3 V to $V_{DD} + 0.3$ V
Storage Temperature Range	-55°C to +150°C
Soldering Temperature	255°C
Operating Temperature Range	-40°C to +125°C
ESD All Pins	1.5 kV HBM
Latch-Up Current	100 mA
Mechanical Shock	
Unpowered	±4000 g (0.5 ms, half sine)
Powered	±2000 g (0.5 ms, half sine); -0.3 V to +7.0 V
Drop Test (onto Concrete) <sup>1</sup>	1.2 m
Thermal Gradient	±20°C/minute

<sup>1</sup> Soldered to FR4 coupon printed circuit board (PCB) at the dimensions of 25.4 mm × 25 mm. During test, the PCB is fastened to a support with 46 g mass, equivalent to a typical satellite module PCB.

Stresses above those listed under Absolute Maximum Ratings may cause permanent damage to the device. This is a stress rating only; functional operation of the device at these or any other conditions above those indicated in the operational section of this specification is not implied. Exposure to absolute maximum rating conditions for extended periods may affect device reliability.

### ESD CAUTION



**ESD (electrostatic discharge) sensitive device.** Charged devices and circuit boards can discharge without detection. Although this product features patented or proprietary protection circuitry, damage may occur on devices subjected to high energy ESD. Therefore, proper ESD precautions should be taken to avoid performance degradation or loss of functionality.

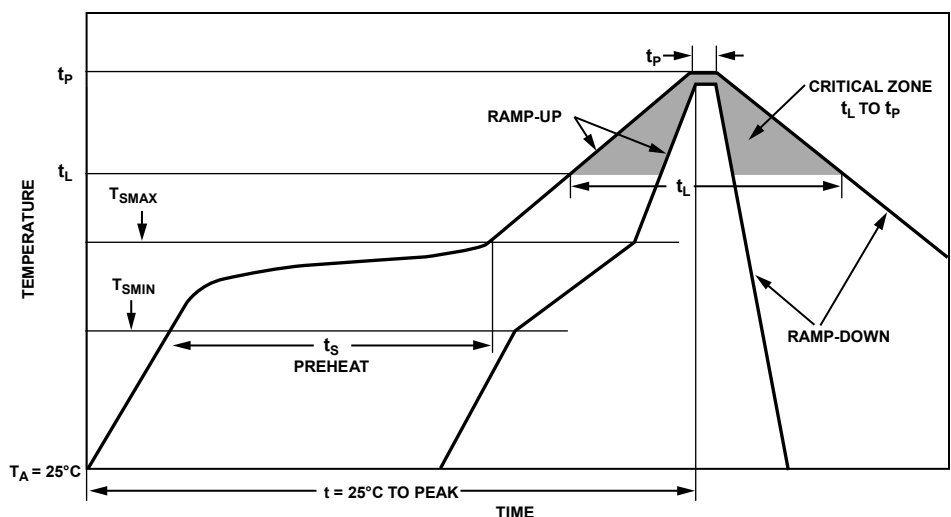

Figure 2. ADXL180 Pb-Free Solder Profile

Table 3. ADXL Solder Profile Parameters

Profile Feature	Small Body Pb-Free Assemblies
Average Ramp-Up Rate ( $T_L$ to $T_P$ )	3°C/second maximum
Preheat Temperature Min ( $T_S$ min) to Temperature Max ( $T_S$ max)	150°C to 200°C
Time (min to max) ( $t_s$ )	60 sec to 180 sec
$T_S$ max to $T_L$ Ramp-Up Rate	3°C/second maximum
Time Maintained Above Temperature ( $T_L$ )	217°C
Time ( $t_L$ )	60 sec to 150 sec
Peak Temperature ( $T_P$ )	260°C +5/-5°C
Time Within 5°C of Actual Peak Temperature ( $t_p$ )	20 sec to 40 sec
Ramp-Down Rate	6°C/sec maximum
Time 25°C to Peak Temperature	8 minutes maximum

## PIN CONFIGURATION AND FUNCTION DESCRIPTIONS

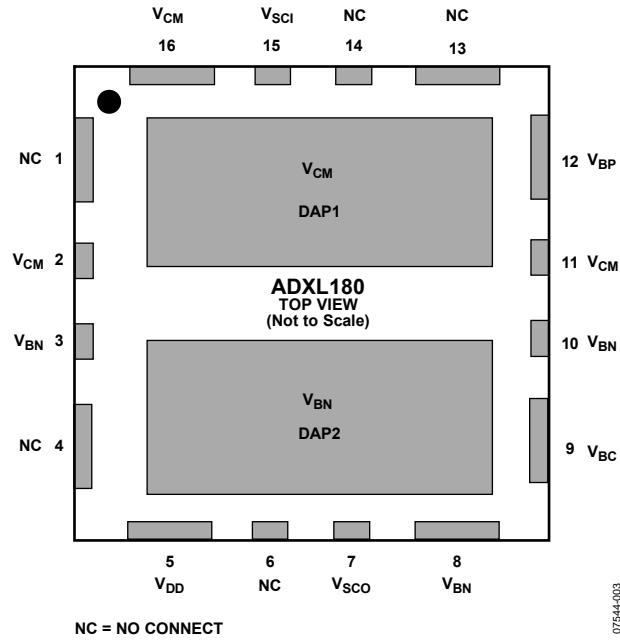

Figure 3. Pin Configuration

Table 4. Pin Function Descriptions

Pin No.	Mnemonic	Description
1	NC	Reserved for Analog Devices, Inc., Use Only. $V_{BN}$ or do not connect.
2	$V_{CM}$	Reserved for Analog Devices Use Only. Do not connect.
3	$V_{BN}$	Negative Bus Voltage.
4	NC	Reserved for Analog Devices Use Only. $V_{BN}$ or do not connect.
5	$V_{DD}$	Voltage Regulator Bypass Capacitor.
6	NC	Reserved for Analog Devices Use Only. $V_{BN}$ or do not connect.
7	$V_{SCO}$	Reserved for Analog Devices Use Only. Do not connect.
8	$V_{BN}$	Negative Bus Voltage.
9	$V_{BC}$	Daisy-Chain Connection. Daisy-chain connection to $V_{BP}$ of the second device or do not connect.
10	$V_{BN}$	Negative Bus Voltage.
11	$V_{CM}$	Reserved for Analog Devices Use Only. Do not connect.
12	$V_{BP}$	Positive Bus Voltage.
13	NC	Reserved for Analog Devices Use Only. $V_{BN}$ or do not connect.
14	NC	Reserved for Analog Devices Use Only. $V_{BN}$ or no connect
15	$V_{SCI}$	Analog Signal Chain Input. $V_{BN}$ when not in use.
16	$V_{CM}$	Reserved for Analog Devices Use Only. Do not connect.
DAP1	$V_{CM}$	Exposed Pad: Reserved for Analog Devices Use Only. Do not connect.
DAP2	$V_{BN}$	Exposed Pad: Negative Bus Voltage.



## TERMINOLOGY

### Full-Scale Range (FSR)

The full-scale range of a device, also referred to as the dynamic range, is the maximum and minimum  $g$  level that reports on the output following the internal filtering. As a reference, there is usually a trade-off in increased sensitivity and resolution for decreased full-scale range, and vice versa.

### Noise

Device noise is the noise content between 10 Hz and 400 Hz, as noted in the Specifications Table 1. Device noise can be measured by performing an FFT on the digital output and measuring the noise content between the specified frequency limits.

### Sensitivity

The sensitivity of a device is the amount of output change per input change. In this device, it is most usually referred to in units of LSB/ $g$ .

### Scale Factor

The scale factor is the amount of input change per output change. In this device, it is most usually referred to in units of  $g$ /LSB.

### Offset

Offset is the low frequency component of the output signal that is not due to changes in input acceleration. Slow moving effects, such as temperature changes and self-heating during start up, may affect offset, but the time scale for these effects is beyond that of a typical shock or crash event.

### Auto-Zero

Auto-zero is an offset compensation technique intended to reduce the long term offset drift effects of temperature and aging. This technique is designed to limit interaction with true acceleration signals. For more information, see Figure 32.

### Rise/Fall Times

The device rise time is defined as the amount of time necessary for the Manchester encoded signal ( $I_{MOD}$ ) to transition from 10% to 90% of its final value ( $I_{SIG}$ ). Device fall time is the amount of time required for the  $I_{MOD}$  signal to fall from 90% of  $I_{SIG}$  to within 10% of  $I_{IDLE}$ .

### Idle Current

Idle current is the current of the device when at rest, waiting for a synchronization pulse, or in between current modulation.

### Modulation Current

Modulation current is the amount of current that the ADXL180 device pulls from the bus when communicating. For more information, see Figure 7.

### Phase

A phase is a stage in the ADXL180 state machine. For more information, see Figure 22.

### Mode

Mode refers to the selection of the Phase 2 method of device data communication. The ADXL180 is configurable into four unique operating modes.

### CRC

A cyclic redundancy check (CRC) is calculated from a set of data and then transmitted alongside that data. If the calculation technique is defined and known to the receiving device, the receiver can then check whether the CRC bits match the data. If they do not match, a transmission error has occurred.

### Parity

Parity is defined by the count of 1s in a binary string of data. If this count is even, then the data is determined to have even parity. Often a bit is used, such as the CUPAR, in a configuration register that is defined in such a way as to establish a particular parity in the register to detect single bit changes during the life of the device. This is possible because a single bit change changes parity and a monitor circuit can detect this. Similarly, a parity bit can be added in a data transmission to detect single bit errors if the parity of communication is preestablished for the transmit and receive systems.

## THEORY OF OPERATION

### OVERVIEW

The ADXL180 is a complete satellite system, including acceleration sensor, data filtering, digital protocol functionality, and a 2-wire, high-voltage, current-modulated bus interface communications port.

### ACCELERATION SENSOR

The ADXL180 provides a fully differential sensor structure and circuit path. This device uses electrical feedback with zero force feedback. Figure 4 is a simplified view of one of the differential sensor elements. Each sensor includes several differential capacitor unit cells. Each cell is composed of fixed plates attached to the substrate and movable plates attached to the frame. Displacement of the frame changes the differential capacitance, which the on-chip circuitry measures.

Complementary signals drive the fixed capacitor plates. The relative phasing between the two halves of the differential

sensor is such that the displacement signal is differential between the two measurement channels. Using the fully differential sensor and an antiphase clocking scheme helps reject electrical environmental noise (see Figure 5).

The ADXL180 acceleration sensor uses two electrically isolated, mechanically coupled sensors to measure acceleration as shown in Figure 5. The clock phasing of the readout is such that the electrical signal due to acceleration is differential between the channels and environmental disturbances couple in as a common-mode signal. The following differential amplifier can then extract the acceleration signal while suppressing the environmental noise.

Electrical feedback adjusts the amplitudes of the fixed capacitor plates' drive signals such that the ac signal on the moving plates is zero. The feedback signal is linearly proportional to the applied acceleration. This feedback technique ensures that there is no net electrostatic force applied to the sensor.

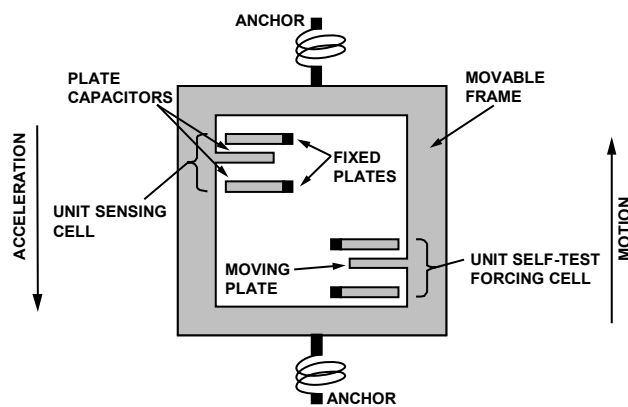

Figure 4. Simplified View of ADXL180 Sensor Under Acceleration

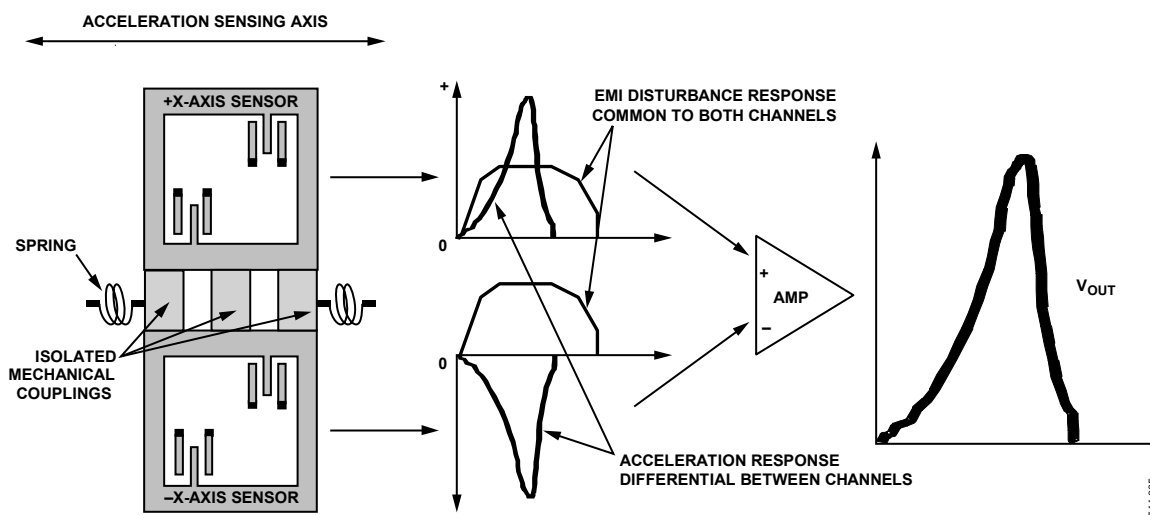

Figure 5. Differential Acceleration Sensing

## SIGNAL PROCESSING

The ADXL180 contains an on-board set of signal processing blocks both prior to and after ADC conversion. The first stage is a fully differential, switched capacitor, low-pass, three-pole Bessel filter. Range scaling is also handled in one of the filter blocks, enabling 50 g to 500 g range capability. At this point, an analog output test signal ( $V_{SCO}$ ) is available to the user in a diagnostic mode. The signal then converts by a 10-bit rail-to-rail SAR ADC. In the digital section, an auto-zero routine is available to the user as part of the state machine in addition to error detection features such as offset drift detection.

## DIGITAL COMMUNICATIONS STATE MACHINE

The ADXL180 digital state machine is based on a Core 5 phase state machine implemented in high density CMOS. This state machine handles the sequential states of

- Phase 1. Initialization.
- Phase 2. Device data transmission, including individual serial number and user-programmed data.
- Phase 3. Self-diagnostic, including automatic full electro-mechanical self-test with internal error detection available.
- Phase 4. Auto-zero initialization, if selected. During this phase, acceleration data is already available.
- Phase 5. Normal acceleration data transmission.

## 2-WIRE CURRENT MODULATED INTERFACE

The data that is generated during these five phases is transmitted using a 2-wire high voltage communication port. This allows the device to be powered by a fixed supply voltage, and communicate back to the system or ECU electronics by modulating current. Current modulated messages are encoded using Manchester encoding.

## SYNCHRONOUS OPERATION AND DUAL DEVICE BUS

In a point-to-point bus topology, the ADXL180 supports asynchronous transmission of data to the receive device every 228  $\mu$ s, controlled by the on-board state machine. A synchronous option is also available, allowing two devices to be on the same bus using time division multiplexing where each device transmits its data during a known time slot.

Synchronization is achieved by voltage modulated synchronization pulses, configuring the ADXL180 device into a synchronous mode, and establishing data frame time slots. The high voltage communication port registers valid synchronization pulses and enables message-by-message advancement of the state machine rather than asynchronous timed regular data transmission.

## PROGRAMMED MEMORY AND CONFIGURABILITY

### Factory-Programmed Serial Number and Manufacturer Information

The ADXL180 includes a 32-bit factory-programmed serial number, as shown in Table 5. This serial number transmits during Phase 2 of startup for all devices to enable robust quality tracking of individual devices, and it is field readable. In addition, this data includes revision information and manufacturer identification in case multiple devices used within a single application are from different manufacturers or generations of parts.

### User-Programmable Data Register

The ADXL180 gives the user an 8-bit register of user-programmable data, which is transmitted during Phase 2 of the state machine. In addition, the UD8 bit, a ninth user-available bit, is transmitted separately during Phase 2 and can be used for various purposes, such as orientation definition or module type.

**Table 5. Factory Programmed and User-Programmed Memory**

Programmed By	Configuration Mode Register Address	Configuration Mode Register Name	MSB								LSB
			D7	D6	D5	D4	D3	D2	D1	D0	
User	0000b	UREG	UD7	UD6	UD5	UD4	UD3	UD2	UD1	UD0	
	0001b	CREG0	UD8	BDE	MD1	MD0	FDLY	DLY2	DLY1	DLY0	
	0010b	CREG1	STI	AZE	SYEN	ADME	ERC	SVD	DAT	MAN	
	0011b	CREG2	CUPRG	CUPAR	SCOE	FC1	FC0	RG2	RG1	RG0	
Factory	1011b	SN0	SNB7	SNB6	SNB5	SNB4	SNB3	SNB2	SNB1	SNB0	
	1100b	SN1	SNB15	SNB14	SNB13	SNB12	SNB11	SNB10	SNB9	SNB8	
	1101b	SN2	SNB23	SNB22	SNB21	SNB20	SNB19	SNB18	SNB17	SNB16	
	1110b	SN3	SNB31	SNB30	SNB29	SNB28	SNB27	SNB26	SNB25	SNB24	
	1111b	MFGID	SNPRG	SNPAR	REV2	REV1	REV0	MFGID2	MFGID1	MFGID0	

## ***User-Programmed Configuration***

At each of these previously described points in the system, the ADXL180 is highly configurable for different applications. The organization and configurable items are briefly described in this section but are covered in depth in the remainder of this data sheet.

### **Physical Layer (ISO Layer 1)**

The bus interface hardware definition including the phase of Manchester encoding and synchronization pulse enable/disable.

### **Data Link Layer (ISO Layer 2)**

The specifics of the data frame format including the data width (8-bit or 10-bit data), state vector (enable/disable), and error detection (parity or CRC).

### **Application Layer (ISO Layer 7)**

The serial number and configuration data transmission mode and self-test (internal self-test pass/fail discrimination or external self-test data evaluation).

Other signal processing related aspects of the function of the ADXL180 can also be configured as follows:

- Sensor scale factor (range)
- Signal chain low-pass filter bandwidth
- Auto-zero: enable/disable
- User-defined data in the user data register

## PHYSICAL INTERFACE

### APPLICATION CIRCUIT

A typical application circuit is shown in Figure 6. The two capacitors shown in Figure 6 are typically ceramic, X7R, multilayer SMT capacitors. Maximum recommended values of ESR and ESL are 250 mΩ and 2 nH, respectively. Capacitor tolerances of ±10% are recommended.

### CURRENT MODULATION

When the ADXL180 device is powered on, it uses current modulation to transmit data. Normally, the device pulls  $I_{IDLE}$  current. When modulating, an additional current of  $I_{MOD}$  is pulled from the sensor bus. See Figure 7.

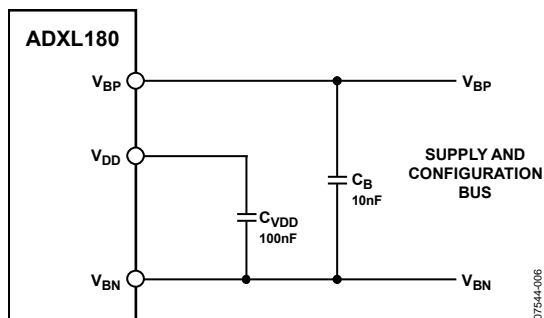

Figure 6. Application Circuit

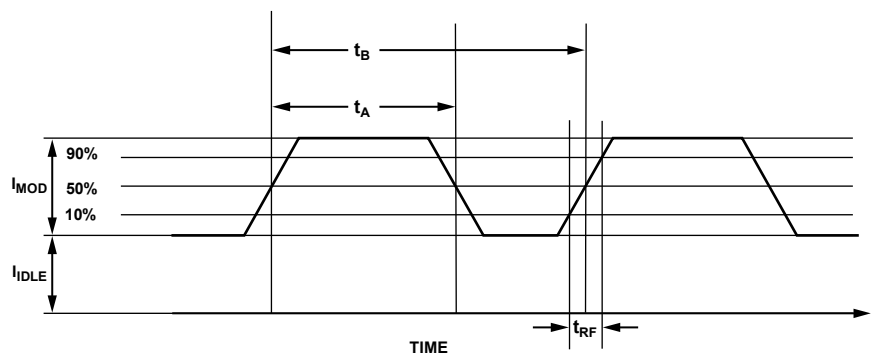

Figure 7. Communication Current Modulation Timing

## MANCHESTER DATA ENCODING

To encode data within the current modulation, the ADXL180 uses Manchester encoding. Manchester encoding works on the principle of transitions representing binary 1s and 0s, as shown in Figure 8. Manchester encoding uses a set of predefined start bits to transmit the clocking within each message, see Figure 9. The pattern of the start bits allows the receiver to synchronize itself to the bit stream. These start bits are user selectable.

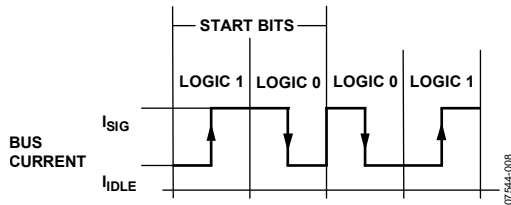

Figure 8. Manchester-1, Start Bits and Phase

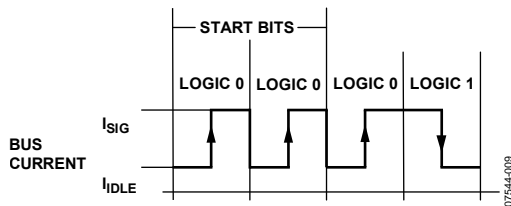

Figure 9. Manchester-2, Bit Coding

Table 6. MAN Options

MAN	Manchester Coding	Start Bits	Logic 0	Logic 1
0	Manchester-1 (Default)	1, 0	Falling edge	Rising edge
1	Manchester-2	0, 0	Rising edge	Falling edge

The phase of the Manchester encoded data can be selected via a bit in the configuration registers. See Figure 8 and Figure 9 for details. The configuration bit that sets the phase of the Manchester encoder also sets the value of the two start bits. The start bits are 1, 0 for Manchester-1 and 0, 0 for Manchester-2. For phase and start bit information, see Table 6.

### OPERATION AT LOW $V_{BP}$ OR LOW $V_{DD}$

The ADXL180 monitors its internal regulator voltage to ensure proper operation. If the bus voltage drops, or the internal regulator voltage drops below the  $V_{PUR}$  reset threshold, the device resets. See the Voltage Regulator Monitor Reset Operation section.

### OPERATION AT HIGH $V_{DD}$

If the regulator pin detects a high voltage, such as from a short or leakage condition, the ADXL180 detects an error. See the Voltage Regulator Monitor Reset Operation section for more details.

## COMMUNICATIONS TIMING AND BUS TOPOLOGIES

### DATA TRANSMISSION

The analog data (available to the user by enabling the  $V_{SCO}$  output) is sampled every  $228\ \mu\text{s}$  when the device is configured to run asynchronously. In synchronous operation, an ADC conversion is triggered upon the detection of a valid sync pulse. In both cases, the data is held until a subsequent ADC conversion is performed. This results in an additional time delay of either  $228\ \mu\text{s}$  or one sync pulse period from the

sampling of the analog data to when it is transmitted via manchester encoded data. Analog-to-digital conversions are performed prior to the device entering run-time mode (Phase 5) thereby ensuring that the data from the ADC is never in an unknown state. This holds true upon receipt of the first sync pulse in run-time mode (Phase 5).

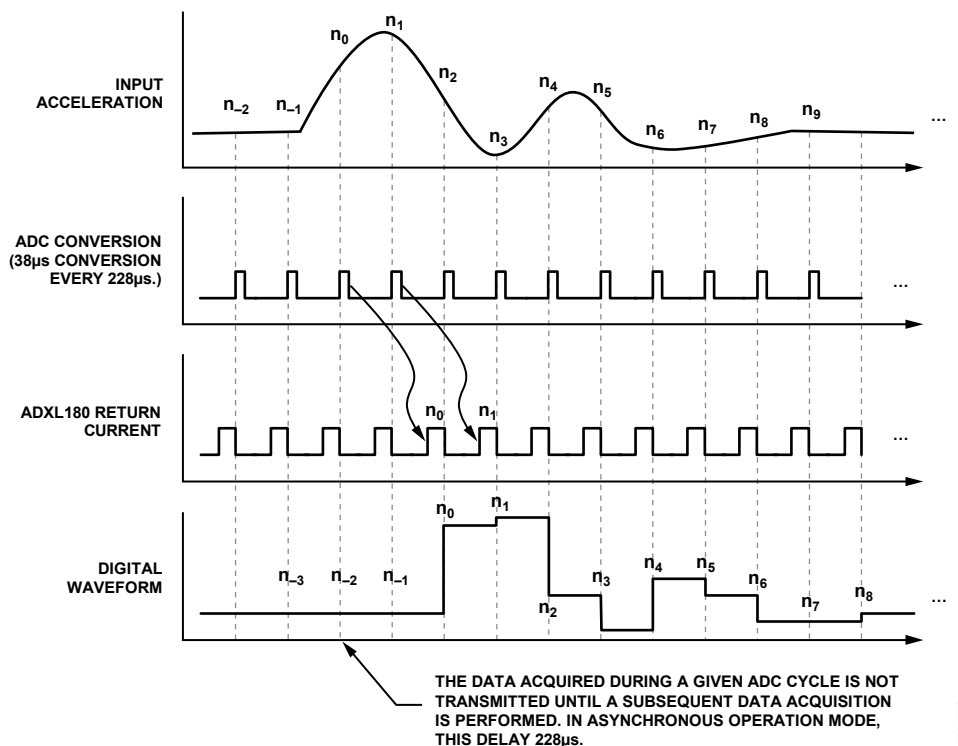

Figure 10. Asynchronous Data Transmission (Timing Not To Scale)

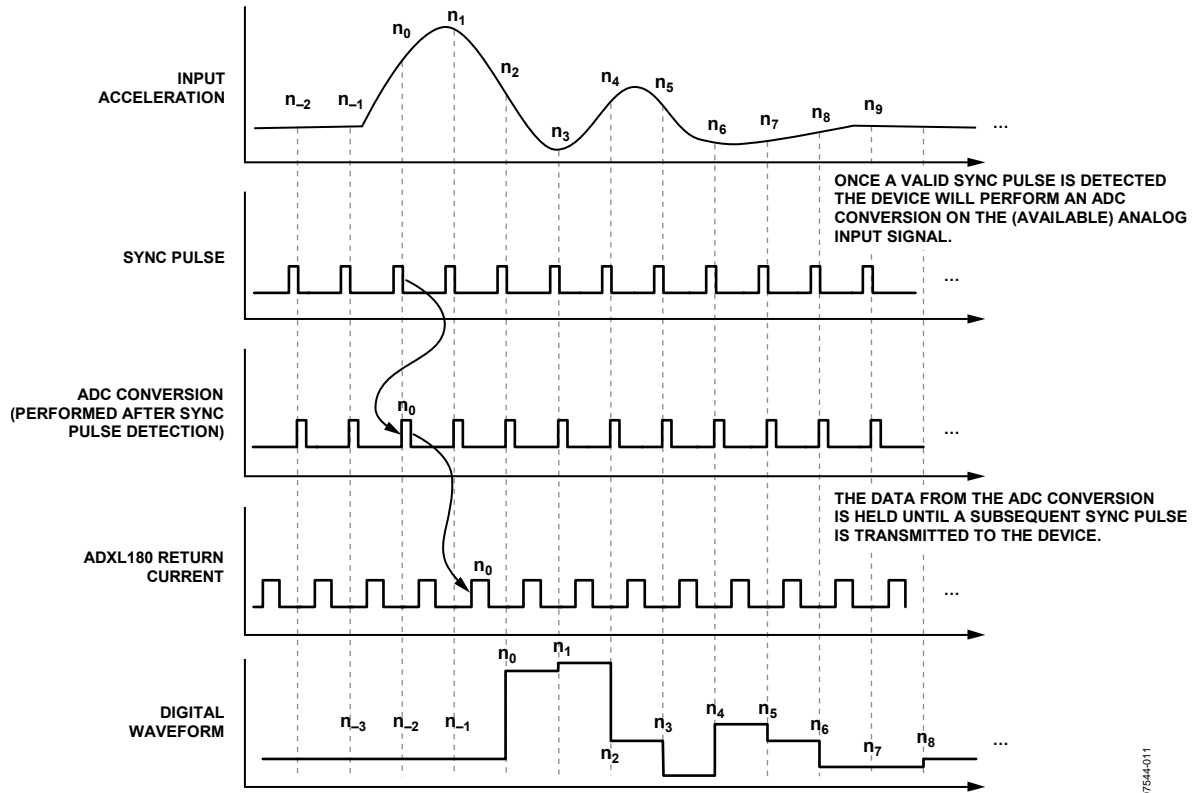

Figure 11. Synchronous Data Transmission (Timing Not To Scale)

07544-011

## ASYNCHRONOUS COMMUNICATION

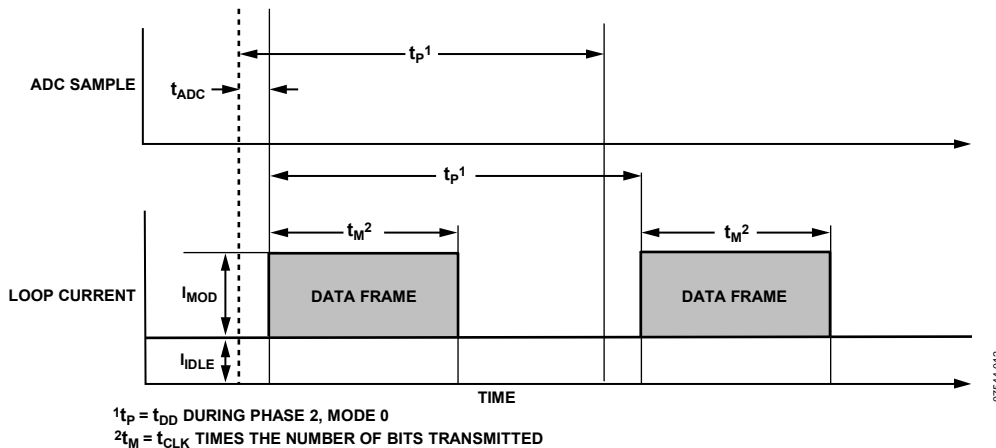

Figure 12. Asynchronous Mode Data Transmission Timing

07544-012

The ADXL180 data transmissions in their default mode run asynchronous to the control module. In this mode, the ADXL180 timing is entirely based on the internal clock of the device. After the initialization phases are complete, the ADXL180 begins to transmit sensor data every 228  $\mu$ s. The device transmits sensor data until the supply voltage falls below the required minimum operating level. If an internal error is detected, the device transmits the appropriate error code until the supply voltage falls below the required minimum operating level.

### Asynchronous Single Device Point-to-Point Topology

A single device is wired in the point-to-point configuration as shown in Figure 13. This configuration must be used in asynchronous mode. Do not use two asynchronous devices on one bus because communications errors are very likely to occur.





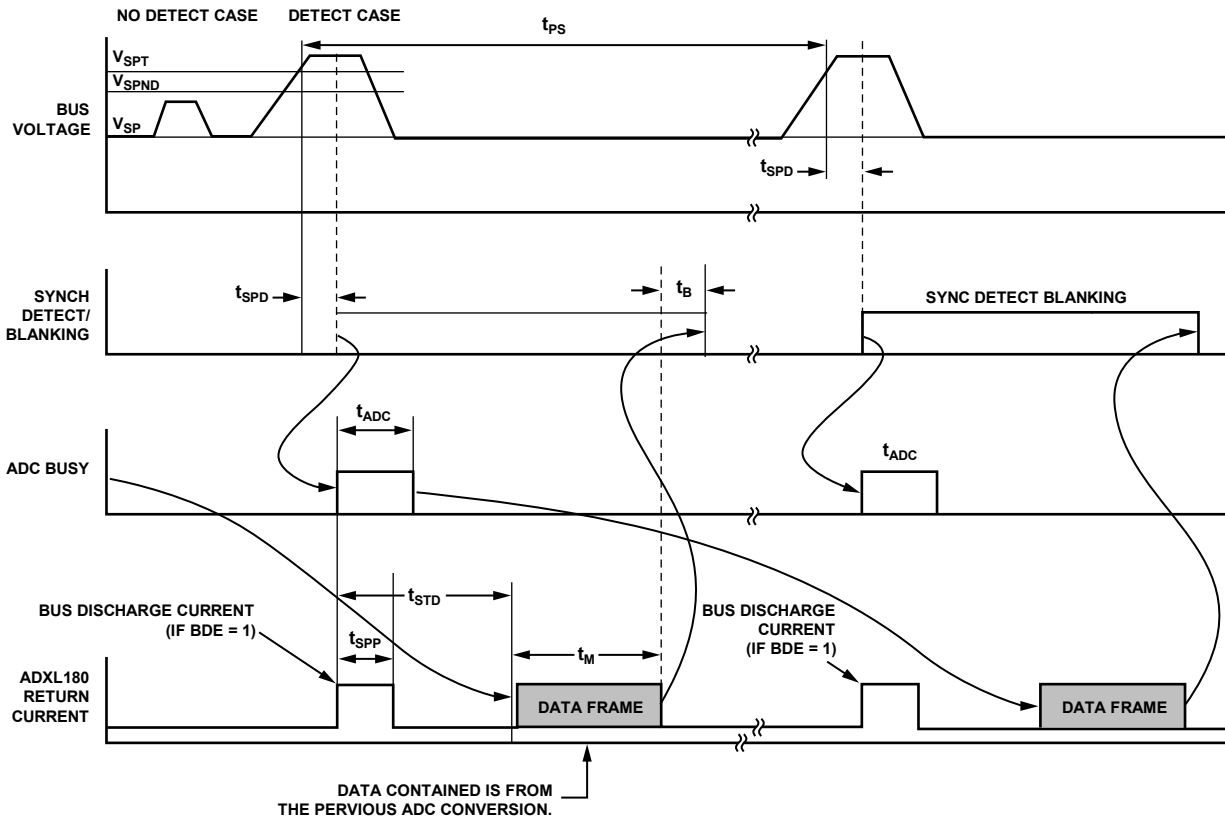

07544-014

Figure 14. Synchronization Pulse Timing (Single Device)

### Synchronous Single Device Point-to-Point Topology

A single device is wired in the point-to-point configuration as shown in Figure 15. The standard use of this configuration is with no delay devices. It is possible to use this topology with fixed delay devices as well, such as if line noise reduction after a sync pulse transmission is desired.

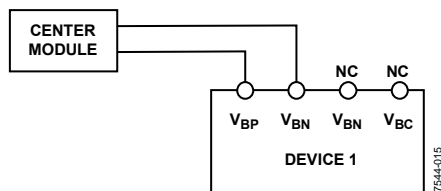

Figure 15. Single Device—Synchronous Communication

### SYNCHRONOUS COMMUNICATION MODE—DUAL DEVICE

The ADXL180 can be used in a dual device synchronous communication mode. This mode allows a maximum of two

ADXL180 devices to share a single pair of wires from the control module for power and communications. This is accomplished using time division multiplexing where each device transmits its data during a known time slot. The time slot used by each device is determined by the delay time from detection of a synchronization pulse to the beginning of data transmission. The data transmission delay time is selectable in the configuration registers. The following discussion uses the convention that the first time slot is named Time Slot A and the second time slot is named Time Slot B (see Figure 16). The two ADXL180 devices can be wired in either a parallel or series mode as described in the following sections. If a synchronization pulse is not detected, no data is sent. This is true for all initialization phases and normal run-time operation. Note that the minimum synchronization pulse period is

$$t_{SPD} + t_{DLY} + t_M + t_B$$

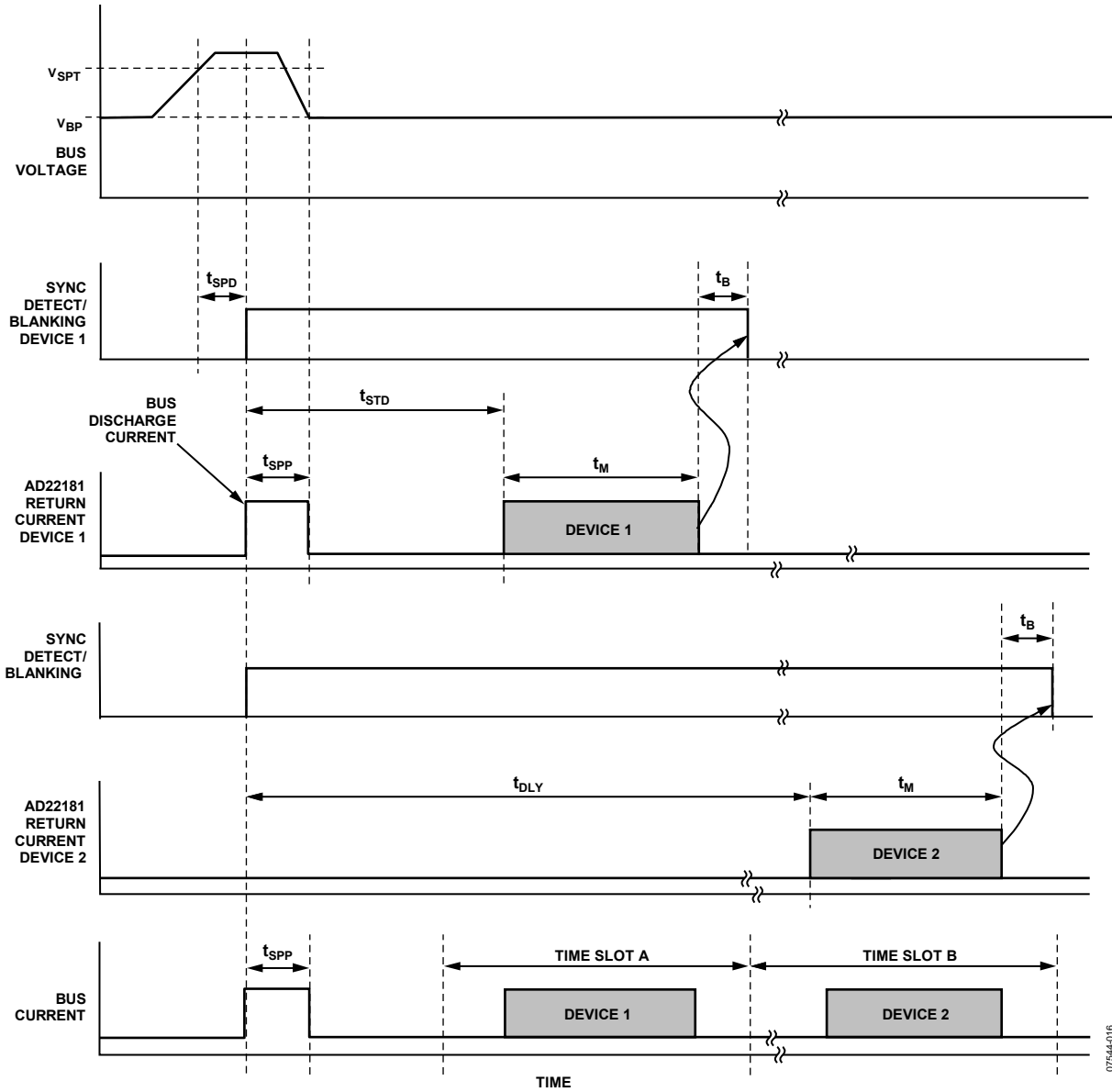

Figure 16. Synchronization Pulse Timing (Dual Device)

07544-016





## DATA FRAME DEFINITION

### DATA FRAME TRANSMISSION FORMAT

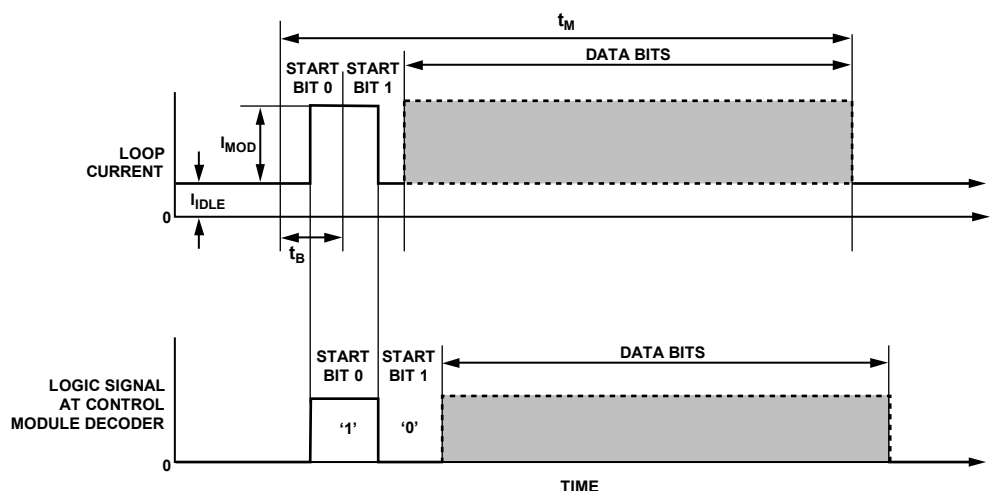

Figure 19. Data Message Timing (Manchester-1, Bit Coding)

A data frame starts with two start bits. The value of these two bits is determined by the Manchester encoding mode select bit. See the Manchester Data Encoding section. Figure 19 shows the basic format and timing of the data frame. A 1-bit idle time is an implicit stop bit at the end of a data frame.

### DATA FRAME CONFIGURATION OPTIONS

Figure 20 diagrams the protocol data frame construction options. The data frame can be broken into four specific fields as follows:

- Start bits—two start bits are always transmitted at the start of the data frame. These bits are used to synchronize the center module decoder with the Manchester encoded signal.

- Error checking—a single parity bit or a 3-bit CRC code can be selected.
- State vector—identifies the type of data in the data field. It can be disabled. When it is disabled, it is not transmitted.
- Data—the device data and sensor data can be transmitted in either 8-bit or 10-bit mode.

Depending on the settings of the configuration register bits (ERC, SVD, and DAT), the data frame can be from 11 bits to 18 bits in length. Figure 20 shows the formats of the available data frames. Note that the error checking field is transmitted first when the CRC is selected but transmitted last when parity is selected. See Figure 20 for specific examples of full protocol configurations.

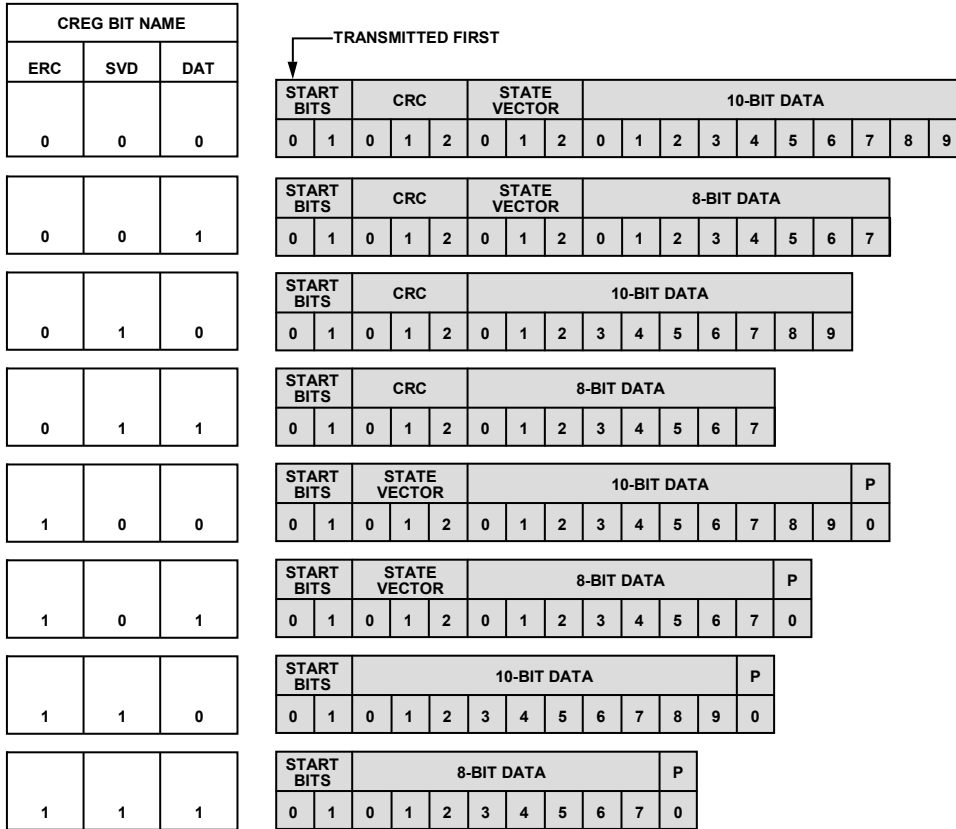

Figure 20. Data Frame Formats

07544-020



## ACCELERATION DATA CODING

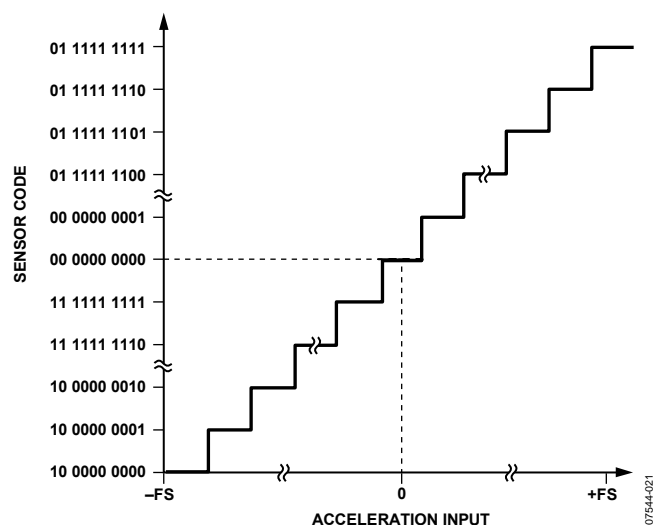

Figure 21. 10-Bit ADC Transfer Characteristic

Table 12. DAT Data Bit Options

DAT	Definition
0	10-bit data sensor data transmitted. 8-bit Phase 2 configuration data left justified in 10-bit data frame (default).
1	8-bit sensor data transmitted.

The sensor data coding is dependent on the configuration register bit settings. Either 8-bit or 10-bit sensor data can be transmitted. This 8-bit or 10-bit data range is either full range or reduced range. Whether the data range is full or reduced depends on the setting of the state vector disable and auto-zero enable configuration register bits. For more information, see Table 13.

Table 13. Full and Reduced Sensor and Device Data Ranges

SVD <sup>1</sup>	AZE <sup>2</sup>	Data Range
0	0	Full
0	1	Reduced
1	0	Reduced <sup>3</sup>
1	1	Reduced <sup>3</sup>

<sup>1</sup> SVD is the state vector disable configuration bit.

<sup>2</sup> AZE is the auto-zero enable configuration bit.

<sup>3</sup> A configuration error is reported if Phase 2 Mode 0 is selected with the state vector disabled (SVD = 1). The ADXL180 transmits a configuration error code during run time and no sensor data is transmitted.

Table 14. 8-Bit Full Sensor Data Range Coding

Decimal	Hex	Binary (Twos Complement)	Description
+127	0x7F	0111 1111	Most positive (+FS) acceleration value
+126	0x7E	0111 1110	...
+125	0x7D	0111 1101	...
...	...	...	...
+1	0x01	0000 0001	...
0	0x00	0000 0000	Zero (0) acceleration value
-1	0xFF	1111 1111	...
...	...	...	...
-126	0x82	1000 0010	...
-127	0x81	1000 0001	...
-128	0x80	1000 0000	Most negative (-FS) acceleration value

Table 15. 10-Bit Full Sensor Data Range Coding

Decimal	Hex	Binary (Twos Complement)	Description
+511	0x1FF	01 1111 1111	Most positive (+FS) acceleration value
+510	0x1FE	01 1111 1110	...
+509	0x1FD	01 1111 1101	...
...	...	...	...
+1	0x01	00 0000 0001	...
0	0x00	00 0000 0000	Zero (0) acceleration value
-1	0x3FF	11 1111 1111	...
...	...	...	...
-510	0x202	10 0000 0010	...
-511	0x201	10 0000 0001	...
-512	0x200	10 0000 0000	Most negative (-FS) acceleration value

Table 16. 8-Bit Reduced Sensor Data Range Coding

Decimal	Hex	Binary (Twos Complement)	Description
+116	0x74	0111 0100	Most positive (+FS) acceleration value
...	...	...	...
0	0x00	0000 0000	Zero (0) acceleration value
...	...	...	...
-116	0x8C	1000 1100	Most negative (-FS) acceleration value

Table 17. 10-Bit Reduced Sensor Data Range Coding

Decimal	Hex	Binary (Twos Complement)	Description
+464	0x1D0	01 1101 0000	Most positive (+FS) acceleration value
...	...	...	...
0	0x000	00 0000 0000	Zero (0) acceleration value
...	...	...	...
-464	0x230	10 0011 0000	Most negative (-FS) acceleration value

# ADXL180

## STATE VECTOR CODING

Table 18. SVD Data Bit Options

SVD	Definition
0	State vector is enabled (default).
1	State vector is disabled, a reduced data range is used.

The 3-bit state vector field contains a code that defines the meaning of the data contained in the 8- or 10-bit data field. These definitions are listed in Table 19. When selected, the 3-bit state vector is appended to the 8- or 10-bit data field and transmitted as part of the data frame.

## STATE VECTOR DESCRIPTIONS

Table 19. State Vector Table

SV2	SV1	SV0	State	Phase <sup>1</sup>	Data In Frame	Description
0	0	0	Normal operation	5	Sensor data	This is the running state of the ADXL180. During this state, an analog-to-digital conversion is performed, and the resulting sensor data is transmitted every 228 $\mu$ s in asynchronous mode or every 250 $\mu$ s in synchronous mode.
0	0	1	Device data	2	Serial number/manufacturer ID/range/user and configuration register data	The data field contains serial number and/or configuration data. See the ADXL180 State Machine section for the device data transmission specifics for each MD1 to MD0 selection.
0	1	0	Self Test 0	3	Sensor data with the self-test signal unasserted	The ADXL180 is in sensor self-test mode. The internal sensor self-test signal is unasserted.
0	1	1	Self Test 1	3	Sensor data with the self-test signal asserted	The ADXL180 is in sensor self-test mode. The internal sensor self-test signal is asserted.
1	0	0	Auto-zero initialization	4	Sensor data	The ADXL180 is in Phase 4. The auto-zero function is running in the fast initialization mode.
1	0	1	OTP memory data	NA	OTP memory data (configuration mode data)	This state vector indicates that the data sent is from the OTP memory of the ADXL180. This data type is only sent when the device is in configuration mode.
1	1	0	Status/error	NA	Status/error data (see Table 39)	This state is set when an internal error is detected by the ADXL180. The data field contains the error type. See the Error Detection section for details.
1	1	1	Reserved	NA	Reserved	

<sup>1</sup> NA is not applicable.

## TRANSMISSION ERROR DETECTION OPTIONS

There are two error checking methods available: a 3-bit CRC and a 1-bit parity check. These are determined by the user-selected Bit ERC.

**Table 20. Error Check (ERC) Bit Options**

ERC	Definition
0	A 3-bit CRC is included in the message. CRC is calculated using the polynomial $x^3 + x^1 + x^0$ . (Default.)
1	One parity bit is included in the message. CRC is not used. It is a bit that is set such that even parity is achieved in the transmitted message.

### **CRC Encoding**

The ADXL180 can be programmed to utilize a 3-bit CRC. The polynomial used for the encoding is  $x^3 + x^1 + x^0$ . The CRC

calculation is performed from MSB to LSB on the entire data frame. The CRC state registers are initialized to zero. Therefore, when checking the result of the transmission, the final CRC check state should be zero. The three CRC bits are always the three least significant bits in the transmission.

### **Parity Encoding**

The ADXL180 can be programmed so that the LSB of each data transmission contains a 1-bit parity check bit. The 1-bit parity check is even parity. The parity algorithm sets the parity bit to be either a one or a zero; thus, the resulting number of ones transmitted in the data frame is always an even number.

## APPLICATION LAYER: COMMUNICATION PROTOCOL STATE MACHINE

Table 21. ADXL180 Start-Up Sequence Summary

Name	Phase 1 Initialization	Phase 2 Device Data	Phase 3 Self-Test	Phase 4 Auto-Zero Initialization	Phase 5 Run Time
Function	Power-on reset	None	Sequence self-test pattern	Fast auto-zero	Slow auto-zero
Data Type Transmitted	None	Serial number, configuration and range	Sensor, range, device OK or delimiter	Sensor	Sensor

### ADXL180 STATE MACHINE

After power is applied and stabilized, the ADXL180 follows a five-phase start-up sequence. The basic function of each phase is fixed as shown in Figure 22. The five phases and the function modes available in each phase are detailed in the following sections.

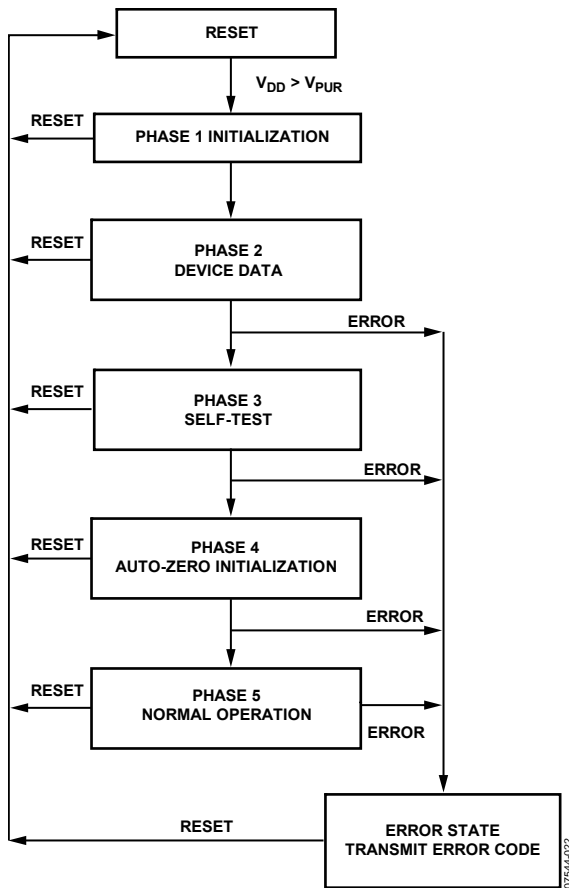

Figure 22. ADXL180 Start-Up Sequence

### PHASE 1: POWER-ON-RESET INITIALIZATION

The power-on-reset initialization period is typically 100 ms long. It is the period of time from when the internal reset signal is deasserted until the beginning of Phase 2. This time allows for circuit stabilization and entry into configuration mode. No data is transmitted during Phase 1. No errors are reported during Phase 1. Additionally, until phase 1 is exited, the device does not respond to a transmitted sync pulse (see Table 21).

### PHASE 2: DEVICE DATA TRANSMISSION

#### Overview

The device data consists of the serial number and configuration data. Device data is transmitted during Phase 2. This data can be transmitted in one of four configurable modes (see Table 22). These modes are described in detail in the following sections. The parity of all OTP memory blocks is continuously monitored (provided that the block has been programmed) beginning at the end of Phase 2. See the Parity Encoding section for more details.

Table 22. MD Phase 2 Device Data Mode Select Codes

MD1	MD0	Name	Definition
0	0	Mode 0	ADIFX mode device data (default)
0	1	Mode 1	Range data only (range selection limited)
1	0	Mode 2	8-bit coded device data
1	1	Mode 3	10-bit coded device data

During Phase 2, if Mode 0, Mode 1, or Mode 2 is selected, the device data is 8-bit data. If the 10-bit data mode is selected in combination with Phase 2 Mode 0, Mode 1, or Mode 2, the 8-bit device data is left justified in the 10-bit data field. The two LSBs are held at zero (see Table 24).

**Influence of MD on Data Range****Table 23. MD Settings and Device Data Ranges**

Mode (Device Data)	MD1	MD0	SVD <sup>1</sup>	AZE <sup>2</sup>	Data Range
0: ADIFX <sup>3</sup> (All Configuration Data, Serial Number, and Manufacturer ID)	0	0	0	0	Full
	0	0	0	1	Reduced
	0	0	1	0	Configuration error
	0	0	1	1	Configuration error
1: Range Data Only <sup>3</sup> (Limited Range Selection)	0	1	0	0	Full
	0	1	0	1	Reduced
	0	1	1	0	Reduced
	0	1	1	1	Reduced
2: 8-Bit Coded Device Data <sup>3</sup> (UD[7:0], Serial Number, and Range)	1	0	0	0	Full
	1	0	0	1	Reduced
	1	0	1	0	Reduced
	1	0	1	1	Reduced
3: 10-Bit Coded Device Data <sup>4</sup> (UD[7:0], Serial Number, and Range)	1	1	0	0	Full
	1	1	0	1	Reduced
	1	1	1	0	Reduced
	1	1	1	1	Reduced

<sup>1</sup> SVD is the state vector disable configuration bit.

<sup>2</sup> AZE is the auto-zero enable configuration bit

<sup>3</sup> If Phase 2 Mode 0, Mode 1, or Mode 2 is selected, the device data is 8-bit data. If the 10-bit data mode is selected in combination with Phase 2 Mode 0, Mode 1, or Mode 2, the 8-bit device data is left justified in the 10-bit data field. The two LSBs are held at zero (see Table 24).

<sup>4</sup> The 10-bit device data mode (Phase 2 Mode 3) is incompatible with the 8-bit data mode (the DAT bit is set to 1). The device transmits a configuration error code if Phase 2 Mode 3 is selected and the DAT bit is set to 1. No sensor data is transmitted.

**Device Data Mapping in Phase 2****Table 24. Phase 2 Device Data Bit Mapping in 10-Bit Sensor Data Mode**

DB9	DB8	DB7	DB6	DB5	DB4	DB3	DB2	DB1	DB0
Device Data MSB	Device Data	Device Data	Device Data	Device Data	Device Data	Device Data	Device Data LSB	0	0

**Table 25. Phase 2 Device Data Bit Mapping in 8-Bit Sensor Data Mode**

DB7	DB6	DB5	DB4	DB3	DB2	DB1	DB0
Device Data MSB	Device Data	Device Data	Device Data	Device Data	Device Data	Device Data	Device Data LSB

## PHASE 2: MODE DESCRIPTION

### Mode 0

The Mode 0 option for Phase 2 transmits the entire contents of the configuration registers, the serial number and the manufacturer ID byte. The total number of messages transmitted during Phase 2, Mode 0 is 9.

### Asynchronous Mode

The device data is transmitted at a time interval of 456  $\mu$ s based on the internal clock of the ADXL180. The 456  $\mu$ s period is twice the normal transmission time interval of 228  $\mu$ s.

### Synchronous Mode

In synchronous mode, the device data is transmitted in response to the synchronization pulse generated by the control module. See the Synchronization Pulse Detection section.

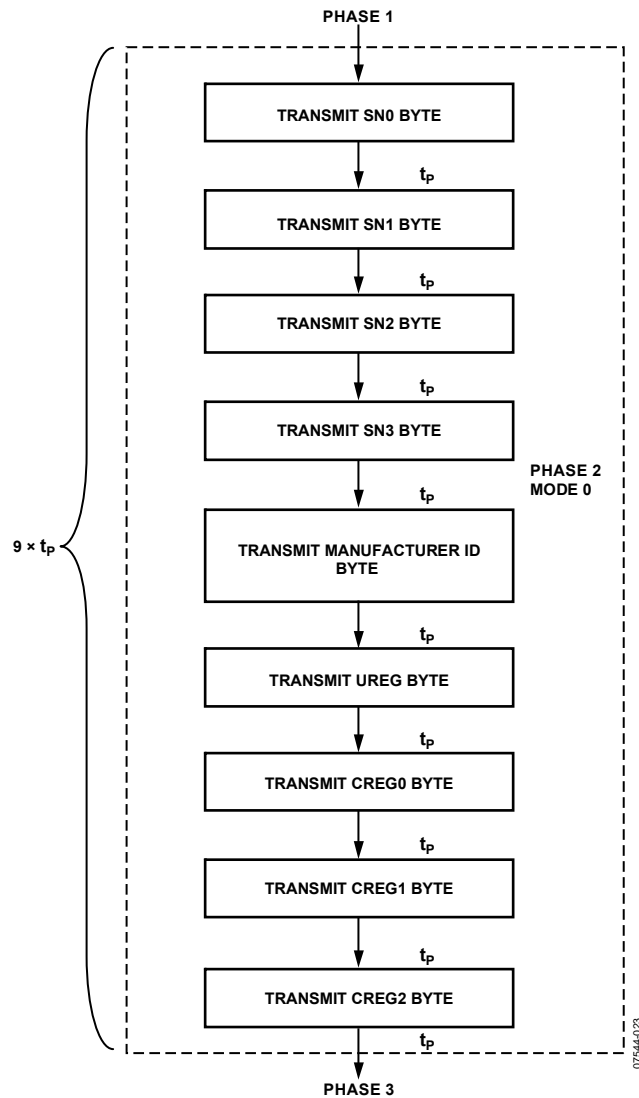

Figure 23. Phase 2 Mode 0 State Machine

Table 26. Mode 0 Serial Number and Configuration Data Byte Sequence

Byte 8	Byte 7	Byte 6	Byte 5	Byte 4	Byte 3	Byte 2	Byte 1	Byte 0
CREG2	CREG1	CREG0	UREG	Manufacturer ID	SN3	SN2	SN1	SN0

Table 27. Mode 0 Manufacturer ID Byte

MSB							LSB
SNPRG	SNPAR	REV2	REV1	REV0	MFGID2	MFGID1	MFGID0

**Table 28. Mode 0 Manufacturer ID Byte Codes**

Manufacturer ID Byte Field	Code (Binary)	Comments
MFGID2 MFGID2 MFGID0	101b	Analog Devices identification code
REV2 REV1 REV0	000b	Die revision code

**Mode 1**

When Phase 2 Mode 1 is selected, only the range data is transmitted during Phase 2. The total number of messages transmitted during Phase 2 Mode 1 is 480.

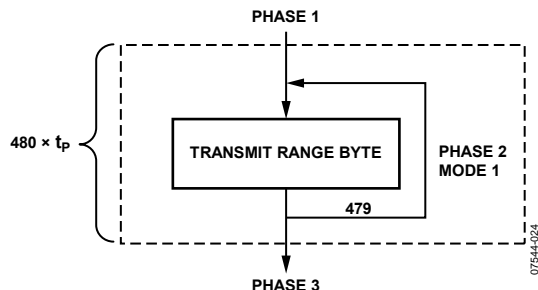

Figure 24. Phase 2 Mode 1 State Machine

A configuration error is flagged when Phase 2 Mode 1 is selected with a range code selection that sets a range other than one of the ranges listed in Table 29. In this case, the error state is entered immediately instead of entering Phase 1. See Table 39 for the error coding. When both Phase 2 Mode 1 and the 10-bit data mode are selected, all range data is transmitted with two zero value LSBs appended (that is, left-justified data), as shown in Table 24. Note that, when Mode 1 is selected with the state vector enabled and auto-zero is not enabled, the full range sensor data coding is used (see the Data Frame Transmission Format section).

Therefore, the positive and negative full-scale ends of the sensor data range overlap with the range and error codes. The state vector distinguishes between the types of transmitted data. The state vector identifies the range data as device data (state vector = 001b) and error codes as status/error data (state vector = 110b). Normal operation sensor data has a state vector of 000b (see Table 19 for details).

**Table 29. Phase 2 Mode 1 Range Data Coding**

8-Bit Data		10-Bit Data		State Vector Code	Description
Decimal	Hex	Decimal	Hex		
-122	0x86	-488	0x218	001b	±250 g measurement range
-125	0x83	-500	0x20C	001b	±50 g measurement range
-128	0x80	-512	0x200	001b	±100 g measurement range

## Mode 2

### Device Data

When Mode 2 is selected, the device data that is transmitted consists of the UREG byte, four configuration register bytes (see Figure 26), and the 4-byte serial number. The data is transmitted one bit per message. Each message represents either a Logic 0 or a Logic 1. The code, 0x7A (+122d), represents a Logic 0 and the code, 0x79 (+121d), represents a Logic 1 in 8-bit data mode. See Table 30 for both 8-bit and 10-bit data coding. The delimiter code depends on the range setting in the configuration registers. The delimiter byte used for each range setting is listed in Table 31. The data is transmitted in the following sequence and as shown in Figure 25. The total number of messages transmitted during Mode 2 Phase 2 is 480.

1. Transmit delimiter code 64 times.
2. Transmit 32 messages of serial number data (32 bits of information, one bit per message).
3. Transmit 12 messages of user bits (12 bits of information, one bit per message). See Table 32.
4. Transmit delimiter code eight times.
5. Repeat Step 2 through Step 4 seven times.

### User Bits and User Register (UREG)

The user bits (U11 to U0) information transmitted during Phase 2 Mode 2 maps into the user and configuration register data stored in the OTP memory of the ADXL180. This includes the 8-bits in the UREG. The mapping is shown in Table 32. See the Configuration Specification section for information about the definition and function of the user and configuration registers data bits.

### 10-Bit Data and Mode 2

During Phase 2 when both Mode 2 and the 10-bit data mode are selected, all device data messages are transmitted with two zero-value LSBs appended (that is, left-justified data). Note that, when Mode 2 is selected with the state vector enabled and the auto-zero is not enabled, the full range sensor data coding is

used (see the Data Frame Transmission Format section). Therefore, the positive and negative full-scale ends of the sensor data range overlap with the device data and status/error codes. The state vector distinguishes between the types of transmitted data. The state vector identifies the device data (state vector = 001b) and the status/error codes (state vector = 110b). Normal operation sensor data has a state vector of 000b. See Table 19 and Table 16.

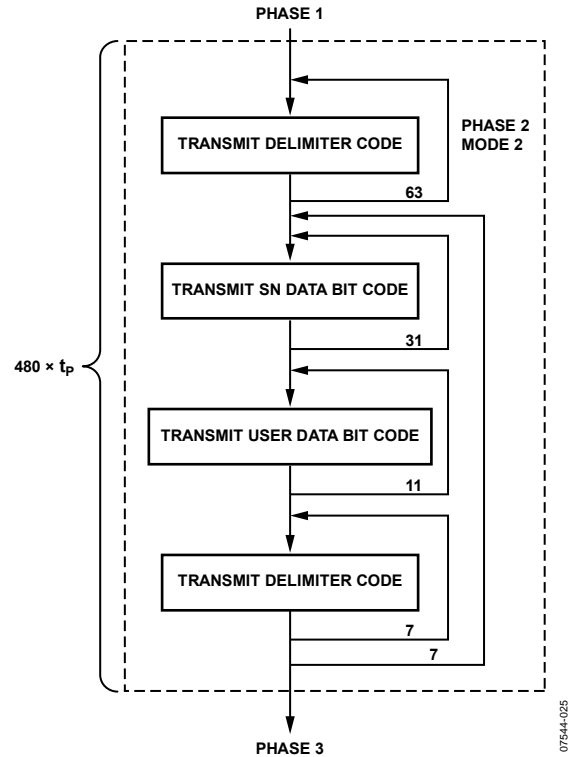

Figure 25. Phase 2 Mode 2 State Machine



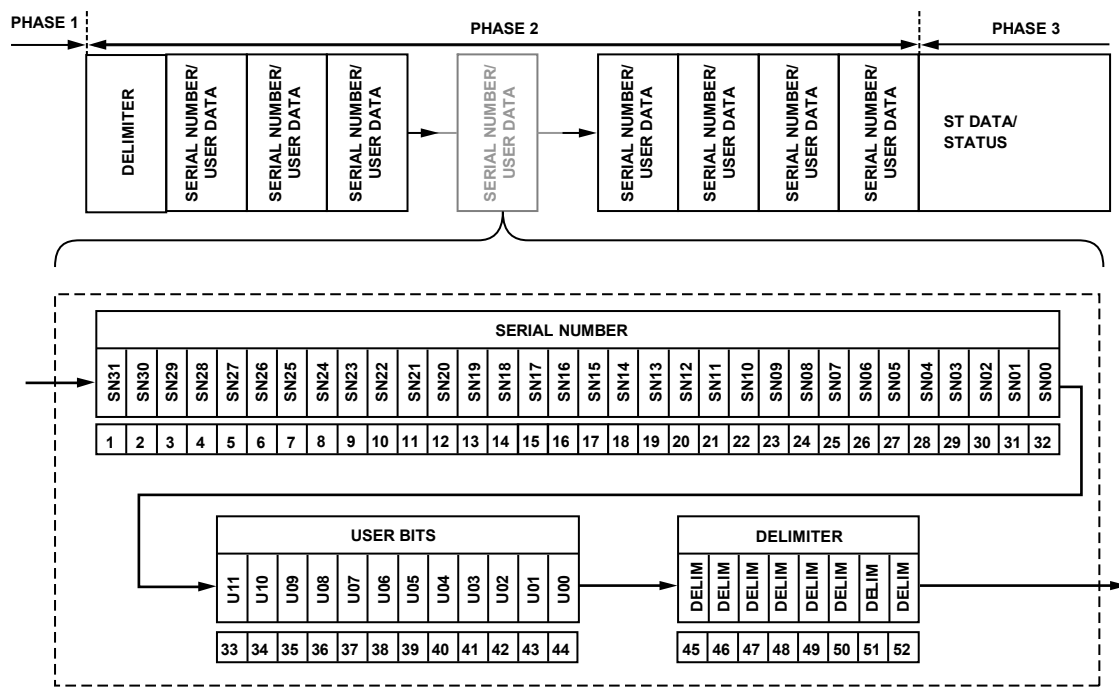

Figure 26. Phase 2 Mode 2 Device Data Transmission

07544-026

Table 30. Phase 2 Mode 2 Sensor and Device Data Coding

8-Bit Data		10-Bit Data		Data Type	Description
Decimal	Hex	Decimal	Hex		
+127	0x7F	+508	0x1FC	Undefined	Unused
+126	0x7E	+504	0x1F8	Undefined	Unused
+125	0x7D	+500	0x1F4	Error code	Device error
+124	0x7C	+496	0x1F0	Undefined	Unused
+123	0x7B	+492	0x1EC	Undefined	Device OK
+122	0x7A	+488	0x1E8	Logic 0	Device data : Logic 0
+121	0x79	+484	0x1E4	Logic 1	Device data : Logic 1
+120	0x78	+480	0x1E0	Undefined	Unused
+119	0x77	+476	0x1DC	Undefined	Unused
+118	0x76	+472	0x1D8	Undefined	Unused
+117	0x75	+468	0x1D4	Undefined	Unused
+116	0x74	+464	0x1D0	Acceleration data	Most positive (+FS) acceleration value
+115	0x73	+460	0x1CC	Acceleration data	
...	...	...	...	...	...
0	0x00	0	0x 000	Acceleration data	Zero (0) acceleration value
...	...	...	...	...	...
-115	0x8D	-460	0x234	Acceleration data	Most negative (-FS) acceleration value
-116	0x8C	-464	0x230	Acceleration data	
-117	0x8B	-468	0x22C	Undefined	Unused
-118	0x8A	-472	0x228	Undefined	Unused
-119	0x89	-476	0x224	Undefined	Unused
-120	0x88	-480	0x220	Undefined	Unused
-121	0x87	-484	0x21C	Undefined	Unused
-122	0x86	-488	0x218	Status code	±250 g measurement range
-123	0x85	-492	0x214	Undefined	Unused
-124	0x84	-496	0x210	Undefined	Unused
-125	0x83	-500	0x20C	Status code	±50 g measurement range

# ADXL180

8-Bit Data		10-Bit Data		Data Type	Description
Decimal	Hex	Decimal	Hex		
-126	0x82	-504	0x208	Undefined	Unused
-127	0x81	-508	0x204	Undefined	Unused
-128	0x80	-512	0x200	Status code	±100 g measurement range

Table 31. Phase 2 Mode 2 Delimiter Coding

Range	State Vector Code	8-Bit Data		10-Bit Data	
		Decimal	Hex	Decimal	Hex
50 g	001b	-125	0x83	-500	0x20C
100 g	001b	-128	0x80	-512	0x200
150 g	001b	-125	0x83	-500	0x20C
200 g	001b	-125	0x83	-500	0x20C
250 g	001b	-122	0x86	-488	0x218
350 g	001b	-125	0x83	-500	0x20C
500 g	001b	-125	0x83	-500	0x20C

**Table 32. Phase 2 Mode 2 User Bit Mapping**

User Bit	Device Data Bit Name
U11	SYEN
U10	RG2
U09	RG1
U08	RG0
U07	UD7
U06	UD6
U05	UD5
U04	UD4
U03	UD3
U02	UD2
U01	UD1
U00	UD0

### Mode 3

#### Device Data

In Phase 2 Mode 3, the 10-bit data codes, -512 (0x200) to -481 (0x21F), are used to transmit the device data. The data coding is shown in Table 34 and in Figure 27. One 4-bit nybble of the device data (encoded as one of 16 nybble codes) is transmitted in each 10-bit message. The number of the data nybble is identified by the preceding nybble number (NN) code as detailed in Table 33. This allows a total of  $(16 \times 4) = 64$  unique bits of device data to be transmitted during Phase 2. Each message is repeated

32 times for each nybble number. The specific meaning of each data nybble is defined in Table 33. The total number of messages transmitted during Phase 2 in Mode 3 is  $(32 \times 16) = 512$ .

#### User Register (UREG)

The User Register UREG[7:0], in Mode 3 transmit during Nybble 7 (UREG[7:4]) and Nybble 8 (UREG[3:0]).

#### Use with State Vector Enabled

When Mode 3 is selected with the state vector enabled and the auto-zero not enabled, the full range sensor data coding is used (see the Data Frame Transmission Format section). Therefore, the positive and negative full-scale ends of the sensor data range overlap with the device data and status data codes. The state vector distinguishes between the types of transmitted data. The state vector identifies the device data (state vector = 001b) and status codes as status/error data (state vector = 110b). Normal operation sensor data has a state vector of 000b (see Table 19).

#### Illegal Configuration: Mode 3 and 8-Bit Data

A configuration error is flagged if Phase 2 Mode 3 is selected and the configuration register is programmed to select the 8-bit data mode. In this case, the error state is entered immediately instead of Phase 1. See the Error Detection section for more information.

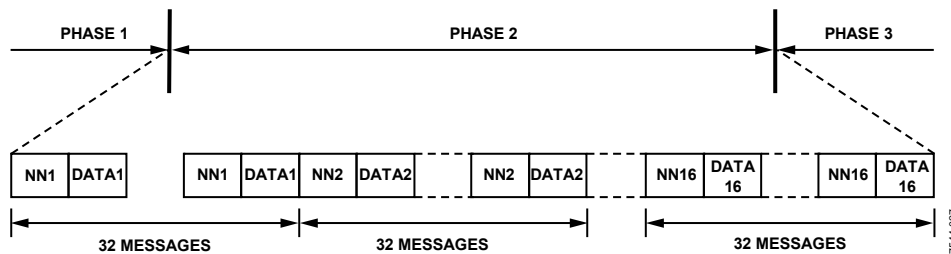

Figure 27. Mode 3 Device Data Transmission

**Table 33. Phase 2 Mode 3 Device Data Mapping**

Device Data Nybble No.	Definition		Binary Code	Nybble Sent
1 <sup>1</sup>	Protocol ID		001	0011
2	Number of nybbles sent	16	10000	0000
3	Manufacturer	Analog Devices	101	1010
4	Sensor type	Accelerometer	00001	0001
5	Sensor range <sup>2</sup>	100 g	0000	0000
		50 g	0001	0001
		200 g	0010	0010
		Other	0011	0011
6	BDE and RS	RS = 0, BDE = 0	0000	0000
		RS = 0, BDE = 1	0001	0001
		RS = 1, BDE = 0	0010	0010
		RS = 1, BDE = 1	0011	0011
7	User data (UD Bits[7:4])	0 to 255	XXXX <sup>3</sup>	XXXX
8	User data (UD Bits[3:0])	0 to 255	XXXX	XXXX
9	Serial number (Bits[31:28])		XXXX	XXXX
10	Serial number (Bits[27:24])		XXXX	XXXX

# ADXL180

Device Data Nybble No.	Definition	Binary Code	Nybble Sent
11	Serial number (Bits[23:20])	XXXX	XXXX
12	Serial number (Bits[19:16])	XXXX	XXXX
13	Serial number (Bits[15:12])	XXXX	XXXX
14	Serial number (Bits[11:8])	XXXX	XXXX
15	Serial number (Bits[7:4])	XXXX	XXXX
16	Serial number (Bits[3:0])	XXXX	XXXX

<sup>1</sup> Data Nybble 1 is transmitted first.

<sup>2</sup> If the configuration register settings have configured the ADXL180 for a range other than 50 g, 100 g, or 200 g, the other code (0011b) is sent. In these cases, the UD bits can be used to indicate the actual range.

<sup>3</sup> X indicates that the data is device dependent.

**Table 34. Phase 2 Mode 3 Sensor and Device Data Coding**

Decimal	Hex	Data Type	Description
511	0x1FF	Undefined	Unused
...	...	Undefined	Unused
501	0x1F5	Undefined	Unused
500	0x1F4	Status	Device Error
499	0x1F3	Undefined	Unused
...	...	Undefined	Unused
488	0x1E8	Undefined	Unused
487	0x1E7	Status	Device OK
486	0x1E6	Undefined	Unused
...	...	Undefined	Unused
465	0x1D1	Undefined	Unused
464	0x1D0	Acceleration Data	Most positive (+FS) acceleration value
...	...	Acceleration Data	...
0	0x000	Acceleration Data	Zero (0) acceleration value
...	...	Acceleration Data	...
-464	0x230	Acceleration Data	Most negative (-FS) acceleration value
-465	0x22F	Undefined	Unused
...	...	Undefined	Unused
-480	0x220	Undefined	Unused
-481	0x21F	Data Nybble	Device Data 1111
-482	0x21E	Data Nybble	Device Data 1110
-483	0x21D	Data Nybble	Device Data 1101
-484	0x21C	Data Nybble	Device Data 1100
-485	0x21B	Data Nybble	Device Data 1011
-486	0x21A	Data Nybble	Device Data 1010
-487	0x219	Data Nybble	Device Data 1001
-488	0x218	Data Nybble	Device Data 1000
-489	0x217	Data Nybble	Device Data 0111
-490	0x216	Data Nybble	Device Data 0110
-491	0x215	Data Nybble	Device Data 0101
-492	0x214	Data Nybble	Device Data 0100
-493	0x213	Data Nybble	Device Data 0011
-494	0x212	Data Nybble	Device Data 0010
-495	0x211	Data Nybble	Device Data 0001
-496	0x210	Data Nybble	Device Data 0000

Decimal	Hex	Data Type	Description
-497	0x20F	Nybble Number	Device Data Nybble 16
-498	0x20E	Nybble Number	Device Data Nybble 15
-499	0x20D	Nybble Number	Device Data Nybble 14
-500	0x20C	Nybble Number	Device Data Nybble 13
-501	0x20B	Nybble Number	Device Data Nybble 12
-502	0x20A	Nybble Number	Device Data Nybble 11
-503	0x209	Nybble Number	Device Data Nybble 10
-504	0x208	Nybble Number	Device Data Nybble 9
-505	0x207	Nybble Number	Device Data Nybble 8
-506	0x206	Nybble Number	Device Data Nybble 7
-507	0x205	Nybble Number	Device Data Nybble 6
-508	0x204	Nybble Number	Device Data Nybble 5
-509	0x203	Nybble Number	Device Data Nybble 4
-510	0x202	Nybble Number	Device Data Nybble 3
-511	0x201	Nybble Number	Device Data Nybble 2
-512	0x00	Nybble Number	Device Data Nybble 1

### PHASE 3: SELF-TEST DIAGNOSTIC

The ADXL180 has two self-test modes, internal and external. In both modes the ADXL180 applies an internally generated electrostatic force to the sensor, simulating an acceleration force. This force causes the sensor proof-mass to displace. This displacement is transduced by the sensor interface electronics and passed through the signal chain to the ADC. When in external self-test mode, the ADXL180 transmits sensor data while activating the self-test signal several times. When in internal self-test mode, the ADXL180 transmits data dependent on the setting of the Phase 2 Mode select bits. While doing so, the ADXL180 activates the self-test signal several times. It then examines the results and either continues the start-up initialization sequence or reports an error. The detailed operation of the two self-test modes is described in the following sections.

#### Concept of Self-Test

The fixed plates in the forcing cells are normally kept at the same potential as that of the movable frame. When self-test is activated, the voltage between the fixed plates and the moving plates in the forcing cells is changed. This creates an attractive electrostatic force, which causes the frame to move toward one set of fixed plates. The entire signal channel is active; therefore, the sensor displacement causes a signal change at the output of the ADC.

#### Internal and External Self-Test Option

There are two selectable modes of operation for self-test. The self-test modes are internal and external. The self-test mode is

toggled by selecting or deselecting the STI configuration bit, as shown in Table 35.

**Table 35. Self Test Internal (STI) Options**

STI	Definition
0	External self-test. User must monitor self-test data to verify proper operation. Device does not monitor its own response to the self-test stimulus. (Default.)
1	Internal self-test. The device internally monitors self-test data to determine proper operation.

#### External Self-Test

The external self-test mode applies an electrostatic force to the sensor (simulating an acceleration force) and transmits the sensor data to the control module. This allows the control module to measure the subsequent change in the sensor output value. The signal path low-pass filter of the ADXL180 has a slower response time than the rise time of the internal self-test control (STC) signal. Therefore, the sensor data transmitted during the external self-test sequence follows the rise and fall times of the low pass filter in response to the internal STC signal. The state vector (if enabled) provides the relative timing information indicating when the internal STC signal is applied to the sensor.

The STC signal activates six times during the self-test state of the ADXL180 (see Figure 28). During external self-test, an average of the zero self-test value is computed and subsequently used to provide an initial offset correction value for the auto-zero function. See the Phase 4: Auto-Zero Initialization section for more information.

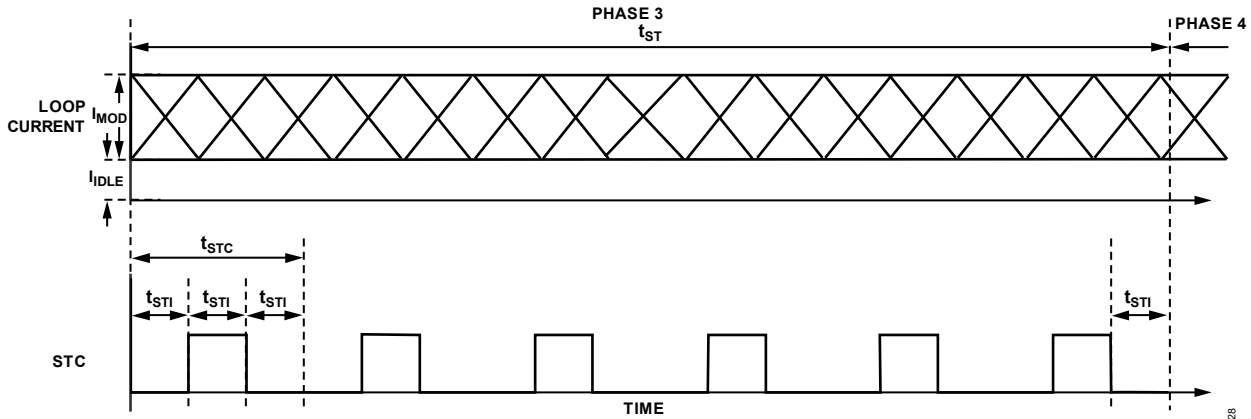

Figure 28. External Self-Test Control Timing

### Internal Self-Test

The internal mode self-test applies an electrostatic force to the sensor (simulating an acceleration force) and measures the change in the sensor output value. A self-test cycle ( $t_{STC}$ ) constitutes one activation and deactivation of the self-test force. A self-test cycle is considered passed if the change in the sensor output value falls within the expected minimum and maximum self-test response levels. The internal self-test (Phase 3) is exited and Phase 4 is entered upon completing the second of any two successful self-test cycles.

A self-test cycle is considered failed if the change in the sensor output value is not within the expected levels. The self-test cycle is then repeated. The self-test cycle is run a maximum of six times. The internal self-test (Phase 3) is exited and the error state entered if fewer than two of the six self-test cycles pass. Once the error state is entered, the self-test error code is transmitted until the device is reset.

The internal self-test sequence is as follows:

1. Wait 32 consecutive ADC samples.
2. Average 64 consecutive ADC samples ( $V_{STZ1}$ ).
3. Enable self-test voltage.
4. Wait 32 consecutive ADC samples.
5. Average 64 consecutive ADC samples ( $V_{STP}$ ).
6. Disable self-test voltage.
7. Wait 32 consecutive ADC samples.
8. Average 64 consecutive ADC samples ( $V_{STZ2}$ ).
9. Compare measured values.
  - a. Compare ( $V_{STZ1}$ ) to specified minimum and maximum offset tolerance.
  - b. Compare ( $V_{STZ2}$ ) to specified minimum and maximum offset tolerance.

- c. Calculate difference ( $V_{STP} - V_{STZ1}$ ) and compare to specified minimum and maximum difference.
  - d. Calculate the absolute difference ( $V_{STZ1} - V_{STZ2}$ ) and compare to the maximum value.
  - e. If delta is less than or equal to four counts (10 bits), then the self-test is a pass.
  - f. If delta is greater than or equal to five counts (10 bits), then the self-test is a fail.
10. If any measurements in Step 9 fail to achieve the defined limits, then repeat Step 1 through Step 9. Repeat a maximum of five times.
  11. If fewer than two out of the six self-test cycles pass, an internal self-test error flag is set. The error state is then entered. The self-test error code is sent until the device is reset.
  12. Phase 4 is entered upon completing the second of any two successful self-test cycles.

### Influence of MD Selections On Transmitted Self-Test Data

Table 36. Phase 3 Data Transmitted During Internal Self-Test

MD1	MD0	Data
0	0	Device OK
0	1	Range
1	0	Delimiter
1	1	Device OK

When the internal self-test mode is selected, the type of data transmitted during Phase 3 is dependent on the setting of the Phase 2 mode select bits (MD1 and MD0). See Table 36 and Table 39 for the Device OK code. See the Phase 2: Device Data Transmission section for specifics of the delimiter and range codes.

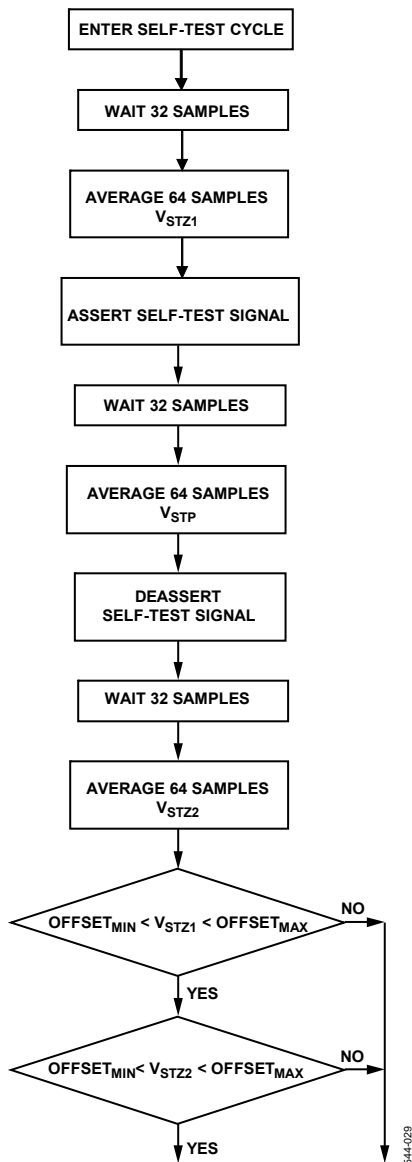

Figure 29. First Half Is Joined to Second Half of ST Chain

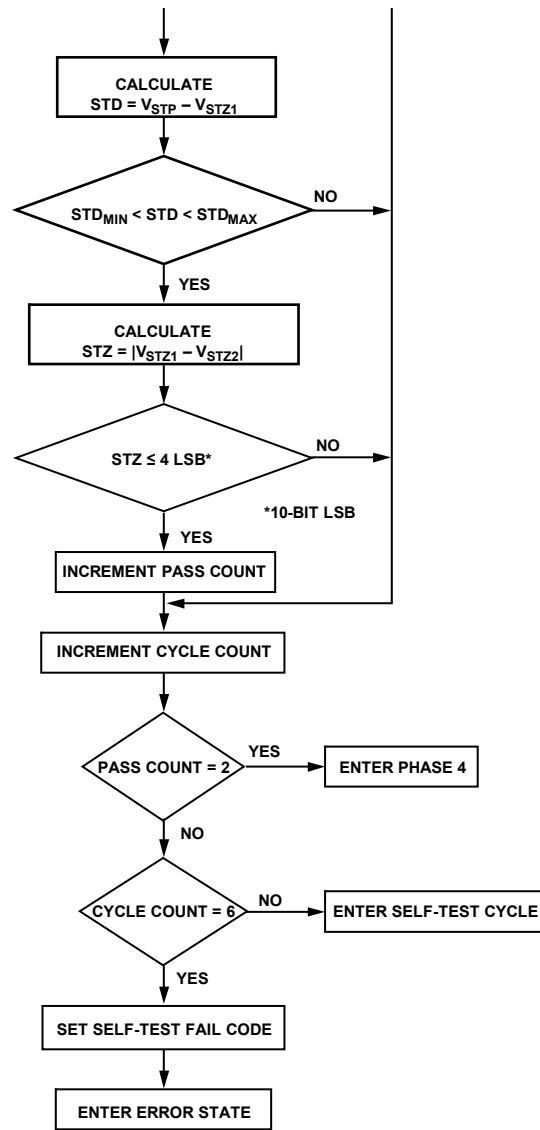

Figure 30. Internal Self-Test State Machine

## PHASE 4: AUTO-ZERO INITIALIZATION

If auto-zero is not enabled, upon entering Phase 4, the ADXL180 immediately passes from Phase 4 to Phase 5.

### **Fast Auto-Zero Mode**

If auto-zero is enabled, the fast auto-zero routine begins upon entering Phase 4. The last offset average measurement (VSTZ2) of Phase 3 is used as a starting value for the fast auto-zero routine. This occurs whether internal or external self-test has been selected. See the External Self-Test section. The auto-zero function is described in the Auto-Zero Operation section.

The ADXL180 transmits the offset corrected sensor data every 228  $\mu\text{s}$  in asynchronous mode during Phase 4. When in synchronous mode, the ADXL180 transmits the offset corrected sensor data after receiving a valid synchronization pulse during Phase 4. The number of sensor values sent during Phase 4 is 65,535. Therefore, in asynchronous mode, the Phase 4 time period is nominally 15 seconds long, during which time the device fully responds to acceleration input.

### **Error Reporting**

If an error is detected during Phase 4, (for example, offset out of range, OTP parity error, and so forth), the appropriate error code is set and the error state is entered. The error code is transmitted until the device is reset. See Table 39 for error code

specifics. No acceleration data is transmitted when the ADXL180 is in the error state.

## PHASE 5: NORMAL OPERATION

If auto-zero is not enabled, upon entering Phase 5, the ADXL180 transmits the measured (raw) acceleration signal every 228  $\mu\text{s}$  (in asynchronous mode) until power down. In synchronous mode, raw data is transmitted in response to every synchronization pulse until power down.

### **Slow Auto-Zero**

If auto-zero is enabled, the slow auto-zero routine begins upon entering Phase 5. The ADXL180 transmits the offset corrected acceleration signal every 228  $\mu\text{s}$  (in asynchronous mode) until power down. In synchronous mode, offset corrected data is transmitted in response to every synchronization pulse until power down. The auto-zero function is described in the Auto-Zero Operation section.

### **Error Reporting**

Although the auto-zero routine continually corrects for offset drift, if an error is detected during Phase 5, (for example, offset out of range, OTP parity error, and so forth), the appropriate error code is set and the error state is entered. The error code is transmitted until the device is reset. See Table 39 for error code specifics. No acceleration data is transmitted when the ADXL180 is in the error state.



## SIGNAL RANGE AND FILTERING

### TRANSFER FUNCTION OVERVIEW

The three-pole, low-pass Bessel filter has a selectable  $-3$  dB corner ( $f_{LP}$ ). The corner can be set to 100 Hz, 200 Hz, 400 Hz, or 800 Hz by programming the filter corner (FC) bits in the configuration registers. In the pass band between  $f_{HP}$  and  $f_{LP}$ , the response of the ADXL180 is flat with the nominal scale factor defined by the settings of the range (RG) bits in the configuration registers (see Figure 31). The auto-zero function creates a first-order high-pass filter with a  $-3$  dB corner at  $f_{LP}$ . Note that the output of this filter is slew rate limited. The auto-zero function can be disabled by setting the appropriate bit in the configuration registers. See the Specifications section for more information.

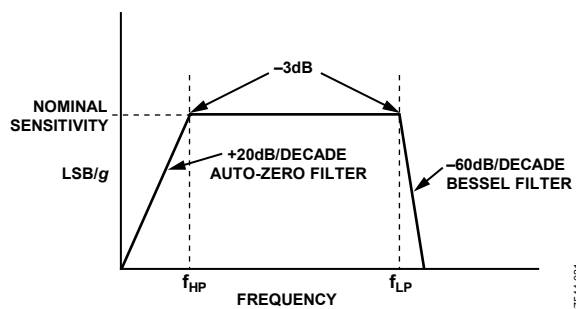

Figure 31. Bode Plot of ADXL180 Transfer Function

### RANGE

Table 37. RG[2:0] Sensor Range Select Codes

RG2	RG1	RG0	Range
0	0	0	$\pm 50 g$
0	0	1	$\pm 100 g$
0	1	0	$\pm 250 g$
0	1	1	$\pm 150 g$
1	0	0	$\pm 200 g$
1	0	1	$\pm 350 g$
1	1	0	$\pm 500 g$
1	1	1	Not used

The ADXL180 is configurable into the  $g$ -ranges shown in Table 37. Adjusting the device  $g$ -range alters the  $g/LSB$  scale factor. Selecting the 50  $g$  range offers increased data resolution of 0.125  $g/LSB$ ; however, input signals above 50  $g$  appear clipped on the output of the device. Selecting a higher  $g$ -rating decreases the resolution of data; however, it allows for a wider full-scale range of observable signals.

### THREE-POLE BESSEL FILTER

Table 38. FC Low-Pass Filter Bandwidth Frequency Select Codes

FC1	FC0	$-3$ dB LP Frequency
0	0	400 Hz
0	1	200 Hz
1	0	100 Hz
1	1	800 Hz

By configuring the FC1 and FC0 bits as shown in Table 38, the output filter on the ADXL 180 can be set. This adjusts the  $-3$  dB frequency of the output filter to the desired bandwidth. The ADXL180 low-pass filter is a third-order, low-pass Bessel filter with a  $-60$  dB per decade roll-off. See the Specifications table for more information on the tolerances of the low-pass filter bandwidth.

### AUTO-ZERO OPERATION

The auto-zero function is enabled by setting the appropriate bit in the configuration registers, see Table 44. This function helps reduce slow offset drifts due to aging, temperature, and so forth. The acceleration signal offset is determined by passing the acceleration signal through a one-pole digital low-pass filter. The output of this filter is then slew rate limited. The slew rate limited offset value is then subtracted from the acceleration data. This forms a slew rate limited high-pass filter as shown in Figure 32.

If auto-zero mode is enabled, a fast offset compensation is performed during start up of Phase 4 (fast auto-zero mode). The filter output is set to the last zero reading average performed by the self-test (Phase 3). The  $-3$  dB frequency of the digital low-pass filter is approximately 0.08 Hz, and the slew rate limiter output (and therefore the offset correction) is updated every 0.5 seconds. The fast update mode (Phase 4) is 15 seconds long in asynchronous mode and  $65,535 \times t_{ps}$  in synchronous mode (see the Phase 4: Auto-Zero Initialization section).

If auto-zero mode is enabled, an offset compensation is performed during normal operation (Phase 5). This offset compensation is performed at a slower rate than during the auto-zero initialization (Phase 4). The  $-3$  dB frequency of the digital low-pass filter is approximately 0.01 Hz and the slew rate limiter output (and therefore the offset correction) is updated every five seconds. The slow update mode persists until power down. See the Phase 5: Normal Operation section.

The range of the offset corrected output is reduced compared to when the auto-zero is disabled. This is the function of the limiter block in Figure 32. This range reduction is shown in Table 16 and Table 17.

# ADXL180

## Offset Drift Monitoring

Cumulative offset drift is monitored during the normal operation of the ADXL180. Offset drift monitoring occurs at the same rate as auto-zero but runs independent of whether auto-zero is enabled or disabled. An offset error is flagged if the offset correction exceeds the maximum specified value. The

appropriate error code is sent in the next data frame transmitted to the control module (see the Offset Error/Offset Drift Monitoring section). This message is sent continuously until power to the ADXL180 is removed. The error status clears on the next power-on-reset.

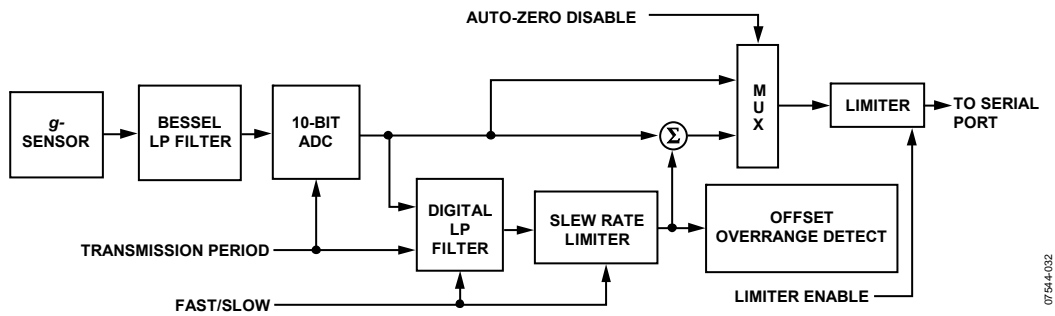

## ERROR DETECTION

### OVERVIEW

The ADXL180 monitors its internal operation and reports errors. The error reporting codes differ depending on whether the state vector has been enabled. Table 39 describes the errors and the specific codes transmitted in various configurations. The state vector allows the ADXL180 to report specific errors if enabled. If the state vector is not enabled, a single error code is sent regardless of the type of error. The error code is transmitted every 228  $\mu$ s in asynchronous mode until power down. The error code is transmitted in response to every synchronization pulse in synchronous mode until power down.

### PARITY ERROR DUE TO COMMUNICATIONS PROTOCOL CONFIGURATION BIT ERROR

As shown in Table 39, an error code is generated if the parity of the ADXL180 device OTP memory is incorrect. However, if this error is due to a parity error in one of the ERC, SVD, DAT, or MAN bits that govern the format of the transmitted message, the error code is transmitted in an alternate data format. Receive system designs that recognize repeated message transmissions, wrong data lengths, and incorrect Manchester encoding help to detect more easily that an error code is being set.

**Table 39. Status/Error Coding**

Error	State Vector Enabled				State Vector Disabled				Error Reporting Active in Phases
	8-Bit Data Mode		10-Bit Data Mode		8-Bit Data Mode		10-Bit Data Mode		
Configuration Error	0x7F	127d	0x1F9	505d	0x7D	125d	0x1F4	500d	2
Offset Error	0x7E	126d	0x1F8	504d	0x7D	125d	0x1F4	500d	5
Self-Test Error	0x7D	125d	0x1F7	503d	0x7D	125d	0x1F4	500d	4, 5 <sup>1</sup>
OTP Parity Error	0x7C	124d	0x1F6	502d	0x7D	125d	0x1F4	500d	4, 5
Device OK	0x7B	123d	0x1E7	487d	0x7B	123d	0x1E7	487d	3
Device Not OK (NOK)	0x7A	122d	0x1F4	500d	0x7D	125d	0x1F4	500d	3, 4, 5

<sup>1</sup> A self-test error reported during Phase 5 indicates a failure of the internal self-test circuit, not a sensor self-test error.

## SELF-TEST ERROR

In the ADXL180, self-test is automatically run during Phase 3. If the internal self-test mode is selected, then the device enters into the self-test routine as detailed in Figure 29 and Figure 30. The device reports a failure during Phase 3 if it does not detect two successful self-test pulses. When external self-test is enabled, the device enters into the self-test routine as detailed in Figure 29 and Figure 30; however, it reports all six self-test pulses to the control module. The control module is responsible for designation of a device failure.

## OFFSET ERROR/OFFSET DRIFT MONITORING

During Phase 3, an offset calculation is performed by averaging the offset value with self-test deasserted (see Figure 29 for more details). If this value is outside of the datasheet specifications, then an error is reported at the start of Phase 5. Additionally,

the ADXL180 continuously monitors long term offset drift. If the long-term offset correction exceeds the maximum specified value, then an offset error is reported. This error is reported independent of whether or not the auto-zero functionality has been enabled.

## VOLTAGE REGULATOR MONITOR RESET OPERATION

The control module can reset the ADXL180 by lowering the bus supply voltage to cause a power-fail reset. Figure 33 shows that, for both the undervoltage and overvoltage trip thresholds, there is a nominal 120 mV hysteresis before the voltage regulator returns to within specification. No data transmission occurs while the ADXL180 is in the reset state. The bus current is held at the idle level during reset.

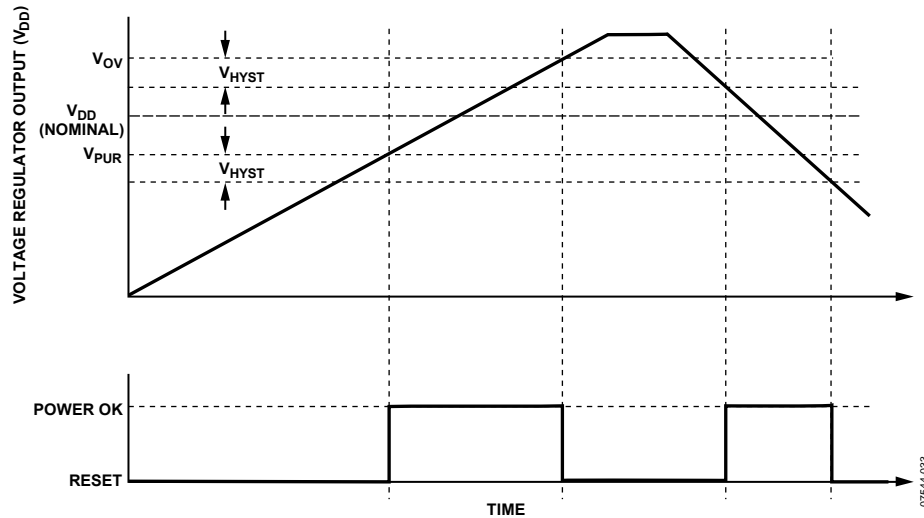

Figure 33. Voltage Regulator Monitor Reset Functionality

## TEST AND DIAGNOSTIC TOOLS

### V<sub>SCI</sub> SIGNAL CHAIN INPUT TEST PIN

The V<sub>SCI</sub> signal chain input test pin allows the excitation of the signal chain from the input of the sensor interface circuitry (sensor amplifier) through to the output of the current mode serial port. The function of this pin becomes active after the pin input voltage exceeds the level of about 0.8 V. Below this level, the ADXL180 does not respond to the voltage applied to the V<sub>SCI</sub> pin. Above the threshold limit of 0.8 V, the voltage signal at the V<sub>SCI</sub> pin is applied to the sensor interface circuitry in parallel with the sensor signal.

The applied signal is zero when the input signal is equal to the common-mode potential of the sensor interface circuitry (~V<sub>DD</sub>/2 V), see Figure 34. The V<sub>SCI</sub> input scaling for all ranges is typically about 640 μV/g. The scaling of the V<sub>SCI</sub> input voltage to the ADC code output is dependent on the range setting of the part.

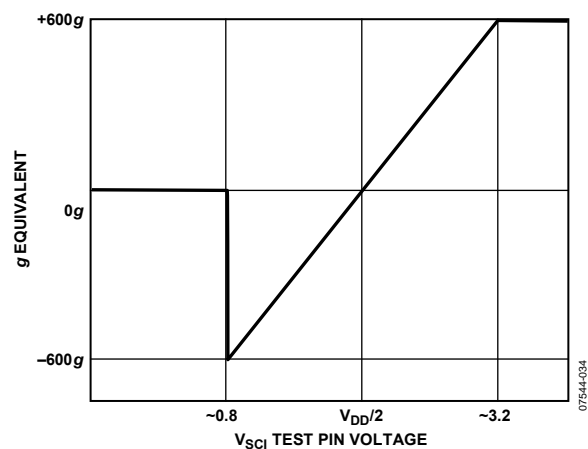

Figure 34. V<sub>SCI</sub> Signal Chain Input Test Pin Transfer Function

### V<sub>SCO</sub> ANALOG SIGNAL CHAIN OUTPUT TEST PIN

The V<sub>SCO</sub> analog signal chain output test pin provides access to the sensor signal chain analog output voltage at the output of the Bessel filter. This signal is filtered and ranged as defined by the configuration register settings. It is before the digital auto-zero function in the signal chain. Therefore, it is not auto-zeroed. The configuration register SCOE bit must be set to 1 to enable this output. The signal output resistance is typically 50 Ω. Connect this output to a high impedance input only.

Table 40. SCOE V<sub>SCO</sub> Signal Chain Output Enable

SCOE	Definition
0	V <sub>SCO</sub> output disabled. (Default.)
1	V <sub>SCO</sub> output enabled. Analog output prior to ADC conversion is present on V <sub>SCO</sub> pin. Connect V <sub>SCO</sub> to high impedance input, or data or sensor data may be adversely affected.

Table 41. Typical V<sub>SCO</sub> Sensitivity Per g-Range

g-Range	Sensitivity
50 g	32.8 mV/g
100 g	16.4 mV/g
150 g	10.8 mV/g
200 g	8.2 mV/g
250 g	6.56 mV/g
350 g	4.69 mV/g
500 g	3.28 mV/g

## CONFIGURATION SPECIFICATION

### OVERVIEW

The ADXL180 configuration mode allows access to the user-programmable nonvolatile configuration registers used to define the function of the device. The configuration mode is entered by writing a 16-bit configuration mode enable key code to the  $V_{BP}$  pin during Phase 1 of the ADXL180 start-up sequence, which begins immediately after power is applied to the ADXL180. The 16-bit configuration mode enable key code is 0x5A5A with no start or parity bits (see Figure 36). The configuration mode key is sent LSB first. Note that the configuration mode key code is 16 bits long and the configuration mode read/write command data frames are 14 bits long. This helps avoid misinterpretation of either by the ADXL180.

All configuration mode data sent to the ADXL180, including the configuration mode enable key code is communicated to

the ADXL180 via voltage modulation of the  $V_{BP}$  pin with respect to the  $V_{BN}$  pin. This signal uses pulse duration modulation to combine the clock and digital data. The clock and data are encoded as shown in Figure 35.

The ADXL180 acknowledges entering the configuration mode by transmitting the contents of the CREG2 register. This register contains the configuration/user data programming bit (CUPRG) status. This allows the user's configuration/test system to determine whether the ADXL180 configuration OTP fuse memory has been programmed without further communication. If the configuration mode is not entered within the Phase 1 initialization time period, the ADXL180 treats the pulses on the  $V_{BP}$  pin as synchronization pulses (in synchronous mode) or ignores them in asynchronous mode.

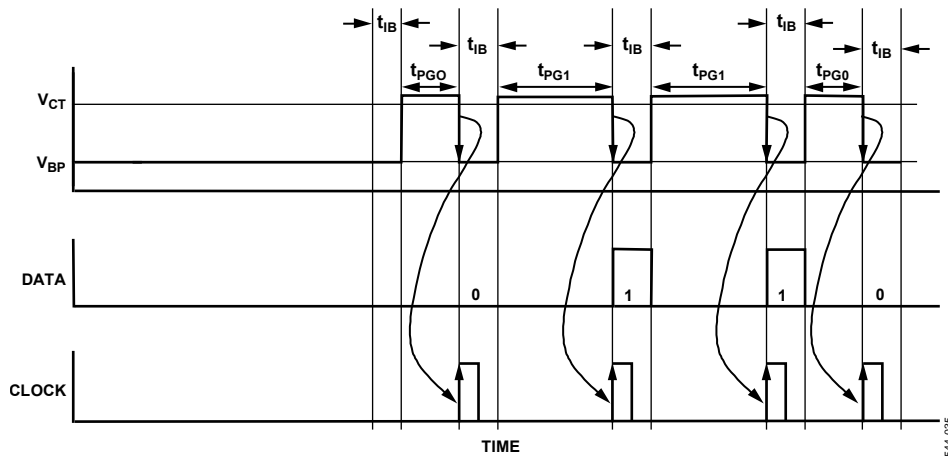

Figure 35. Configuration Mode Receive Pulse Width Data and Clock Encoding

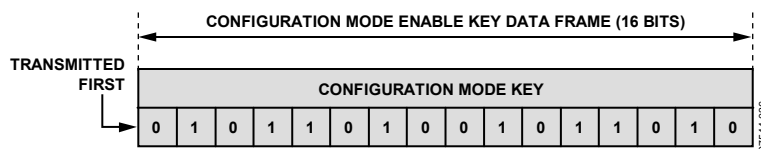

Figure 36. Configuration Mode Enable Key Code Data Frame

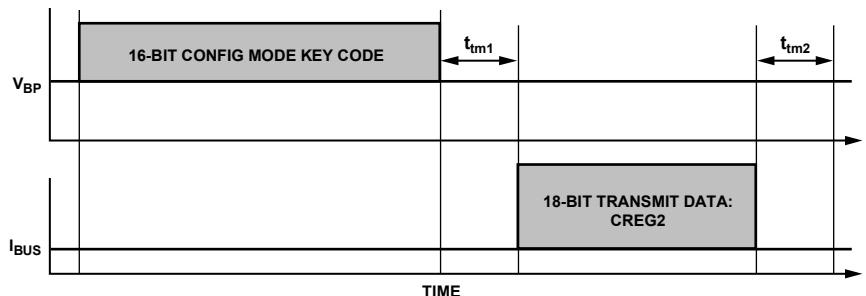

Figure 37. Configuration Mode Entry Key Code Sequence

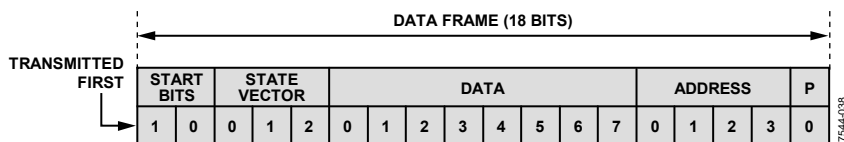

Figure 38. Configuration Mode Transmit Data Frame

## CONFIGURATION MODE TRANSMIT COMMUNICATIONS PROTOCOL

In configuration mode, the ADXL180 transmits the configuration mode register data through the current mode Manchester encoded serial port. The configuration mode protocol is fixed regardless of the actual settings of the configuration registers (RAM or OTP). The transmit communication protocol used by the ADXL180 in configuration mode is

- Manchester-1 data encoding
- Two start bits (10b)
- 4-bit configuration mode register address field
- 8-bit configuration mode register data field
- 3-bit state vector field (101b)
- One parity bit (even)
- Synchronization pulse disabled
- Auto-zero disabled
- Data is transmitted LSB first

This is an 18-bit protocol (including the two start bits). Although similar to the ADIFX protocol, it is different in that parity, and not CRC, is used as the error checking code. This distinguishes configuration mode messages from normal operation messages. Figure 38 shows the configuration mode data frame format.

Table 42 shows the configuration mode transmit data bit mapping. Excluding the two start bits, the word is 16 bits long. Data Bit DB15 (transmitted last) is the parity bit. The configuration mode transmit parity is even. The parity bit is set to either 1 or 0 to make the total number of 1s in the 16-bit word an even number. Data Bits[DB14:DB11] are the four configuration mode register address bits. The following eight data bits, DB10 through DB3, are the eight configuration mode register data bits. The next three bits, DB2 through DB0, are the state vector bits. In the configuration mode, the state vector is 101b. This data frame format is different from the ADIFX format.

# ADXL180

## CONFIGURATION MODE COMMAND (RECEIVE) COMMUNICATIONS PROTOCOL

The 8-bit configuration register data is passed to the ADXL180 with a read/write command bit, a 4-bit configuration register address, and a parity bit as shown in Figure 39. The read/write bit is set to indicate the desired action. A 0 indicates a write

operation and a 1 indicates a read operation. The parity bit is set for even parity. The parity bit should be set to 0 or 1 to make the total number of 1s in the data frame even. The data is transmitted LSB first as shown in Table 42.

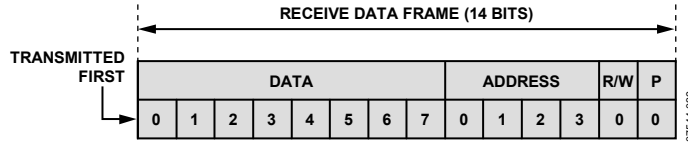

Figure 39. Configuration Mode Command (Receive) Data Frame

Table 42. Configuration Mode Transmit Data Bit Mapping

DB15	DB14	DB13	DB12	DB11	DB10	DB9	DB8	DB7	DB6	DB5	DB4	DB3	DB2	DB1	DB0
Parity	Addr 3	Addr 2	Addr 1	Addr 0	Data Bit 7 (MSB)	Data Bit 6	Data Bit 5	Data Bit 4	Data Bit 3	Data Bit 2	Data Bit 1	Data Bit 0 (LSB)	State Vector 2	State Vector 1	State Vector 0



## CONFIGURATION MODE COMMUNICATIONS HANDSHAKING

Configuration mode communications uses a handshaking protocol. Following the completion of a data write or data read command being written to the ADXL180, a data frame is transmitted from the ADXL180 through the current mode serial port. This forms a handshake acknowledgment with the test system (see Figure 40). The source of the data (RAM or OTP) transmitted in the handshake data frame is dependent on whether the OTP memory has been programmed.

Upon receiving a configuration mode data frame, if a parity error is detected, the ADXL180 returns a handshake data frame with the state vector code set to the status/error state vector code (110b). The 8-bit data field and the 4-bit address field are both set to all 0s.

When the test system sends a data write command, the data that was written to the addressed configuration mode register is then

written to RAM, read back from the RAM, and transmitted to the user's test/configuration system as a handshake. This provides a data integrity check for data write commands. If there is an attempt to write data to a RAM register after the CUPRG bit is set, the data is ignored by the ADXL180 (that is, it has no effect on the device). The data returned by the ADXL180 is the contents of the addressed OTP fuse register. This is the same result as if a data read command had been issued.

When the test/configuration system sends a data read command, the data contained in the data frame is ignored and the data that is contained in the addressed configuration mode register is sent to the test/configuration system in response. The data sent is always read from the RAM registers. If the CUPRG bit has not been set (that is, the OTP fuses are not programmed), the RAM contains the last data written to it by the configuration/test system. When the CUPRG bit is set (that is, the OTP fuses are programmed) the fuse data is loaded into the RAM registers (see Figure 42).

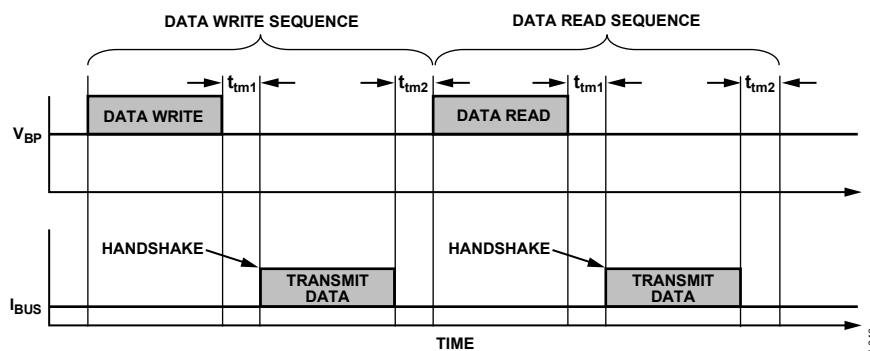

Figure 40. Configuration Mode Write Data and Read Data Sequences

07544-040

## CONFIGURATION AND USER DATA REGISTERS

The configuration and user data registers are the user register, UREG, and the three configuration registers, CREG0, CREG1, and CREG2 (see Table 44). The ADXL180 can be programmed to provide a variety of signal chain characteristics and device operating modes via Configuration Register CREG0, Configuration Register CREG1, and Configuration Register CREG2. The configuration register and user register data can be programmed into nonvolatile OTP memory.

In general, the CREG registers hold data that alters the function of the ADXL180. The data contained in the UREG has no effect on the operation of the ADXL180. The UREG bits are typically used to indicate information such as module housing type and sensing axis. The ADXL180 can be programmed to transmit the UREG bits as part of the device data during power-up Phase 2, depending on the Phase 2 mode that is selected.

## CONFIGURATION MODE EXIT

The configuration mode is exited by writing 0x80 to Address 1010b. A communication handshake is transmitted by the ADXL180 after the configuration mode exit address is written. The ADXL180 reenters its start-up sequence at the beginning of the initialization phase (Phase 1) immediately upon exiting the configuration mode. This method does not generate a device reset. Alternatively, the configuration mode can be exited by lowering the bus supply voltage to cause a power-on-reset to occur. This method generates a device reset.

## SERIAL NUMBER AND MANUFACTURER IDENTIFICATION DATA REGISTERS

The serial number and manufacturer identification data registers can be read in configuration mode. The manufacturer identification register is fixed at the mask level. The serial number is programmed during the final manufacturing stages.

The ADXL180 can be configured to send this data as part of the device data transmitted during Phase 2 of the power-up initialization sequence.

## PROGRAMMING THE CONFIGURATION AND USER DATA REGISTERS

When the desired configuration and user data has been written to the UREG and CREG registers, writing a 1 to the configuration/user data program command bit (CUPRG) causes the four bytes of configuration/user data to be permanently written to the configuration/user data OTP fuse memory. The OTP fuses are programmed sequentially by the ADXL180 without further user intervention. This takes about 12 ms ( $t_{CUP}$  in Figure 41). The ADXL180 ignores all test system read and write commands while it is programming the fuses.

The ADXL180 acknowledges the completion of the programming sequence of the configuration/user data OTP memory by sending the contents of the CREG2 register as described in the Configuration Mode Transmit Communications Protocol section. The CREG2 register contains the configuration/user data programming bit (CUPRG). This allows the test/configuration system to verify that the configuration/user data programming bit has been programmed without further communication. The contents of all of the configuration and user registers should then be read to confirm that they have been programmed to the desired settings. Figure 41 illustrates a sample sequence of commands to write and then program the configuration and user registers.

Once programmed, the OTP fuse memory settings are loaded into the RAM registers during the Phase 1 initialization of the ADXL180 start-up sequence. Figure 42 shows the basic structure of the configuration and user RAM/OTP memory structure.

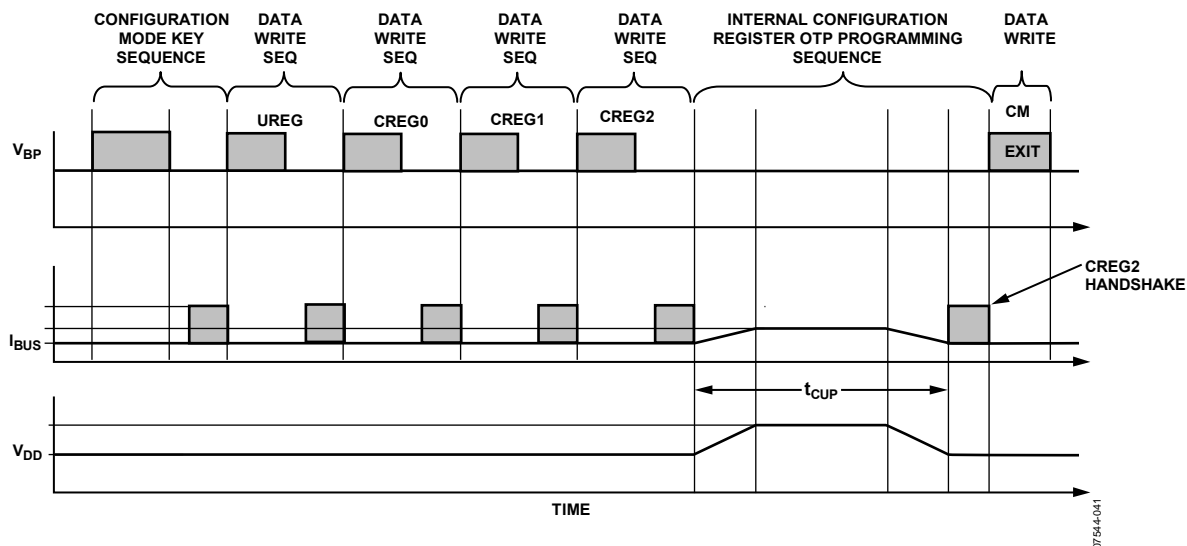

Figure 41. Example Configuration Register OTP Programming Sequence

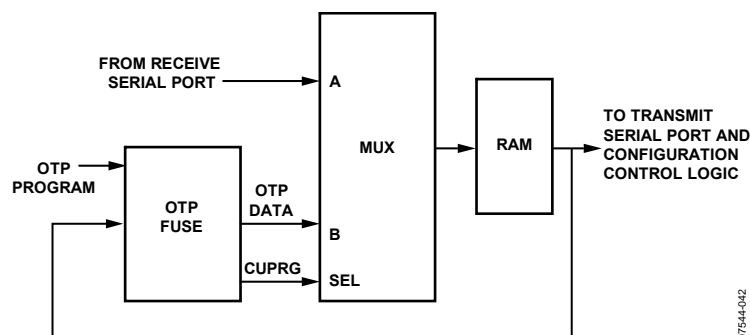

Figure 42. Configuration Mode RAM and OTP Register Structure

The CUPRG bit is automatically programmed to the locked state (1) at the end of the configuration/user data OTP fuse programming sequence. This prevents any further writes to the UREG and CREG RAM registers as well as disables the configuration/user data OTP fuse programming circuitry. The read value of this bit indicates whether the configuration/user data OTP memory has been programmed (that is, locked). A 1 indicates that the OTP memory block has been programmed and further test system writes to either the RAM or OTP configuration/user data registers are ignored.

### OTP PROGRAMMING CONDITIONS AND CONSIDERATIONS

Note that all configuration/user OTP registers are programmed when the CUPRG bit is set regardless of whether the registers have been written to. The OTP registers can be programmed one time only.

During normal operation and in configuration mode, the internal voltage regulator is operating at 4.2 V nominal. This internal voltage changes to a nominal value of 6.5 V during the time that the ADXL180 is programming the configuration and user OTP fuses ( $t_{CUP}$ ). The  $V_{BP}$  supply voltage must be held at or above the minimum fuse programming value specified in the specification table for proper fuse programming. The  $V_{BP}$  supply current is increased during fuse programming as shown in Figure 41. The configuration/test system must supply at least the value  $I_{FP}$  as specified. The configuration and user registers are production tested for user programming at 25°C.

If the minimum programming voltage is not achieved, the ADXL180 does not respond to subsequent communications requests because it waits for the required programming voltage. The device does not attempt to program unless the required voltage level is achieved. The user's test system should include a timeout check if the device does not respond due to this situation. When properly programmed, the ADXL180 issues a

handshake back to the command module. Do not attempt to write to the configuration registers or attempt another OTP programming step until this handshake has been received.

### CONFIGURATION/USER REGISTER OTP PARITY

The configuration/user data OTP CU parity bit (CUPAR) must be programmed to provide even parity for the configuration/user data OTP memory. The CUPAR bit should be set to either a 1 or a 0 to make the total number of 1s in the configuration/user data OTP memory (including the value of the OTP CU parity bit) an even number. The configuration/user data OTP memory is defined as CREG0, CREG1, CREG2, and UREG. The parity calculation must include the state of all register bits including all of the UD and NU bits. The CUPRG bit must also be included. During normal operation, once the configuration/user data programming bit is set, the ADXL180 monitors the parity of the configuration/user data OTP memory and compares it against the programmed value of the CU parity bit in CREG2. An OTP parity error is flagged if the monitored parity and the programmed parity differ. See the Error Detection section.

### CONFIGURATION MODE ERROR REPORTING

The receive communication parity error and the OTP programming voltage error are the two errors reported by the ADXL180 when in configuration mode. The OTP parity, configuration and other normal mode (run-time) errors are suppressed in configuration mode. The state vector code is set to a state vector of 5 (101b). The 8-bit error data code is shown in Table 43. The 4-bit address field is set to 8 (1000b).

Table 43. Configuration Mode Error Codes

Error Data Code	Error Description
0000 0000b	Configuration mode receive parity error

# ADXL180

## CONFIGURATION REGISTER REFERENCE

The following tables define the codes for each programmable field in the three configuration registers (CREG0, CREG1, and CREG2). The default setting (unprogrammed state) of all bits in all configuration registers is zero. As a result, the default configuration of the ADXL180 is compatible with the ADIFX operation mode and communication protocol as implemented in the ADXS101 satellite transmitter.

**Table 44. Configuration and User Data Bit Map<sup>1, 2</sup>**

Configuration Mode Register Address	Configuration Mode Register Name	MSB	D6	D5	D4	D3	D2	D1	LSB
		D7							D0
0000b	UREG	UD7	UD6	UD5	UD4	UD3	UD2	UD1	UD0
0001b	CREG0	UD8	BDE	MD1	MD0	FDLY	DLY2	DLY1	DLY0
0010b	CREG1	STI	AZE	SYEN	ADME	ERC	SVD	DAT	MAN
0011b	CREG2	CUPRG	CUPAR	SCOE	FC1	FC0	RG2	RG1	RG0
0100b...1001b	NU	X	X	X	X	X	X	X	X
1010b	CMEXIT	1	0	0	0	0	0	0	0
1011b	SN0	SNB7	SNB6	SNB5	SNB4	SNB3	SNB2	SNB1	SNB0
1100b	SN1	SNB15	SNB14	SNB13	SNB12	SNB11	SNB10	SNB9	SNB8
1101b	SN2	SNB23	SNB22	SNB21	SNB20	SNB19	SNB18	SNB17	SNB16
1110b	SN3	SNB31	SNB30	SNB29	SNB28	SNB27	SNB26	SNB25	SNB24
1111b	MFGID	SNPRG	SNPAR	REV2	REV1	REV0	MFGID2	MFGID1	MFGID0

<sup>1</sup> X is don't care.

<sup>2</sup> NU is not used.

## UD[7:0] USER DATA BITS

The user register is for arbitrary user data. It does not have any influence on sensor operation. This data is transmitted during Phase 2 of the state machine. For more information on transmission format and timing, in particular depending on the setting of MD bits, see the ADXL180 State Machine section.

**Table 45. User Data Bit Definitions**

Bit Names	Definition
UD0	User Data Bit 0. No function, data only.
UD1	User Data Bit 1. No function, data only.
UD2	User Data Bit 2. No function, data only.
UD3	User Data Bit 3. No function, data only.
UD4	User Data Bit 4. No function, data only.
UD5	User Data Bit 5. No function, data only.
UD6	User Data Bit 6. No function, data only.
UD7	User Data Bit 7. No function, data only.

## UD8 CONFIGURATION BIT

**Table 46. UD8 Configuration Bit**

UD8	Definition
0	Reserved, don't care (default)
1	Reserved, don't care

The value of the RS bit may be transmitted during Phase 2, independent of UD[7:0], depending on the selection of the MD bits.

## BDE

**Table 47. Bus Discharge Enable**

BDE	Definition
0	Bus discharge disabled (default).
1	Bus discharge enabled. Only active when SYEN = 1.

The bus discharge enable (BDE) bit enables a discharge of the bus voltage after a synchronization pulse is detected. If the BDE bit is set, the ADXL180 changes the bus current ( $I_{BUS}$ ) level from  $I_{IDLE}$  to  $I_{SIG}$  when a valid synchronization pulse has been detected. See the Synchronous Communication section for more details and timing information.

## SCOE

**Table 48. SCOE  $V_{SCO}$  Signal Chain Output Enable**

SCOE	Definition
0	$V_{SCO}$ output disabled. (Default.)
1	$V_{SCO}$ output enabled. Analog output prior to ADC conversion is present on $V_{SCO}$ pin. Connect $V_{SCO}$ to high impedance input or data or sensor data may be adversely affected.

## FDLY

**Table 49. Fixed Delay Mode**

FDLY	Definition
0	Fixed delay mode disabled (default).
1	Fixed delay mode enabled. Device transmits data in the time slot delayed by $t_{DLY}$ as defined by DLY[2:0].

## ADME

**Table 50. Autodelay Mode Enable (ADME) Options**

ADME	Definition
0	Autodelay mode disabled. The part does not check for a second device on the line and does not pull any extra current during startup. (Default.)
1	Autodelay mode detection enabled. $I_{DET}$ pull-down for 6 ms at power-up.

## STI

**Table 51. Self Test Internal (STI) Options**

STI	Definition
0	External self-test. User must monitor self-test data to verify proper operation. Device does not monitor its own response to the self-test stimulus. (Default.)
1	Internal self-test. The device monitors its own self-test data to determine proper operation.

**Table 52. Phase 3 Data Transmitted When STI = 1**

MD1	MD0	Data
0	0	Device OK
0	1	Range
1	0	Delimiter
1	1	Device OK

## FC[1:0]

**Table 53. FC Low-Pass Filter Bandwidth Frequency Select Codes**

FC1	FC0	-3 dB LP Frequency
0	0	400 Hz
0	1	200 Hz
1	0	100 Hz
1	1	800 Hz

## RG[2:0]

**Table 54. RG[2:0] Sensor Range Select Codes**

RG2	RG1	RG0	Range
0	0	0	$\pm 50 g$
0	0	1	$\pm 100 g$
0	1	0	$\pm 250 g$
0	1	1	$\pm 150 g$
1	0	0	$\pm 200 g$
1	0	1	$\pm 350 g$
1	1	0	$\pm 500 g$
1	1	1	Not used

# ADXL180

## MD[1:0]

**Table 55. Phase 2 (Device Data) Transmission Mode Select Codes**

MD1	MD0	Name	Definition
0	0	Mode 0	ADIFX mode device data
0	1	Mode 1	Range data only (range selection limited)
1	0	Mode 2	8-bit coded device data
1	1	Mode 3	10-bit coded device data

**Table 56. Phase 2 (Device Data) Transmission Mode Select Codes**

MD1	MD0	Data
0	0	Device OK
0	1	Range
1	0	Delimiter
1	1	Device OK

**Table 57. MD Settings and Device Data Ranges with SVD and AZE Settings (Replication of Table 23)**

Mode (Device Data)	MD1	MD0	SVD <sup>1</sup>	AZE <sup>2</sup>	Data Range
0: ADIFX <sup>3</sup> (All Configuration Data, Serial Number And Manufacturer ID)	0	0	0	0	Full
	0	0	0	1	Reduced
	0	0	1	0	Configuration error
	0	0	1	1	Configuration error
1: Range Data Only <sup>3</sup> (Limited Range Selection)	0	1	0	0	Full
	0	1	0	1	Reduced
	0	1	1	0	Reduced
	0	1	1	1	Reduced
2: 8-Bit Coded Device Data <sup>3</sup> (UD[7:0], Serial Number And Range)	1	0	0	0	Full
	1	0	0	1	Reduced
	1	0	1	0	Reduced
	1	0	1	1	Reduced
3: 10-Bit Coded Device Data <sup>4</sup> (UD[7:0], Serial Number And Range)	1	1	0	0	Full
	1	1	0	1	Reduced
	1	1	1	0	Reduced
	1	1	1	1	Reduced

<sup>1</sup> SVD is the state vector disable configuration bit.

<sup>2</sup> AZE is the auto-zero enable configuration bit.

<sup>3</sup> If Phase 2 Mode 0, Mode 1, or Mode 2 is selected, the device data is 8-bit data. If the 10-bit data mode is selected in combination with Phase 2 Mode 0, Mode 1, or Mode 2, the 8-bit device data is left justified in the 10-bit data field. The two LSBs are held at zero (see Table 24).

<sup>4</sup> The 10-bit device data mode (Phase 2 Mode 3) is incompatible with the 8-bit data mode (the DAT bit is set to 1). The device transmits a configuration error code if Phase 2 Mode 3 is selected and the DAT bit is set to 1. No sensor data is transmitted.

**SYEN****Table 58. Sync Enable (SYEN) Options**

SYEN	Definition
0	Synchronization pulse disabled. Device transmits data according to state machine based on internal clock every 228 $\mu$ s when powered (default).
1	Synchronization pulse enabled. The device requires a synchronization pulse to sample and transmit data according to state machine.

**AZE****Table 59. AZE Auto Zero Enable**

AZE	Definition
0	Auto-zero function is disabled. Phase 4 has no messages. Device immediately moves to normal data (Phase 5) after self-test (Phase 3). (Default.)
1	Auto-zero function enabled. See Auto-Zero Operation section for details.

**ERC****Table 60. Error Check (ERC) Bit Options**

ERC	Definition
0	3-bit CRC is included in message. Calculate CRC using the polynomial $x^3 + x^1 + x^0$ . (Default.)
1	One parity bit is included in the message. CRC is not used. It is a bit that is set such that even parity is achieved in the transmitted message.

**DAT****Table 61. DAT Data Bit Options**

DAT	Definition
0	10-bit data sensor data transmitted. 8-bit Phase 2 configuration data left-justified in 10-bit data frame (default).
1	8-bit sensor data transmitted.

**SVD****Table 62. SVD Data Bit Options**

SVD	Definition
0	State vector enabled (default).
1	State vector disabled, reduced data range used.

**CUPAR AND CUPRG****Table 63. Device Configuration Bit Definitions**

Name	Setting	Definition
CUPAR	0	Data dependent setting
	1	Data dependent setting
CUPRG	0	Configuration OTP memory not programmed
	1	Configuration OTP memory programmed

## AXIS OF SENSITIVITY

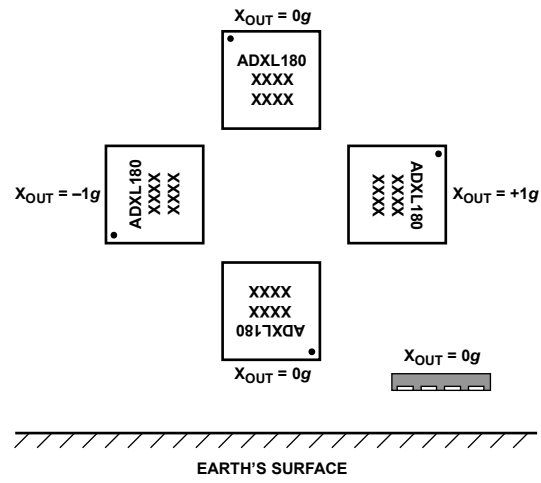

Figure 43. Output Response vs. Orientation



## BRANDING

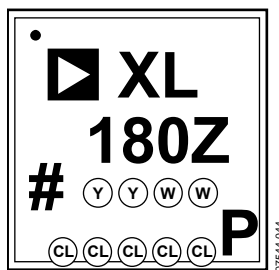

Figure 44. ADXL180 Laser Brand

Table 64. ADXL180 Branding Key

Line	Text	Description
1	XL	Accelerometer
2	180Z	ADXL180Z
3	YY	Year code
3	WW	Week code
4	CL	Lot code
4	P	Country of origin (Philippines)

# ADXL180

## OUTLINE DIMENSIONS

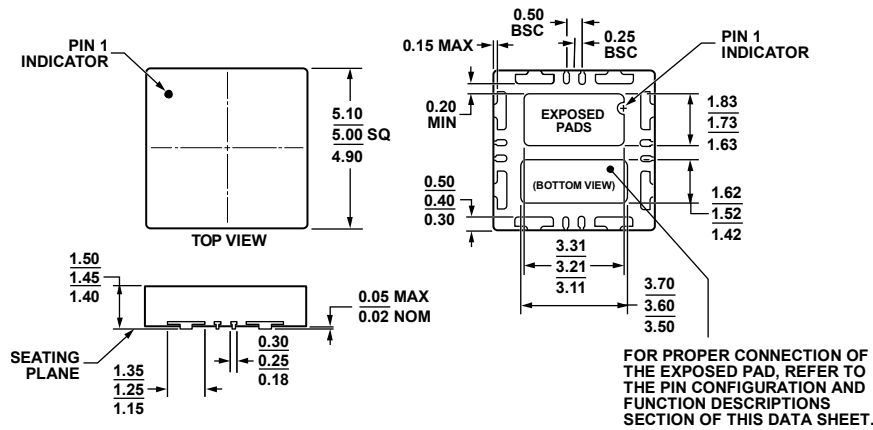

Figure 45. 16-Lead Lead Frame Chip Scale Package [LFCSP\_LQ]  
 5 mm × 5 mm Body, Thick Quad  
 (CP-16-8)  
 Dimensions shown in millimeters

## ORDERING GUIDE

Model	Temperature Range	Package Description	Package Option
ADXL180WCPZ-RL <sup>1</sup>	-40°C to +125°C	16-Lead LFCSP_LQ	CP-16-8

<sup>1</sup> Z = RoHS Compliant Part.

**NOTES**

**ADXL180**

**NOTES**