

Features

- Operating voltage: 2.0V~5.5V
- Maximum input serial clock: 500kHz at $V_{DD}=2V$, 2MHz at $V_{DD}=5V$
- Operating current: less than 400nA at 2V, less than 1.2 μ A at 5V
- TTL compatible
 - V_{IH} : 2.0V~ $V_{DD}+0.3V$ at $V_{DD}=5V$
 - V_{IL} : -0.3V~+0.8V at $V_{DD}=5V$
- Two data transmission modes: single-byte, or burst mode
- Serial I/O transmission
- All registers store BCD format
- HT1380: 8-pin DIP package
- HT1381: 8-pin SOP package

Applications

- Microcomputer serial clock
- Clock and Calendar

General Description

The HT1380/HT1381 is a serial timekeeper IC which provides seconds, minutes, hours, day, date, month and year information. The number of days in each month and leap years are automatically adjusted. The HT1380/HT1381 is designed for low power consumption and can operate in two modes: one is the 12-hour mode with an AM/PM indicator, the other is the 24-hour mode.

The HT1380/HT1381 has several registers to store the corresponding information with 8-bit data format. A 32768Hz crystal is required to provide the correct timing. In order to minimize the pin number, the HT1380/HT1381 use a serial I/O transmission method to interface with a microprocessor. Only three wires are required: (1) \overline{REST} , (2) SCLK and (3) I/O. Data can be delivered 1 byte at a time or in a burst of up to 8 bytes.

Block Diagram

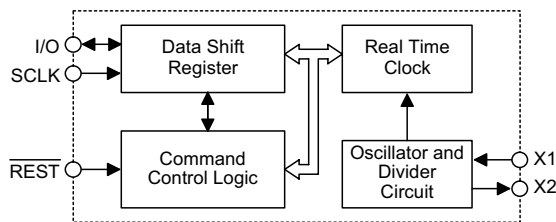

Pin Assignment

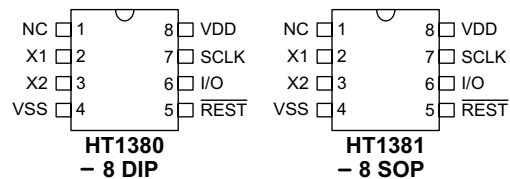

Pad Assignment
Pad Coordinates

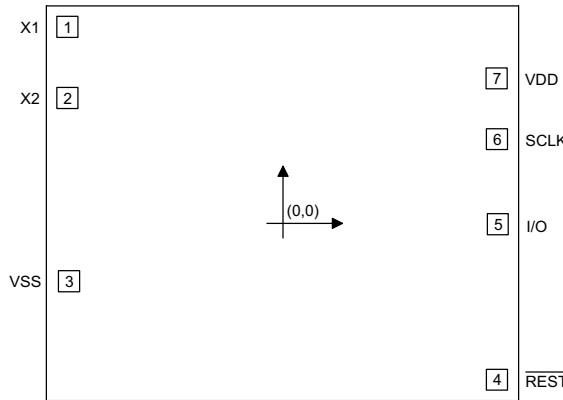
 Unit: μm

Pad No.	X	Y
1	-851.40	775.00
2	-851.40	494.60
3	-844.40	-203.90
4	845.90	-618.30
5	848.40	-4.30
6	845.90	332.60
7	844.40	572.60

 Chip size: $2010 \times 1920 (\mu\text{m})^2$

* The IC substrate should be connected to VSS in the PCB layout artwork.

Pad Description

Pad No.	Pad Name	I/O	Internal Connection	Description
1	X1	I	CMOS	32768Hz crystal input pad
2	X2	O	CMOS	Oscillator output pad
3	VSS	—	CMOS	Negative power supply, ground
4	$\overline{\text{REST}}$	I	CMOS	Reset pin with serial transmission
5	I/O	I/O	CMOS	Data input/output pin with serial transmission
6	SCLK	I	CMOS	Serial clock pulse pin with serial transmission
7	VDD	—	CMOS	Positive power supply

Absolute Maximum Ratings

Supply Voltage -0.3V to 5.5V Storage Temperature -50°C to 125°C
 Input Voltage $V_{SS}-0.3\text{V}$ to $V_{DD}+0.3\text{V}$ Operating Temperature 0°C to 70°C

Note: These are stress ratings only. Stresses exceeding the range specified under "Absolute Maximum Ratings" may cause substantial damage to the device. Functional operation of this device at other conditions beyond those listed in the specification is not implied and prolonged exposure to extreme conditions may affect device reliability.

D.C. Characteristics

Ta=25°C

Symbol	Parameter	Test Conditions		Min.	Typ.	Max.	Unit
		V _{DD}	Conditions				
V _{DD}	Operating Voltage	—	—	2	—	5.5	V
I _{STB}	Standby Current	2V	—	—	—	100	nA
		5V		—	—	100	nA
I _{DD}	Operating Current	2V	No load	—	0.7	1.0	μA
		5V		—	0.7	1.2	μA
I _{OH}	Source Current	2V	V _{OH} =1.8V	-0.2	-0.4	—	mA
		5V	V _{OH} =4.5V	-0.5	-1.0	—	mA
I _{OL}	Sink Current	2V	V _{OL} =0.2V	0.7	1.5	—	mA
		5V	V _{OL} =0.5V	2.0	4.0	—	mA
V _{IH}	"H" Input Voltage	5V	—	2	—	—	V
V _{IL}	"L" Input Voltage	5V	—	—	—	0.8	V
f _{OSC}	System Frequency	5V	32768Hz X'TAL	—	32768	—	Hz
f _{SCLK}	Serial Clock	2V	—	—	—	0.5	MHz
		5V		—	—	—	2

* I_{STB} is specified with SCLK, I/O, $\overline{\text{RST}}$ open. The clock halt bit must be set to logic 1 (oscillator disabled).

A.C. Characteristics

Ta=25°C

Symbol	Parameter	Test Conditions		Min.	Max.	Unit
		V _{DD}	Conditions			
t _{DC}	Data to Clock Setup	2V	—	200	—	ns
		5V	—	50	—	
t _{CDH}	Clock to Data Hold	2V	—	280	—	ns
		5V	—	70	—	
t _{CDD}	Clock to Data Delay	2V	—	—	800	ns
		5V	—	—	200	
t _{CL}	Clock Low Time	2V	—	1000	—	ns
		5V	—	250	—	
t _{CH}	Clock High Time	2V	—	1000	—	ns
		5V	—	250	—	
f _{CLK}	Clock Frequency	2V	—	—	0.5	MHz
		5V	—	D.C.	2.0	

Symbol	Parameter	Test Conditions		Min.	Max.	Unit
		V _{DD}	Conditions			
t _r	Clock Rise and Fall Time	2V	—	—	2000	ns
t _f		5V	—	—	500	
t _{CC}	Reset to Clock Setup	2V	—	4	—	us
		5V	—	1	—	
t _{CCH}	Clock to Reset Hold	2V	—	240	—	ns
		5V	—	60	—	
t _{CWH}	Reset Inactive Time	2V	—	4	—	us
		5V	—	1	—	
t _{CDZ}	Reset to I/O High Impedance	2V	—	—	280	ns
		5V	—	—	70	

Functional Description

The HT1380/HT1381 mainly contains the following internal elements: a data shift register array to store the clock/calendar data, command control logic, oscillator circuit and read timer clock. The clock is contained in eight read/write registers as shown below. Data contained in the clock register is in binary coded decimal format.

Two modes are available for transferring the data between the microprocessor and the

HT1380/HT1381. One is in single-byte mode and the other is in multiple-byte mode.

The HT1380/HT1381 also contains two additional bits, the clock halt bit (CH) and the write protect bit (WP). These bits control the operation of the oscillator and so data can be written to the register array. These two bits should first be specified in order to read from and write to the register array properly.

Command byte

For each data transfer, a Command Byte is initiated to specify which register is accessed. This is to determine whether a read, write, or test cycle is operated and whether a single byte or burst mode transfer is to occur. Refer to the table shown below and follow the steps to write the data to the chip. First give a Command Byte of HT1380/HT1381, and then write a data in the register.

This table illustrates the correlation between Command Byte and their bits:

Function Description	Command Byte							
	C7	C6	C5	C4	C3	C2	C1	C0
Select Read or Write Cycle								R/W
Specify the Register to be Accessed					A2	A1	A0	
Clock Halt Flag	C							
For IC Test Only	1	0	0	1	x	x	x	1
Select Single Byte or Burst Mode	1	0	1	1	1	1	1	x

Note: "x" stands for don't care

The following table shows the register address and its data format:

Register Name	Range Data	Register Definition								Address A2~A0	Bit R/W	Command Byte
		D7	D6	D5	D4	D3	D2	D1	D0			
Seconds	00~59	CH	10 SEC			SEC			000	W R	10000000 10000001	
Minutes	00~59	0	10 MIN			MIN			001	W R	10000010 10000011	
Hours	01~12 00~23	12\ 24	0 0	AP 10	HR HR	HOUR			010	W R	10000100 10000101	
Date	01~31	0	0	10 DATE		DATE			011	W R	10000110 10000111	
Month	01~12	0	0	0	10M	MONTH			100	W R	10001000 10001001	
Day	01~07	0	0	0	0	DAY			101	W R	10001010 10001011	
Year	00~99	10 YEAR			YEAR			110	W R	10001100 10001101		
Write Protect	00~80	WP	ALWAYS ZERO						111	W R	10001110 10001111	

CH: Clock Halt bit

CH=0 oscillator enabled
CH=1 oscillator disabled

WP: Write protect bit

WP=0 register data can be written in
WP=1 register data can not be written in

Bit 7 of Reg2: 12/24 mode flag

bit 7=1, 12-hour mode
bit 7=0, 24-hour mode

Bit 5 of Reg2: AM/PM mode defined

AP=1 PM mode
AP=0 AM mode

R/W signal

The LSB of the Command Byte determines whether the data in the register be read or be written to.

When it is set as "0" means that a write cycle is to take place otherwise this chip will be set into the read mode.

A0~A2

A0 to A2 of the Command Byte is used to specify which registers are to be accessed. There are eight registers used to control the month data, etc., and each of these registers have to be set as a write cycle in the initial time.

Burst mode

When the Command Byte is 10111110 (or 10111111), the HT1380/HT1381 is configured in burst mode. In this mode the eight clock/calendar registers can be written (or read) in series, starting with bit 0 of register address 0 (see the timing on the next page).

Test mode

When the Command Byte is set as 1001xxx1, HT1380/HT1381 is configured in test mode. The test mode is used by Holtek only for testing purposes. If used generally, unpredictable conditions may occur.

Write protect register

This register is used to prevent a write operation to any other register. Data can be written into the designated register only if the Write Protect signal (WP) is set to logic 0. The Write Protect Register should be set first before restarting the system or before writing the new data to the system, and it should set as logic 1 in the read cycle. The Write Protect bit cannot be written to in the burst mode.

Clock Halt bit

D7 of the Seconds Register is defined as the Clock Halt Flag (CH).

When this bit is set to logic 1, the clock oscillator is stopped and the chip goes into a low-power standby mode. When this bit is written to logic 0, the clock will start.

12-hour/24-hour mode

The D7 of the hour register is defined as the 12-hour or 24-hour mode select bit.

When this bit is in high level, the 12-hour mode is selected otherwise it's the 24-hour mode.

AM-PM mode

These are two functions for the D5 of the hour register determined by the value D7 of the same register.

One is used in AM/PM selection on the 12-hour mode. When D5 is logic 1, it is PM, otherwise it's AM. The other is used to set the second 10-hour bit (20~23 hours) on the 24-hour mode.

Reset and Serial Clock control

The $\overline{\text{REST}}$ pin is used to allow access data to the shift register like a toggle switch. When the $\overline{\text{REST}}$ pin is taken high, the built-in control logic is turned on and the address/command sequence can access the corresponding shift register. The REST pin is also used to terminate either single-byte or burst mode data format.

The input signal of SCLK is a sequence of a falling edge followed by a rising edge and it is used to synchronize the register data whether read or write. For data input, the data must be read after the rising edge of SCLK. The data on the I/O pin becomes output mode after the falling edge of the SCLK. All data transfer terminates if the $\overline{\text{REST}}$ pin is low and the I/O pin goes to a high impedance state. The data transfer is illustrated on the next page.

Data in and Data out

In writing a data byte with HT1380/HT1381, the read/write should first set as R/W=0 in the Command Byte and follow with the corresponding data register on the rising edge of the next eight SCLK cycles. Additional SCLK cycles are ignored. Data inputs are entered starting with bit 0.

In reading a data on the register of HT1380/HT1381, R/W=1 should first be entered as input. The data bit outputs on the falling edge of the next eight SCLK cycles. Note that the first data bit to be transmitted on the first falling edge after the last bit of the read command byte is written. Additional SCLK cycles re-transmits the data bytes as long as $\overline{\text{REST}}$ remains at high level. Data outputs are read starting with bit 0.

Crystal selection

A 32768Hz crystal can be directly connected to the HT1380/HT1381 via pin 2 and pin 3 (X1, X2). In order to obtain the correct frequency, two additional load capacities (C1, C2) are needed. The value of the capacity depends on how accurate the crystal is. We suggest that you can follow the table on the next page.

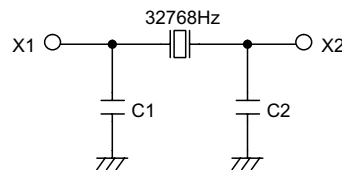

The following diagram shows the single and burst mode transfer:

Single byte transfer

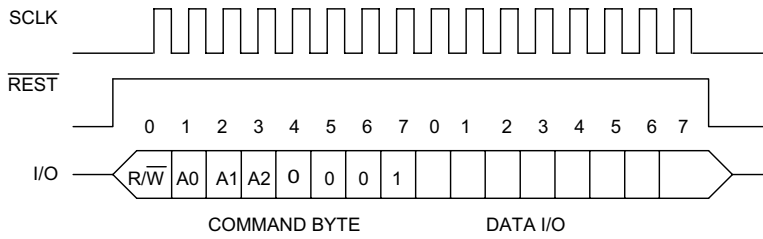

Burst mode transfer

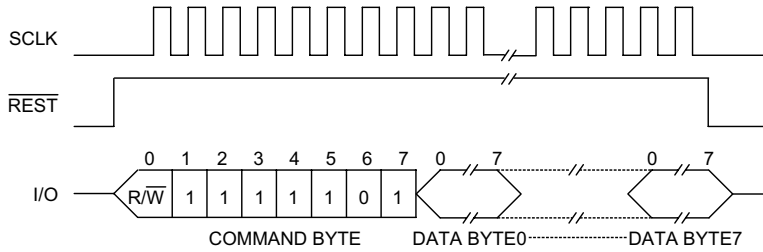

The table illustrates the values suggested for capacities C1, C2

Part No.	Crystal Error	Capacity Value
HT1380/HT1381	±10ppm	5pF
	10~20ppm	8pF

Operating flowchart

To initiate any transfer of data, \overline{REST} is taken high and an 8-bit command byte is first loaded into the control logic to provide the register address and command information. Following the command word, the clock/calendar data is serially transferred to or from the corresponding register. The \overline{REST} pin must be taken low again after the transfer operation is completed. All data enter on the rising edge of SCLK and outputs on the falling edge of SCLK. In total, 16 clock pulses are needed for a single byte mode and 72 for burst mode. Both input and output data starts with bit 0.

In using the HT1380/HT1381, set first the WP and CH to 0 and wait for about 3 seconds, the oscillator will generate the clocks for internal use. Then, choose either single mode or burst mode to input the data. The read or write operating flowcharts are shown on the next page.

- To disable the write protect (WP=0) bit and enable the oscillator (CH=0)

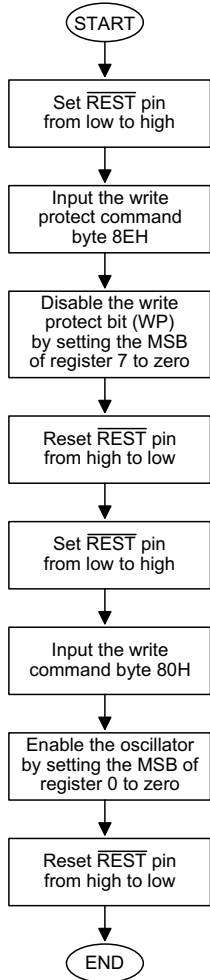

- Single byte data transfer

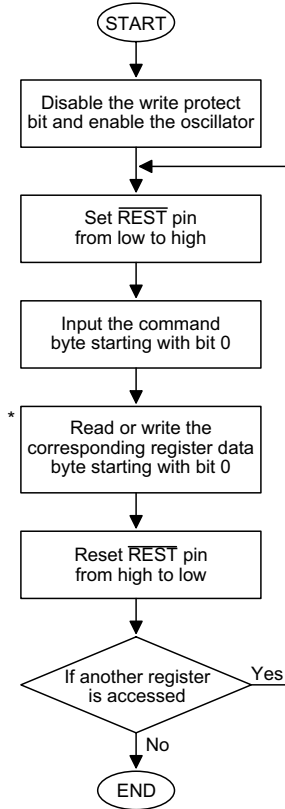

- Burst mode data transfer

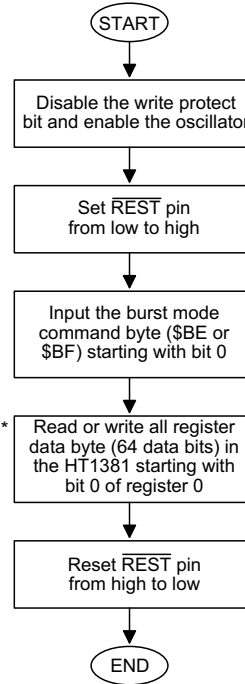

* In reading data byte from HT1380/HT1381 register, the first data bit to be transmitted at the first falling edge after the last bit of the command byte is written.

Timing Diagrams

Read data transfer

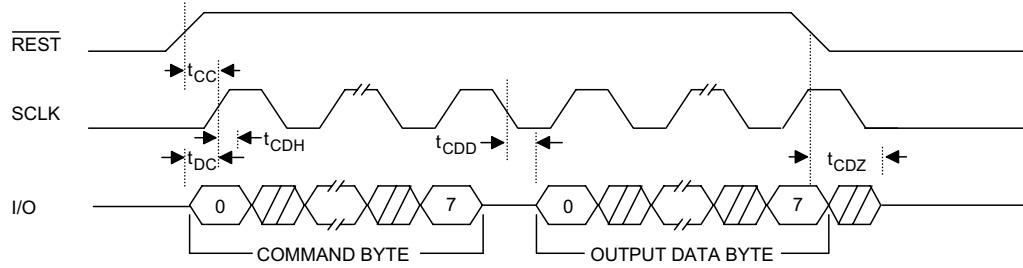

Write data transfer

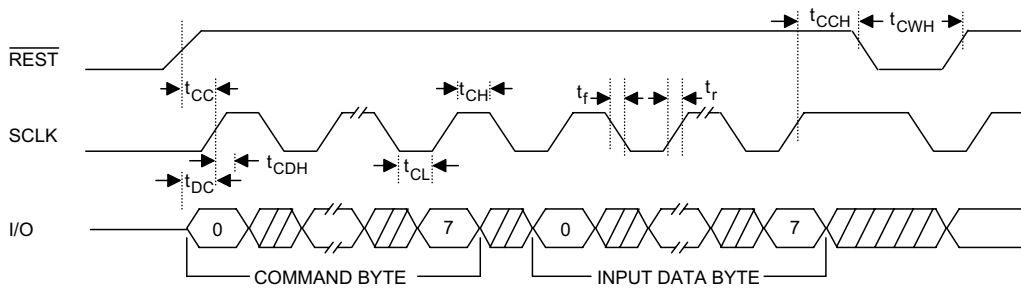

Application Circuits

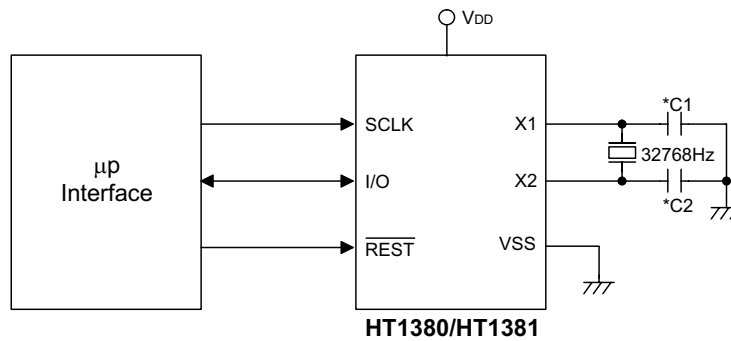

*Note: The value of the capacity depends on how accurate the crystal is.
Refer to the suggestion table of page 7.

Holtek Semiconductor Inc. (Headquarters)

No.3, Creation Rd. II, Science Park, Hsinchu, Taiwan
Tel: 886-3-563-1999
Fax: 886-3-563-1189
<http://www.holtek.com.tw>

Holtek Semiconductor Inc. (Taipei Sales Office)

4F-2, No. 3-2, YuanQu St., Nankang Software Park, Taipei 115, Taiwan
Tel: 886-2-2655-7070
Fax: 886-2-2655-7373
Fax: 886-2-2655-7383 (International sales hotline)

Holtek Semiconductor Inc. (Shanghai Sales Office)

7th Floor, Building 2, No.889, Yi Shan Rd., Shanghai, China 200233
Tel: 021-6485-5560
Fax: 021-6485-0313
<http://www.holtek.com.cn>

Holtek Semiconductor Inc. (Shenzhen Sales Office)

5/F, Unit A, Productivity Building, Cross of Science M 3rd Road and Gaoxin M 2nd Road, Science Park,
Nanshan District, Shenzhen, China 518057
Tel: 0755-8616-9908, 8616-9308
Fax: 0755-8616-9533

Holtek Semiconductor Inc. (Beijing Sales Office)

Suite 1721, Jinyu Tower, A129 West Xuan Wu Men Street, Xicheng District, Beijing, China 100031
Tel: 010-66410030, 66417751, 66417752
Fax: 010-66410125

Holtek Semiconductor Inc. (Chengdu Sales Office)

709, Building 3, Champagne Plaza, No.97 Dongda Street, Chengdu, Sichuan, China 610016
Tel: 028-6653-6590
Fax: 028-6653-6591

Holmate Semiconductor, Inc. (North America Sales Office)

46729 Fremont Blvd., Fremont, CA 94538
Tel: 510-252-9880
Fax: 510-252-9885
<http://www.holmate.com>

Copyright © 2000 by HOLTEK SEMICONDUCTOR INC.

The information appearing in this Data Sheet is believed to be accurate at the time of publication. However, Holtek assumes no responsibility arising from the use of the specifications described. The applications mentioned herein are used solely for the purpose of illustration and Holtek makes no warranty or representation that such applications will be suitable without further modification, nor recommends the use of its products for application that may present a risk to human life due to malfunction or otherwise. Holtek's products are not authorized for use as critical components in life support devices or systems. Holtek reserves the right to alter its products without prior notification. For the most up-to-date information, please visit our web site at <http://www.holtek.com.tw>.