



**Intronics
Power®**

Ultra Low Bias Current Varactor Bridge Operational Amplifiers

MODELS 310, 311

FEATURES

- Guaranteed Low Bias: 10^{-14} A max
- Low Voltage Drift: $10\mu\text{V}/^\circ\text{C}$ max (310K, 311K)
- Versatility: Noninverting, model 311J/K
Inverting, model 310J/K
- High Input Impedance: $10^{14}\Omega$ (311J, 311K)

APPLICATIONS

- Femto-ammeter
- Electrometer
- Long-Time Integrator
- Small-Rate Differentiator
- Flame Current Detector
- Phototube Amplifier
- Log Compressor
- pH Meter

GENERAL DESCRIPTION

The Analog Devices' models 310 and 311 are operational amplifiers with extremely low input bias currents and high input impedances. As such, they are applicable to a large number of *electrometer* amplifier applications which have traditionally been fulfilled (not without difficulty) by vacuum electrometer tubes. These specialized requirements are characterized by extremely high source impedances or where infinitesimal currents must be measured or amplified. Because of varactor bridge inputs, the all solid state 310 and 311 amplifiers are ideally suited to this type of requirement. Voltage drifts are small, noise is minimized, and the cost is low. In principle, the operation of varactor bridge amplifiers is similar to that of vibrating reed electrometers (parametric), but also includes the inherent advantages of solid state design.

VOLTAGE SOURCE OR CURRENT SOURCE?

Model 310 – The model 310 is designed such that the high quality signal input is the *inverting* input terminal, and is most appropriate for measurements of *current* signals. This type of signal source is common to gas chromatograph flame detectors, photomultiplier tubes, radiation detectors, etc. The inverting model 310 is also useful for logarithmic compression over an extremely wide dynamic range and in the construction of very-long-time-constant integrators or differentiators. Input signals from picoamps to milliamps may be accommodated with femtoamp current resolution.

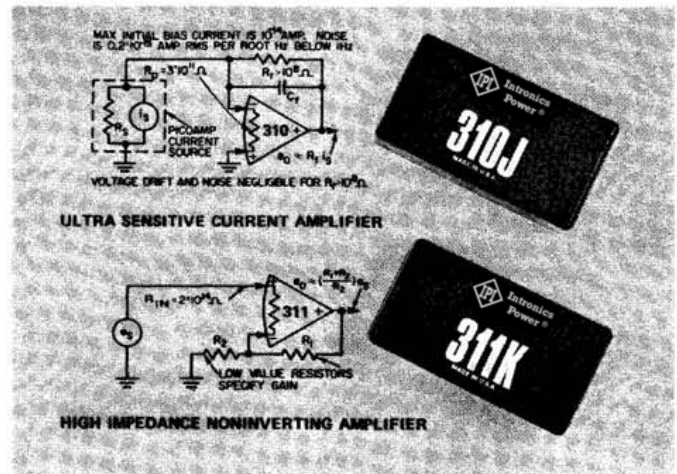

Model 311 – The 311 is similar to the 310 but the high quality input is the positive or *non-inverting* input. It is primarily intended for measurement of voltages from very high source impedances. Such sources are found in the glass electrodes of pH cells and other scientific measurement apparatus. Another such source is charge stored on the plates of a capacitor, as is found in long-time track-and-hold applications.

Table 1. Comparison of Electrometer Types

TYPE	VARACTOR BRIDGE	VIBRATING CAPACITOR	MOSFET	ELECTROMETER TUBES
I-Stability	good	excellent	good	good
V-Stability	excellent	excellent	fair	poor
Bandwidth	narrow	narrow	wide	wide
Overload Protection	easy	easy	difficult	—
CMR	excellent	excellent	fair	poor
Microphonics	fair	fair	good	poor
Warm-Up	fast	fast	fast	slow
Size	small	large	small	large
Price	low	high	medium	medium

The chart above shows the relative advantages of various electrometer types. The best performance possible is given by the vibrating reed electrometer. It should be remembered, however, that this is a large, expensive laboratory instrument not generally suitable for instrument construction.

1400 PROVIDENCE HIGHWAY • BUILDING 2 NORWOOD, MASSACHUSETTS 02062-5015
PHONE: 781-551-5500 FAX: 781-551-5555

SPECIFICATIONS (typical @ +25°C and ±15VDC unless otherwise noted)

MODEL	310J/K	311J/K
OPEN LOOP GAIN		
DC 2kΩ Load	10 ⁵ min	*
RATED OUTPUT		
Voltage, 2kΩ Load	±10V min	*
Current	±5mA min	*
Load Capacitance	up to 1nF	*
FREQUENCY RESPONSE		
Unity Gain, Small Signal	2kHz	*
Full Power Response	7Hz min	*
Slew Rate	0.4V/ms min	*
Overload Recovery	10ms	*
INPUT OFFSET VOLTAGE		
Initial, @ +25°C	±10mV max	*
With External Trim Pot	Adj. to zero	*
vs. Temp (0 to +70°C) max	±30μV/°C (J)	±30μV/°C (J)
	±10μV/°C (K)	±10μV/°C (K)
vs. Supply Voltage	±100μV/%	*
vs. Time	±100μV/mo	*
Warm-Up Drift	75μV (15 min)	*
INPUT BIAS CURRENT		
Initial Bias, +25°C		
Inverting Input	±10fA ² max	±1nA max
Non-Inverting Input	±1nA max	±10fA max
vs. Temp (Signal Input Only) ¹	x 2/+7°C	*
vs. Supply Voltage (Signal Input Only)	±2fA/%	*
INPUT IMPEDANCE		
Differential	3 x 10 ¹¹ Ω 30pF	*
Inverting Input (To Common)	—	10 ⁹ Ω 20nF
Non-Inverting Input (To Common)	—	10 ¹⁴ Ω 2pF
INPUT NOISE		
Voltage, 0.01 to 1Hz	10μV p-p	*
1 to 100Hz	10μV rms	*
Current, 0.01 to 1Hz	1fA p-p	*
1 to 100Hz	2fA rms	*
COMMON MODE CHARACTERISTICS		
Max Safe Differential Voltage	±300V	*
Max Common Mode	NA	±25V
Common Mode Rejection @ ±25V	NA	10 ⁵
POWER SUPPLY		
Voltage, Rated Performance	±15V	*
Voltage, Operating	±(12 to 18)V	*
Current, Quiescent	+15, -6mA max	*
TEMPERATURE RANGE		
Rated Performance	0 to +70°C	*
Operating	-25°C to +85°C	*
Storage	-55°C to +85°C	*
MECHANICAL		
Case Size	3" x 1.6" x 0.69"	*
Mating Socket	AC1017	*
Socket Shield	AC1118	*

OUTLINE DIMENSIONS

Dimensions shown in inches and (mm)

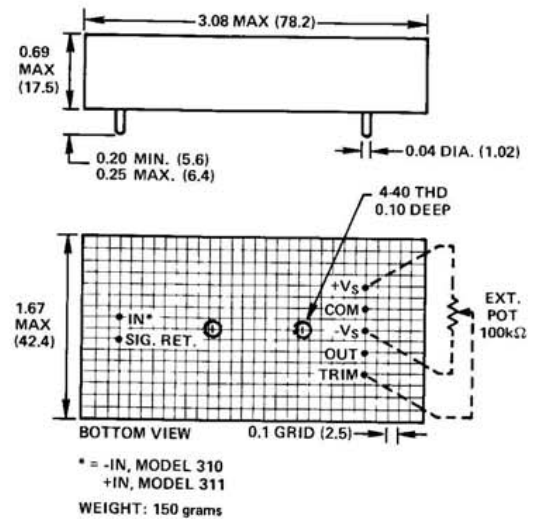

MATING SOCKET

AC1017

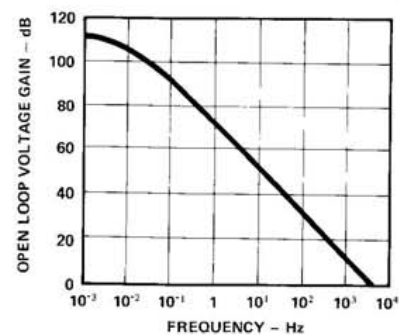
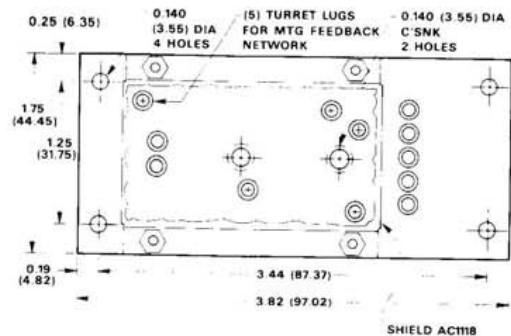

Frequency Response

¹ Negative input for 310, positive input for 311.

² 1fA (femtoamp) = 10⁻¹⁵A.

*Specifications same as 310J/K.

Specifications subject to change without notice.

APPLICATION CONSIDERATIONS

The relatively large capacitance between inputs of varactor bridge amplifiers is a cause for stability problems when large feedback resistors are used. These stability problems can usually be cured at the expense of bandwidth by judiciously adding an external capacitor.

For the current amplifier (Figure 1) this capacitor, C_f , is added in parallel with R_f . A value of 0 to 5pF for C_f is normally required for the 310, but to optimize bandwidth a square wave should be applied at the input and C_f should be adjusted for the desired output transient response. Where bandwidth is not required, C_f should be increased to limit the bandwidth and thus reduce noise.

Note that bandwidth is sacrificed when C_f is made arbitrarily large since bandwidth is proportional to $1/R_f C_f$.

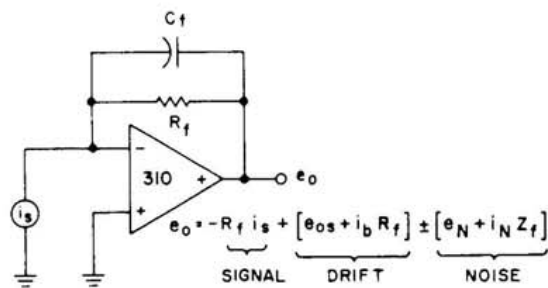

Figure 1. Improving Closed Loop Stability Inverting Configuration

To improve stability for the noninverting amplifier (Figure 2), a capacitor C_i is required from the plus input to ground. Although the value for C_i depends primarily on the source impedance, R_s , in most cases a few picofarads should be adequate. In this configuration the use of C_i degrades bandwidth since R_s and C_i form a low pass filter and reduce the dynamic input impedance.

Remember when choosing a capacitor type that the leakage resistance of the capacitor can be very critical. The capacitor chosen should have at least 10^{14} ohms insulation. The type SX polystyrene capacitor manufactured by Mallory is suitable.

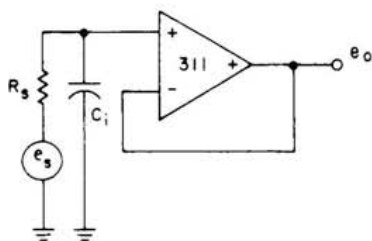

Figure 2. Improving Closed Loop Stability Noninverting Configuration

LEAKAGE RESISTANCE

In working with picoamp signals and/or impedance values in the range from 10^7 to 10^{11} ohms, attention to insulation and guarding techniques is extremely important. For example, a leakage resistance of 10^{14} ohms from the 15 volt power supply to the negative input of the 310 will cause a 150fA error current which is 15 times greater than the 10fA bias current guaranteed for this amplifier. The insulation resistance of most commercial wire, connectors, printed circuit boards, switches and other interconnection devices fall considerably short of 10^{14} ohms, particularly on a humid day. Teflon and ceramic are about the only reliable insulators in applications where one is serious about measuring fractions of picoamps or in obtaining maximum input impedance. Teflon wire and ceramic switches are available with acceptance insulator properties.

Analog Devices offers mating sockets for model 310 and model 311 amplifiers which use teflon-insulated receptacles.

HIGH VALUE RESISTORS

Frequently very large resistance values are required with the 300 series. Metal film resistors are recommended. One source of these resistors is Electra Mfg. Co.* which specializes in metal film resistors which are available up to 10^7 ohms. A source for higher value resistors is Victoreen.** This firm offers special carbon resistors up to 10^{14} ohms. The high value carbon resistors have a relatively large temperature coefficient, about 1000ppm, and the tolerance of resistance values is 1 to 10%. Moreover, these devices also have a substantial voltage coefficient, which means that the resistance will vary with applied voltage, particularly for large voltages; also, the long term stability is poor. As a rule, degradation in performance increases with increasing resistance value.

By contrast, metal film resistors have much better coefficients, about 100ppm, accuracy to 0.1%, and better long term stability.

From this discussion it is apparent that smaller errors due to feedback resistors are obtained with lower resistance values. Figure 3 shows a technique for circumventing the use of very large value resistors for a current amplifier.

This circuit multiplies the effective value of R_1 , by the ratio $(R_2 + R_3)/R_2$. For example, if one requires a sensitivity of 10mV/pA, the value for R_f in Figure 1 (Inverting Configuration) would be 10^{10} ohms. However, in Figure 3, the same sensitivity is obtained when $R_1 = 10^8$ ohms and $(R_2 + R_3)/R_2 = 100$. Reasonably well behaved resistors of 10^8 are available.

*Address: 3151 Fiberglass Rd., Kansas City, Kansas 66115.
**Address: 10101 Woodland Ave., Cleveland, Ohio 44114.

INSTALLATION NOTES

Because of the phenomenal sensitivity of models 310 and 311, they must be installed and used with more care than is required for more conventional operational amplifiers.

Insulation and shielding of all components and wiring associated with the "hot" input terminal (inverting input of model 310, non-inverting input of model 311) must be near perfect. Insulators of clean teflon are preferable, but polyethylene, or glass types are also suitable. Dirt and moisture do not adhere to teflon, but if required it may be cleaned with methy alcohol.

Models 310 and 311 are enclosed in metal-shielded cases. The mating socket provides stand-off insulators for mounting resistors and/or capacitors connected to the hot input. A metal

shield model AC1118 is also available for complete shielding of the circuitry. Where the hot input terminals must be connected to a signal source outside the shield, a coaxial cable with a graphite coating between insulation and braid should be used. This type is required to minimize the generation of noise currents due to any changes in the relative position of shield and conductor. Amphenol type 21-537 is suitable.

Changes in capacity across a high-impedance voltage source cause voltage fluctuations. For this reason, wiring should be rigid, as short as possible, and spaced as far from other objects as possible. Similarly, current fluctuations result from the motion of a conductor in an electrostatic field. The same precautions are effective.

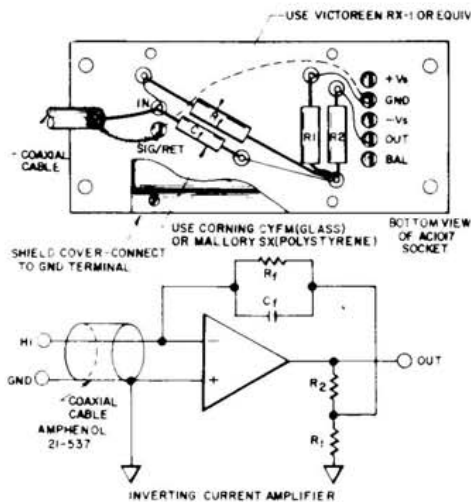

Connection Diagram for Model 310
Used with AC1017 Socket

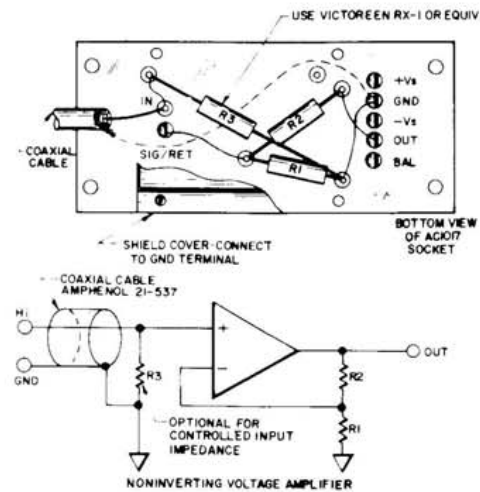

Connection Diagram for Model 311
Used with AC1017 Socket

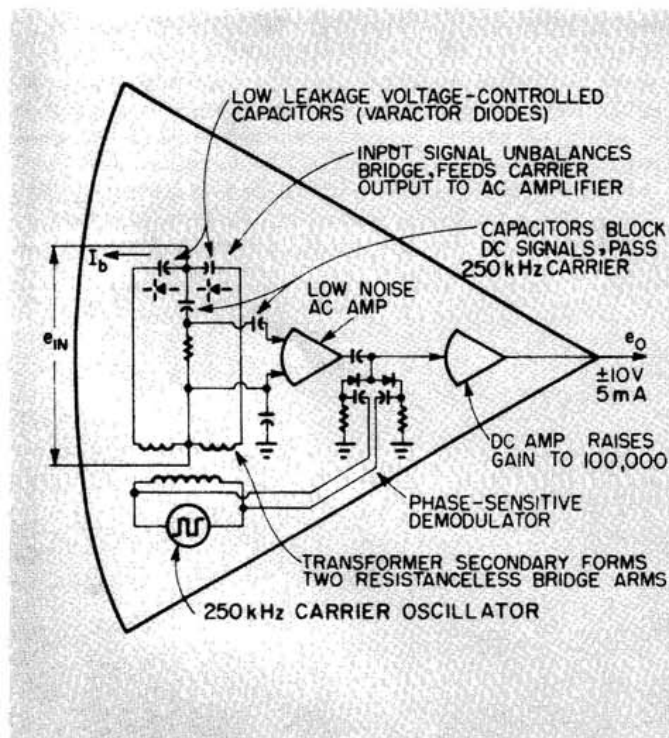

HOW VARACTOR BRIDGE AMPLIFIERS WORK

Amplifier input, e_{IN} , varies varactor capacitances, unbalances bridge, and develops pump voltage output proportional to bridge unbalance.

After low noise AC amplification, the output pump voltage is phase-sensitively demodulated to restore correct polarity, then further boosted by the DC amplifier.

Final output is a replica of the original signal, amplified by the open loop gain.

Matched low leakage varactors inherently eliminate $1/f$ noise, give excellent offset and drift specs, and provide 3×10^{11} ohms differential input impedance. Transformer coupling is responsible for the amplifier's advanced common mode characteristics.

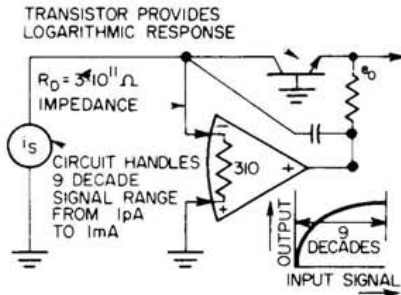

Nine Decade Logarithmic Amplifier

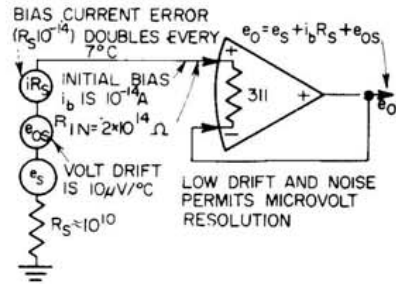

Ultra High Impedance Buffer

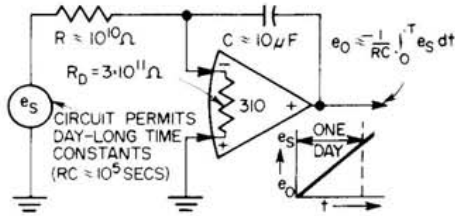

Long Term Integrator

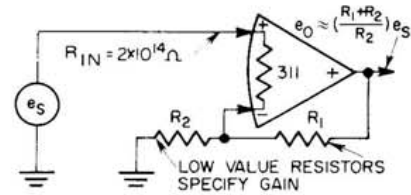

High Impedance Noninverting Amplifier

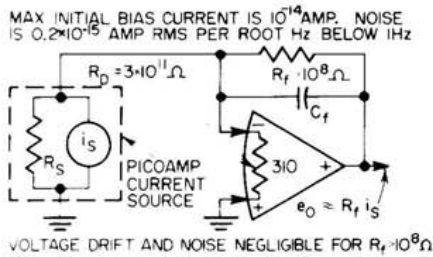

Ultra Sensitive Current Amplifier

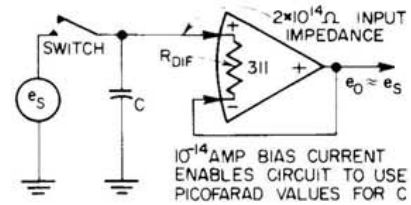

Low Capacitance Sample-and-Hold Amplifier

MODEL 310 (INVERTING)

Applications where the high sensitivity of the 310 as a current amplifier is important include flame detectors, photomultiplier tubes, semiconductor testing, ionization detectors, vacuum gauges and reactor controls. The low bias current of the 310 is also useful in long term, high accuracy integrators or as a nine decade logarithmic amplifier.

MODEL 311 (NONINVERTING)

The model 311 is primarily useful as a high input impedance voltage follower for unloading high source impedances. Typical applications are sample-and-hold and pH amplifiers and/or measuring other chemical reactions.

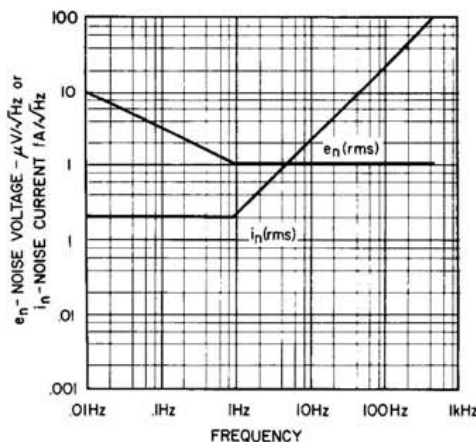

Calculated Noise Per Root Hertz