



## Quick Reference Guide AMP CT Connector Series

The AMP CT connectors are a miniature wire-to-board and wire-to-wire interconnect solution. The AMP CT connector series has proven performance in its harness making capability. A variety of harness-making machines are available ranging from hand tools for low volume production to high-speed automatic crimping machines for medium to high volume productions. AMP high-speed automatic crimping machines are easy to operate, eliminating the need for tedious work of changing parts inside the equipment to adapt to changes in harness styles. Two types of housings are available, including Crimp and Mass Terminated (MT), which are preloaded with insulation displacement contacts. The Box or shrouded headers are highly resistant to scooping at mating/unmating.

### FEATURES AND BENEFITS

- 2 kinds of termination method: IDC, Crimp
- Discrete wire interconnect
- Circuits range from 2-30
- AWG 22-30
- Kinks for self-retention on boards
- RoHS compliant
- Recognized under the component program of Underwriters Laboratories Inc., file No. E28476
- Certified by Canadian Standards Association, File No. LR 7189-133

### PRODUCT APPLICATIONS

- Business Equipment
- Industrial Machines
- PC
- Printer
- Fax
- C-TV
- Audio
- Air conditioner
- Anywhere where signals or power are routed

### How to select an AMP CT connector part number

The charts on this page highlight the relationship between the number of contacts (positions) to the part number. Please see the sample chart below that was designed to help you select the correct part number for your needs. For single digit position to dash numbers, attach the digit to the end base number. For double digit position to dash numbers, attach the first digit to the front of the part number, add a dash and the base part number, then follow the base part number with a dash and the second digit.

Example Base Part Number	Your Criteria	Example Position to Dash Selection	Position					End Part Number Based on Criteria
			8	9	10	11	12	
173977	You require and 8 position MT housing	Dash Number	-8	-9	-10	-11	-12	173977-8
173977	You require and 12 position MT housing	Dash Number	-8	-9	-10	-11	-12	1-173977-2

### Cable Side Connectors

#### Mass Termination (MT) vs. Crimp Poke

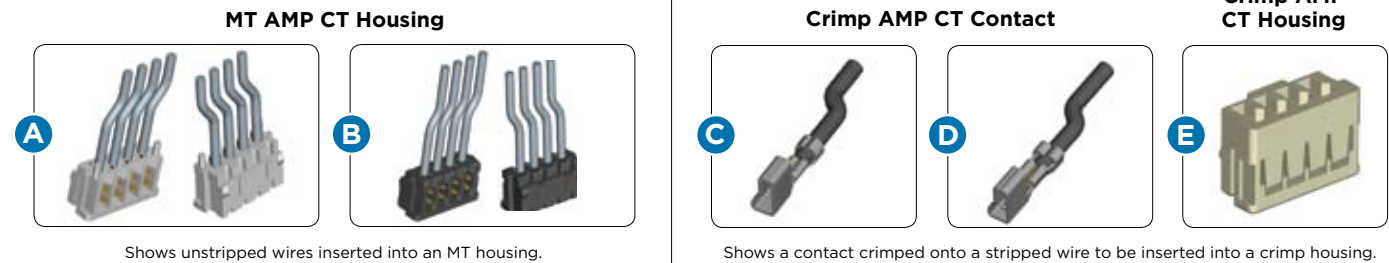

CRIMP TYPE CONNECTORS : Contacts				
Description	PN	Photo	Specifications	
Receptacle Contact - Strip - AWG : 26-30	179609-1	C	D,Y	
Receptacle Contact - Loose Piece - AWG : 26-30	179610-1	C	D,Y	
Receptacle Contact - Strip - AWG : 22-26	179227-1	D	D,Y	
Receptacle Contact - Strip - AWG : 22-26 - Gold plated	179227-4	D	D,Y	
Receptacle Contact - Loose Piece - AWG : 22-26 - receptacle	179518-1	D	D,Y	

CRIMP TYPE CONNECTORS : Housing																
Description	PN	Photo	Position to Dash													
			2	3	4	5	6	7	8	9	10	11	12	13	14	15
Receptacle Housing	179228	E	-2	-3	-4	-5	-4	-7	-8	-9	-10	-11	-12	-13	-14	-15
Mating PNS : 292253; 292161; 292250; 292164; 292133; 292132; 292165; 292173; 292171; 292172; 292134; 176394; 292138; 292252; 292141; 292254; 292156; 292204; 292177; 292178; 292185; 292182; 292181																
Specifications : D,Y																

MASS TERMINATION (MT) CONNECTORS : Pre-Loaded Receptacle Housing																
Description	PN	Photo	Position to Dash													
			2	3	4	5	6	7	8	9	10	11	12	13	14	15
MT receptacle housing (wire application) = AWG : 26-28	173977	A	-2	-3	-4	-5	-4	-7	-8	-9	-10	-11	-12	-13	-14	-15
MT receptacle housing (wire application) = AWG : 24	179694	B	-2	-3	-4	-5	-4	-7	-8	-9	-10	-11	-12	-13	-14	-15
Mating PNS : 292253; 292161; 292250; 292164; 292133; 292132; 292165; 292173; 292171; 292172; 292138; 292252; 292141; 292254; 292156; 292204; 292178; 292182; 175133; 179608																
Specifications : C,X																
MT Receptacle Housing - Au Plated (Wire Application) = AWG: 26~28	176392	A	-2	-3	-4	-5	-4	-7	-8	-9	-10	-11	-12	-13	-14	-15
Mating PNS : 292134; 176394																
Specifications : C,X																

### Cable Side Connectors : Tooling Options

APPLICATION TOOLING			
Connector PN	Tooling PN	Description	Application Spec.
1385047-3*	1385047-3*	Applicator	408-8040
1739772-2 thru -15	58074-1	Manual Handle without head	408-6790
	58372-1	2 mm AMP CT (IDC) Head	408-9426
176392-2 thru -15	58473-2	AMP CT MT Mini Air Terminator	-
179610-1	1385047-3*	Applicator	408-8040
179227-1	680216-3*	Applicator	408-8040
179227-4	680216-3*	Applicator	408-8040
179518-1	91572-1**	CERTI-CRIMP Hand Tool	408-8547

\* Applicators listed are used in the AMP-O-ELECTRIC Model G, AMP 3K/40 and AMP 5K/40 Terminators. Call the Tooling Assistance Center at 800-722-1111 for applicator numbers for Automatic Cut, Strip and Terminate Leadmakers.  
 \*\* Power tooling options are also available. Call Tooling Sales at 888-777-5917 (717-810-2080) for more information

PCB Side Connectors (Single Row + Dual Row)

Common AMP CT Terminology

Locating Boss

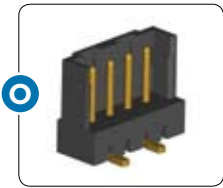
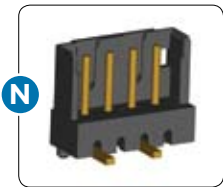

A boss is a mechanical feature that helps orientate the headers onto the PCB.

Without Kinked Leg

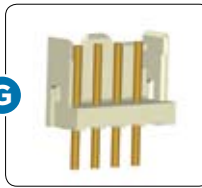
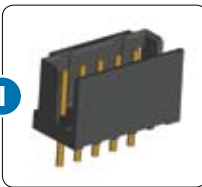

Kinked legs are designed to secure the T/H headers onto the PCB.

With Kinked Leg



Solder Tabs

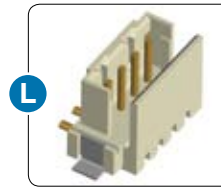
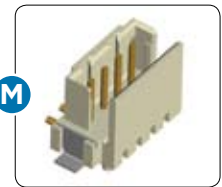

Solder tabs are designed to secure the SMT headers onto the PCB.

Mount Styles

Header Styles

Card Edge



Box

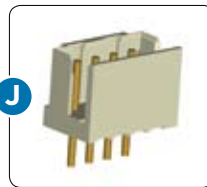

Box headers offer a front and back wall for polarization of the connector.

Standard

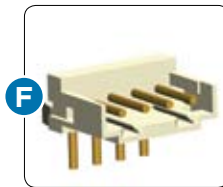

Standard headers offer only a single wall for polarization of the connector.

Dual Row Assemblies

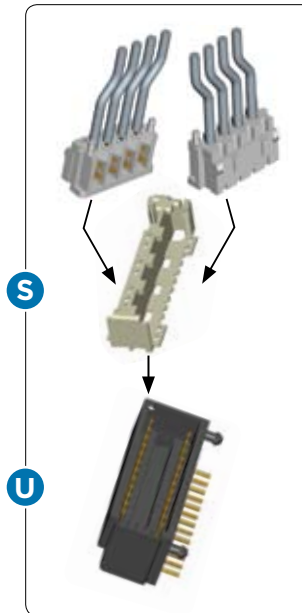

Two Single Row Housings

Captivating Holder

Dual Row Header

Requires a holder to be used along with two single row housings.

Free Hanging



Panel Mount

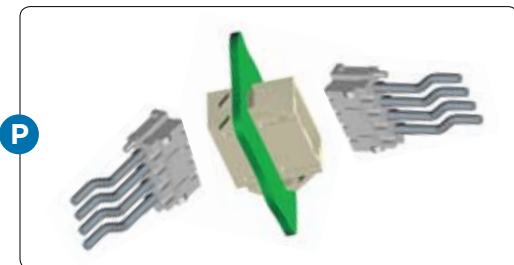

Additional Parts

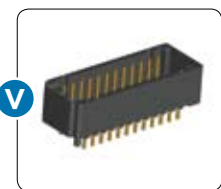

SINGLE ROW POST HEADER ASSEMBLIES BOARD-MOUNT																	
Description	Plating	PN	Photo	Position to Dash													
				2	3	4	5	6	7	8	9	10	11	12	13	14	15
TH Std Type - Horizontal Mount w/ Kink	TIN	292253	F	-2	-3	-4	-5	-6	-7	-8	-9	-10	-11	-12	-13	-14	-15
TH Std Type - Vertical Mount w/ Kink	TIN	292161	G	-2	-3	-4	-5	-6	-7	-8	-9	-10	-11	-12	-13	-14	-15
TH Box Type - Horizontal Mount w/ Kink	TIN	292250	H	-2	-3	-4	-5	-6	-7	-8	-9	-10	-11	-12	-13	-14	-15
TH Box Type - Vertical Mount w/o Kink	TIN	292133	I	-2	-3	-4	-5	-6	-7	-8	-9	-10	-11	-12	-13	-14	-15
TH Box Type - Vertical Mount w/ Kink	TIN	292132	J	-2	-3	-4	-5	-6	-7	-8	-9	-10	-11	-12	-13	-14	-15
SMT Box Type - Horizontal Mount Type w/ Solder Tab, w/o Boss	TIN	292173	K	-22	-23	-24	-25	-26	-27	-28	-29						
SMT Box Type - Horizontal Mount Type w/ Solder Tab, w/ Boss	TIN	292173	K	-2	-3	-4	-5	-6	-7	-8	-9						
SMT Box Type - Vertical Mount Type w/ Solder Tab, w/o Boss	TIN	292175	L	-22	-23	-24	-25	-26	-27	-28	-29						
SMT Box Type - Vertical Mount Type w/ Solder Tab, w/ Boss (Natural)	TIN	292174	M	-2	-3	-4	-5	-6	-7	-8	-9						
SMT Box Type - Vertical Mount Type w/ Solder Tab, w/ Boss (Black)	TIN	292174	M	-22	-23	-24	-25	-26	-27	-28	-29						
SMT Std Type - Vertical Mount w/ Boss	TIN	292171	N	-2	-3	-4	-5	-6	-7	-8	-9						
SMT Std Type - Vertical Mount w/o Boss	TIN	292172	O	-2	-3	-4	-5	-6	-7	-8	-9						
Mating PNS : (MT) 173977; 179694 or (Crimp) 179228 w/ contact Specifications : A, D																	
TH Box Type - Vertical Mount w/ Kink	Gold	292134	J	-2	-3	-4	-5	-6			-9	-10		-12			-15
TH Box Type - Horizontal Mount w/ Kink	Gold	176394	H	-2		-4		-6		-8		-10					
Mating PNS : (MT) 173977; 179694 or (Crimp) 179228 w/ 179227-4 Specifications : A (292134)/ C (176394), D																	

RECEPTACLE CONNECTOR HOLDERS FOR DUAL ROW HEADERS																	
Description	PN	Photo	Position to Dash														
			8	12	16	18	20	22	24	26	28	30					
Receptacle Housing Captivating Holder (MT)	175133	R	-8	-12	-16	-18	-20	-22	-24	-26	-28	-30					
Receptacle Housing Captivating Holder - Reinforced Retention (MT)	179608	S			-16	-18	-20	-22	-24	-26	-28	-30					
Mating PNS : 2x (MT) 173977, 176392 or 179695 Specifications : B																	
Receptacle Housing Captivating Holder - Reinforced Retention (Crimp)	179472	T	-8	-12	-16	-18	-20	-22	-24	-26	-28	-30					
Mating PNS: 2 x (Crimp) 179228 w/ contact Specifications : B																	

DUAL ROW POST HEADER ASSEMBLIES - BOARD-MOUNT																	
Description	PN	Photo	Position to Dash														
			8	12	16	18	20	22	24	26	28	30					
Horizontal Mount w/ Boardlocks	292138	U	-8	-12	-16	-18	-20	-22	-24	-26	-28	-30					
Vertical Mount w/o Boss	292252	V			-16	-18	-20	-22	-24	-26	-28	-30					
Vertical Mount w/ Boss	292141	V			-16	-18	-20	-22	-24	-26	-28	-30					
Complementary PNS : 175133, 179608 or 179472 w/ 2 x (MT) or 2 x (Crimp) HDRS Specifications : B																	

CARD-EDGE CONNECTORS																	
Description	PN	Photo	Position to Dash														
			2	3	4	5	6	7	8	9	10						
AMP CT Card-Edge Connector	292204	W					-1		-2								
Specifications : E																	

SINGLE ROW PANEL-MOUNT HEADERS																	
Description	PN	Photo	Position to Dash														
			2	3	4	5	6	7	8	9	10	11	12	13	14	15	
Panel Mount Header	292254	P	-2	-3	-4	-5	-6	-7	-8	-9	-10	-11	-12	-13	-14	-15	
Mating PNS : (MT) 173977; 179694 or (Crimp) 179228 w/ contact Specifications : A,D																	

SINGLE ROW POST FREE-HANGING WIRE TO WIRE HEADERS																	
Description	PN	Photo	Position to Dash														
			2	3	4	5	6	7	8	9	10	11	12	13	14	15	
Free Hanging Header	292156	Q	-2	-3	-4	-5	-6										
Mating PNS : (MT) 173977; 179694 or (Crimp) 179228 w/ contact Specifications : A,D																	

# AMP CT Connector Series

## Product/Application Specification

RATINGS							
Product Specs		Voltage	22 AWG	24 AWG	26 AWG	28 AWG	30 AWG
A	108-60016	125 V (AC/DC)		3	2	1	
B	108-60020	125 V (AC/DC)			1	1	
C	108-5218	125 V AC		3	2	1	
D	108-60029	125 V AC	4	3	2.5	1.5	1
E	108-60024	125 V AC			1		
F	108-60021	125 V AC			1		

Application Specs	
X	114-5014
Y	114-5179
Z	114-5103

## AMP CT Mount Styles

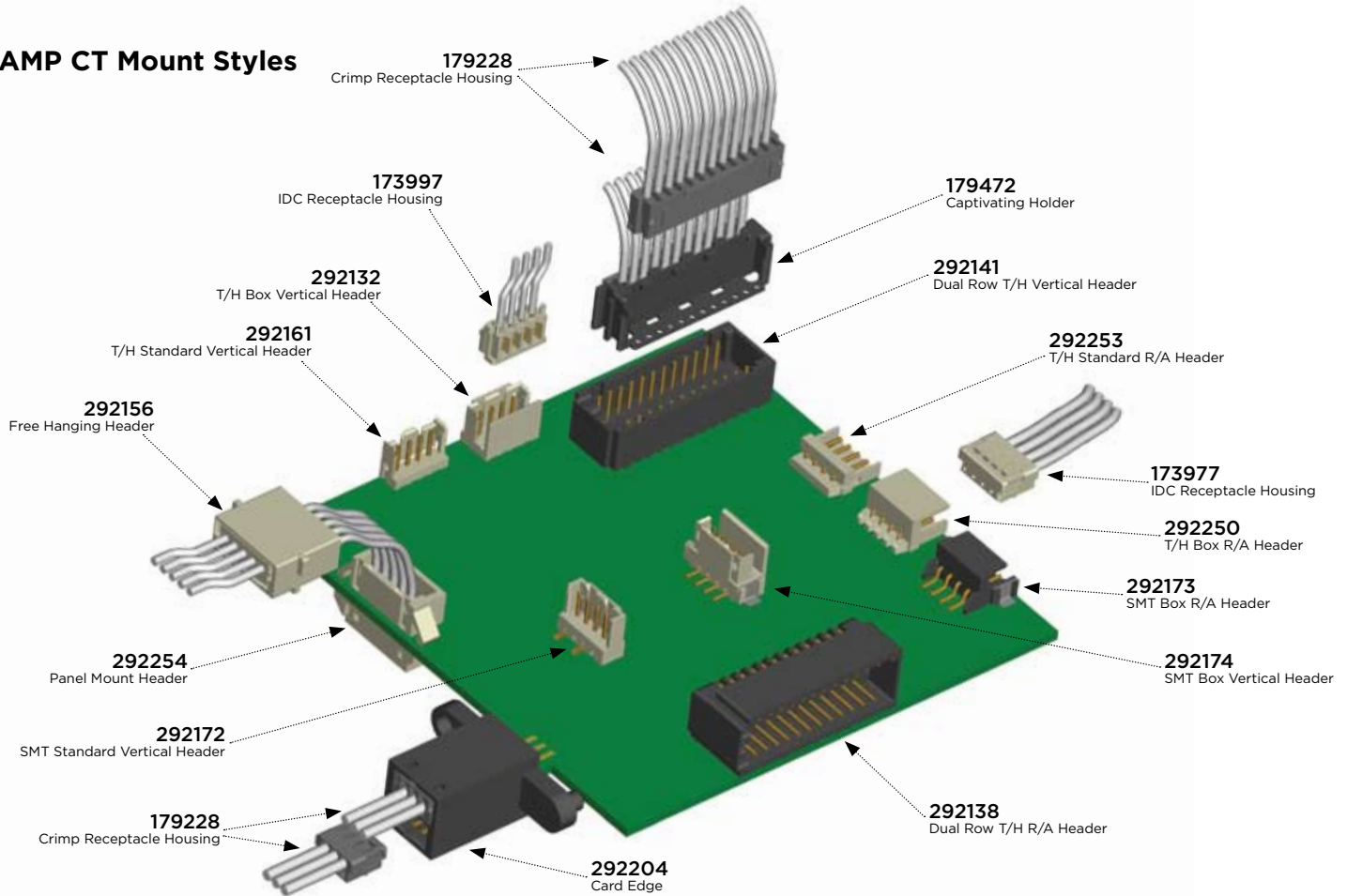

## Waldom CT Design Kits\*

Waldom CT Design Kits	
PN	Description
2110829-1	AMP CT Deluxe Kit
2110829-2	AMP CT R/A Header
2110829-3	AMP CT Vertical Header
2110829-4	AMP CT R/A Box Header
2110829-5	AMP CT Box Vertical Header
2110829-6	AMP CT Panel Mount
2110829-7	AMP CT Dual Row R/A Header
2110829-8	AMP CT Dual Row Vertical Header

\*Design kits are designed and assembled by Waldom and are available for purchase through your local distribution channel.



## Questions to ask at Design In stage

**What wire gauge will you be using?** More flexibility with AWG when using Crimp vs. MT. Crimp housings accept 22-30 AWG and MT housings accept 24-28 AWG.

**Are the connectors available for IDC?** Yes, we offer a MT version that is preloaded with IDC contacts.

**Is your process automated?** MT housings are more suitable for automated processes.

**Where can I find information on current rating, voltage and operating temperatures?** Please see Product Specification Information on page 4 of this QRG.

**Which is a more standard header, with or without a locating boss?** The most standard headers tend to have a locating boss as it makes it easier for the customer to align the connector onto their board.

**What special retention mechanisms are available to help ensure PCB stability?** Most of the T/H headers have kinked legs, and the SMT headers have solder tabs to help ensure PCB stability.

**What are my tooling options?** Tyco Electronics offers comprehensive tooling options including Manual Pistol-Grips, manual Mini-Press, Pneumatic Mini-press, Semi-Auto DECAM and an Automatic DECAM tool. For more information, please visit [tooling.tycoelectronics.com](http://tooling.tycoelectronics.com)

**What is the benefit of choosing Box over Std type headers?** Box type headers have an extra wall, that is a more reliable connector design intended to prevent stubbing.

## e-Catalog

[www.tycoelectronic.com/products/ct](http://www.tycoelectronic.com/products/ct)

Breakdown from main page :

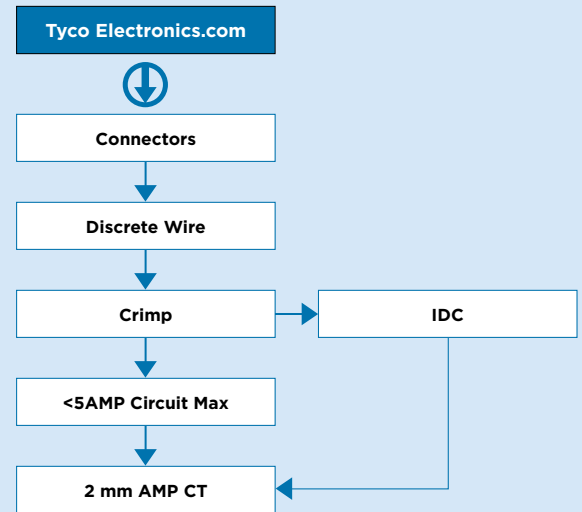

## FOR MORE INFORMATION

### Technical Support

Internet:	<a href="http://www.tycoelectronics.com/help">www.tycoelectronics.com/help</a>
USA:	+1 (800) 522-6752
Canada:	+1 (905) 470-4425
Mexico & Central America:	+52(0) 55-1106-0814
South America:	+55 (0) 11-2103-6000
Germany:	+49 (0) 6251-133-1999
UK:	+44 (0) 8706-080208
France:	+33 (0) 1-3420-8686
Netherlands:	+31 (0) 73-6246-999
China:	+86 (0) 400-820-6015

Part numbers in this brochure are RoHS Compliant\*, unless marked otherwise.

\*as defined [www.tycoelectronics.com/leadfree](http://www.tycoelectronics.com/leadfree)

**Tyco Electronics Corporation, Harrisburg, PA**

**[tycoelectronics.com](http://tycoelectronics.com)**

© 2009 Tyco Electronics Corporation. All Rights Reserved.

1-1773455-8 CIS FP 1M 09/2009

AMP, AMP 3K/40, AMP 3K/50, AMP-O-LECTRIC, DECAM, TE (logo) and Tyco Electronics are trademarks of the Tyco Electronics group of companies and its licensors.

Other products, logos, and Company names mentioned herein may be trademarks of their respective owners.

While Tyco Electronics has made every reasonable effort to ensure the accuracy of the information in this catalog, Tyco Electronics does not guarantee that it is error-free, nor does Tyco Electronics make any other representation, warranty or guarantee that the information is accurate, correct, reliable or current. Tyco Electronics reserves the right to make any adjustments to the information contained herein at any time without notice. Tyco Electronics expressly disclaims all implied warranties regarding the information contained herein, including, but not limited to, any implied warranties of merchantability or fitness for a particular purpose. The dimensions in this catalog are for reference purposes only and are subject to change without notice. Specifications are subject to change without notice. Consult Tyco Electronics for the latest dimensions and design specifications.

 **Tyco Electronics**  
Our commitment. Your advantage.