

Contact arrangement

19 CONTACTS

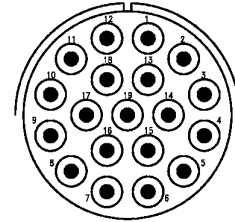
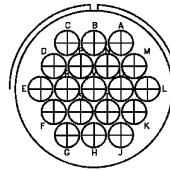
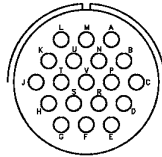
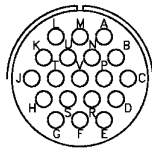

ARRANGEMENT 20-A48
CONTACT SIZE 16
SERVICE RATING I

ARRANGEMENT 22-14
CONTACT SIZE 16
SERVICE RATING A

ARRANGEMENT 24-67
CONTACT SIZE 12
SERVICE RATING A

ARRANGEMENT 40-B19
CONTACT SIZE 8
SERVICE RATING A

20 CONTACTS

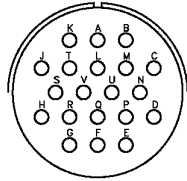

ARRANGEMENT 28-16
CONTACT SIZE 16
SERVICE RATING A

22 CONTACTS

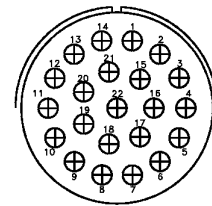
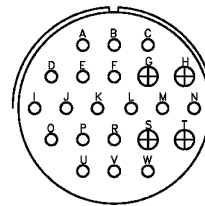
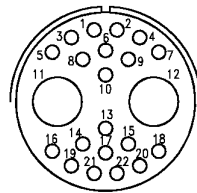
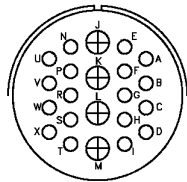

ARRANGEMENT 28-11
CONTACT SIZE 4/12, 18/16
SERVICE RATING A

ARRANGEMENT 32-B22
CONTACT SIZE 2/4, 20/16
SERVICE RATING A

ARRANGEMENT 36-1
CONTACT SIZE 4/12, 18/16
SERVICE RATING D

ARRANGEMENT 36-22
CONTACT SIZE 12
SERVICE RATING D

23 CONTACTS

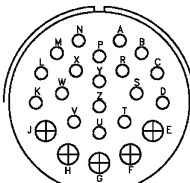
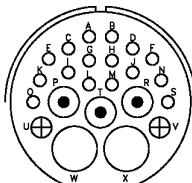

24 CONTACTS

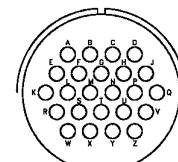

ARRANGEMENT 32-6
CONTACT SIZE 2/4, 3/8, 2/12, 16/16
SERVICE RATING A

ARRANGEMENT 32-13
CONTACT SIZE 5/12, 18/16
SERVICE RATING D

ARRANGEMENT 24-28
CONTACT SIZE 16
SERVICE RATING I

25 CONTACTS

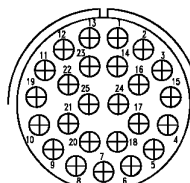
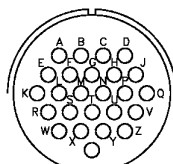

26 CONTACTS

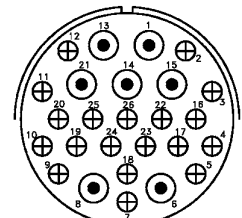
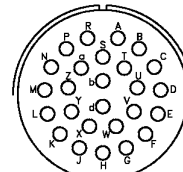

ARRANGEMENT 24-A25
CONTACT SIZE 16
SERVICE RATING A

ARRANGEMENT 32-A25
CONTACT SIZE 12
SERVICE RATING A

ARRANGEMENT 28-12
CONTACT SIZE 16
SERVICE RATING A

ARRANGEMENT 40-26
CONTACT SIZE 7/8, 19/12
SERVICE RATING A

CONTACT LEGEND

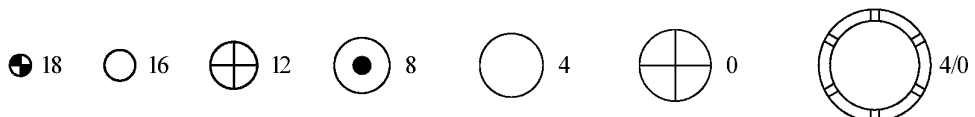

CM1 3106 F
CM1 4106 F
Straight plug

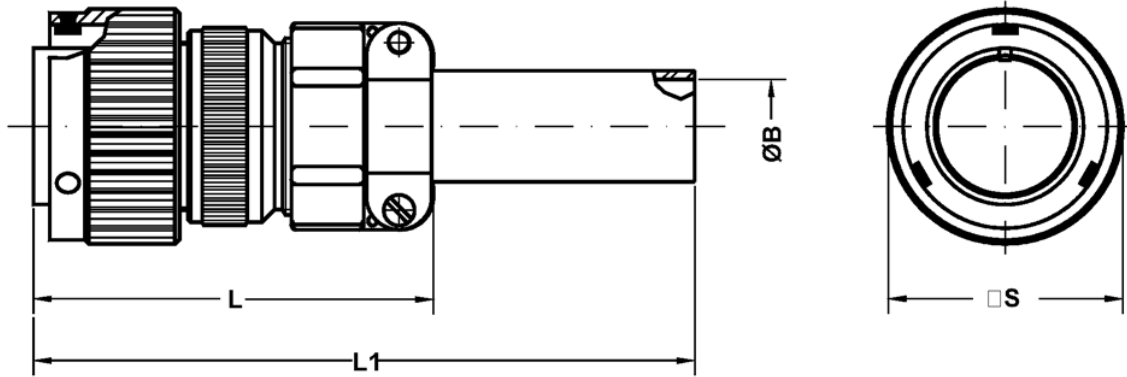

Shell size	ØB ±0.1	L Max.	L1 Max.	ØQ ±0.2
10 SL	5.58	55.0	125	22.6
14 S	7.92	58.4	125	29.0
16 S	11.09	60.4	125	31.6
16	11.09	71.8	135	31.6
18	14.27	77.8	140	36.2
20	15.87	74.0	130	39.8
22	15.87	74.0	130	43.0
24	19.05	76.7	130	46.4
28	19.05	83.2	135	53.0
32	23.79	90.3	140	60.0
36	31.75	96.8	145	66.2
40	34.92	115.8	160	72.3

Straight plug.
Includes insulating grommet, backshell,
class A **CM3057** cable clamp and neoprene
sleeve.
No grommet supplied.

HOW TO ORDER

<u>FR</u>	<u>CM1</u>	<u>31</u>	<u>06</u>	<u>A</u>	<u>20-27</u>	<u>P</u>	<u>X</u>	<u>(...)</u>
<i>1</i>	<i>2</i>	<i>3</i>	<i>4</i>	<i>5</i>	<i>6</i>	<i>7</i>	<i>8</i>	<i>9</i>

- 1* Omitted : Standard
FR : Fire Resistant rubber
- 2* CM1 : Bayonet coupling
*CM4 : Bayonet coupling without stainless steel wear pins
- 3* 31 : Solder contacts
41 : Crimp contacts
- 4* Style : 00 - 01 - 02 - 03 - 030 - 05 - 06 - 07 - 070 - 078 - 08 - 26
- 5* Class : A - F - G - GR - RS - SP - Y
- 6* Contact arrangement
- 7* P : Pin contacts
S : Socket contacts
P/S : Contacts for 02PP connectors
- 8* W - X - Y - Z : Alternate positions of the inserts
- 9* Modifications (see the next page)

* Only for receptacles

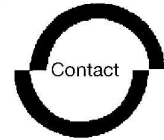

Technical characteristics

Metal parts

Aluminium alloy with Cadmium free surface coatings with an olive drab passivation .

Contacts

The following contact types are available : copper alloy with silver plating (Std) or gold plating (available on request).

Insulating parts

High insulation synthetic rubber resistant to oils and high range of temperatures (-55°C to +125°C) in accordance with MIL-R-3065. Are also available in fire resistant and halogen free materials.

Contacts

Contact size	Rated current at 20°C	Max. Contact resist.	Wire size
18	7.5 A	12.0 mΩ	20÷26 AWG
16	22 A	6.0 mΩ	16÷22 AWG
12	41 A	3.0 mΩ	12-14 AWG
8	73 A	1.0 mΩ	8-10 AWG
4	135 A	0.5 mΩ	4-6 AWG
0	245 A	0.3 mΩ	0÷2 AWG
4/0	350 A	0.2 mΩ	4/0 AWG

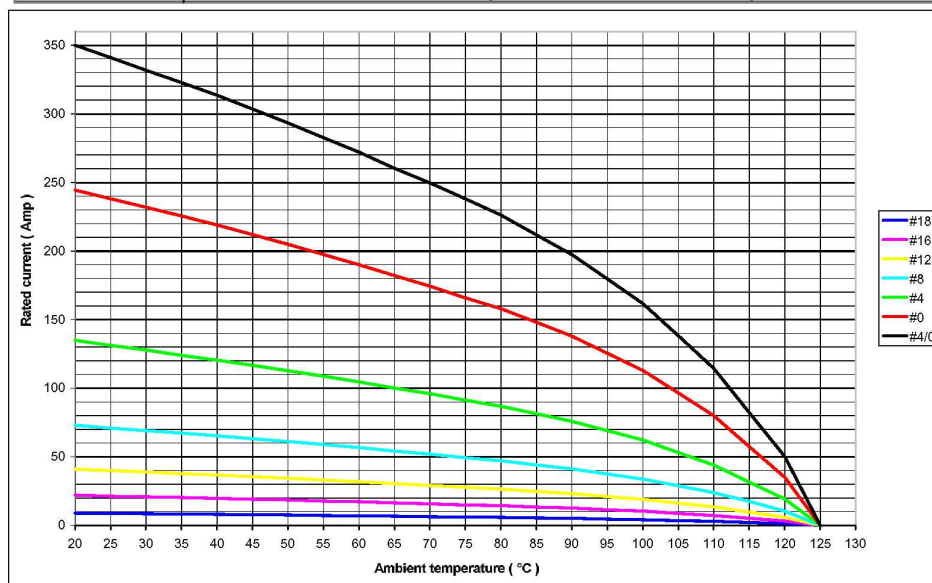

Service rating (Min insulating resistance : $\geq 5 \times 10^3 \text{ M}\Omega$)

Class	Operating voltage Vdc	Operating voltage VacRMS	Test voltage Vac RMS
INST.	250 V	200 V	1000 V
A	700 V	500 V	2000 V
D	1250 V	900 V	2800 V
E	1750 V	1250 V	3500 V
B	2450 V	1750 V	4500 V
C	4200 V	3000 V	7000 V