

Contact arrangement

10 CONTACTS

ARRANGEMENT  
CONTACT SIZE  
SERVICE RATING

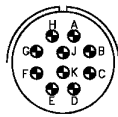

16-A10  
18  
I

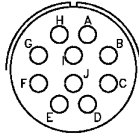

18-1  
16  
B,C,E,G=A ;  
Bal=I

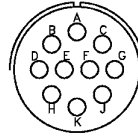

18-19  
16  
A

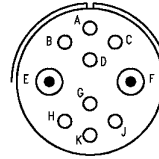

22-82  
8/16 , 2/8  
A

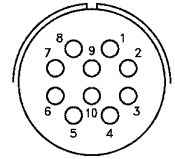

22-A10  
16  
A

ARRANGEMENT  
CONTACT SIZE  
SERVICE RATING

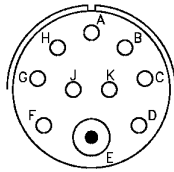

24-21  
1/8 , 9/16  
D

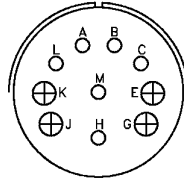

28-19  
4/12 , 6/16  
A,B=D ; K,M=B ; Bal=A

11 CONTACTS

ARRANGEMENT  
CONTACT SIZE  
SERVICE RATING

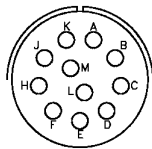

20-33  
16  
A

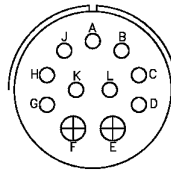

24-20  
2/12 , 9/16  
D

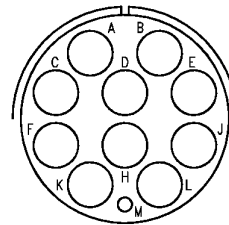

40-67  
10/4 , 1/16  
A

12 CONTACTS

ARRANGEMENT  
CONTACT SIZE  
SERVICE RATING

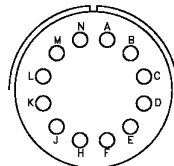

24-19  
16  
A

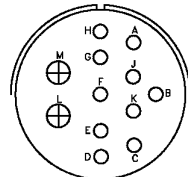

28-8  
2/12 , 10/16  
B=D ; L,M=E ; Bal=A

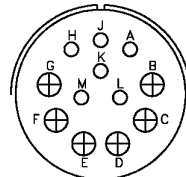

28-9  
6/12 , 6/16  
D

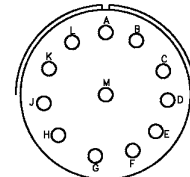

28-18  
16  
A,B=A ; G,H,J,K,L=D ;  
M=C ; Bal=I

13 CONTACTS

ARRANGEMENT  
CONTACT SIZE  
SERVICE RATING

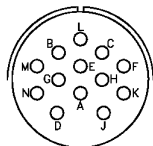

20-11  
16  
I

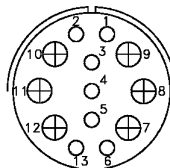

24-013  
6/12 , 7/16  
A

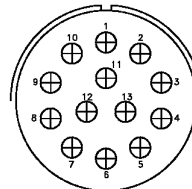

32-013  
12  
D

CONTACT LEGEND

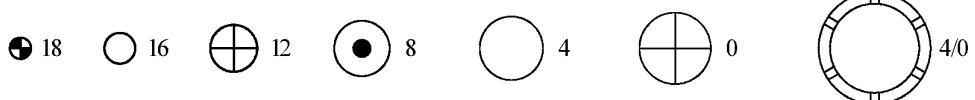

**CM1 3106 F**  
**CM1 4106 F**  
**Straight plug**

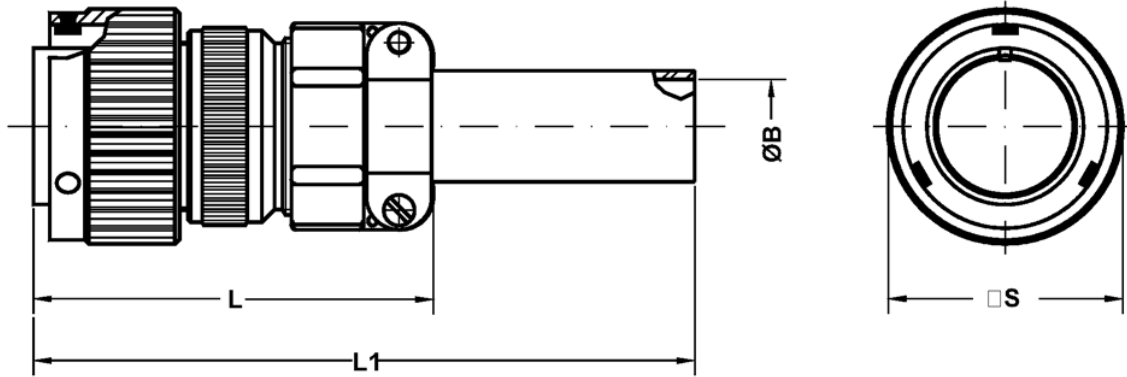

Shell size	ØB ±0.1	L Max.	L1 Max.	ØQ ±0.2
10 SL	5.58	55.0	125	22.6
14 S	7.92	58.4	125	29.0
16 S	11.09	60.4	125	31.6
16	11.09	71.8	135	31.6
18	14.27	77.8	140	36.2
20	15.87	74.0	130	39.8
22	15.87	74.0	130	43.0
24	19.05	76.7	130	46.4
28	19.05	83.2	135	53.0
32	23.79	90.3	140	60.0
36	31.75	96.8	145	66.2
40	34.92	115.8	160	72.3

Straight plug.  
Includes insulating grommet, backshell,  
class A **CM3057** cable clamp and neoprene  
sleeve.  
No grommet supplied.

## HOW TO ORDER

<b>FR</b>	<b>CM1</b>	<b>31</b>	<b>06</b>	<b>A</b>	<b>20-27</b>	<b>P</b>	<b>X</b>	<b>(...)</b>
<i>1</i>	<i>2</i>	<i>3</i>	<i>4</i>	<i>5</i>	<i>6</i>	<i>7</i>	<i>8</i>	<i>9</i>

- 1* Omitted : Standard  
FR : Fire Resistant rubber
- 2* CM1 : Bayonet coupling  
\*CM4 : Bayonet coupling without stainless steel wear pins
- 3* 31 : Solder contacts  
41 : Crimp contacts
- 4* Style : 00 - 01 - 02 - 03 - 030 - 05 - 06 - 07 - 070 - 078 - 08 - 26
- 5* Class : A - F - G - GR - RS - SP - Y
- 6* Contact arrangement
- 7* P : Pin contacts  
S : Socket contacts  
P/S : Contacts for 02PP connectors
- 8* W - X - Y - Z : Alternate positions of the inserts
- 9* Modifications (see the next page)

\* Only for receptacles

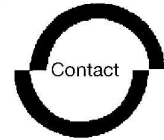

## Technical characteristics

### Metal parts

Aluminium alloy with Cadmium free surface coatings with an olive drab passivation .

### Contacts

The following contact types are available : copper alloy with silver plating (Std) or gold plating (available on request).

### Insulating parts

High insulation synthetic rubber resistant to oils and high range of temperatures (-55°C to +125°C) in accordance with MIL-R-3065. Are also available in fire resistant and halogen free materials.

### Contacts

Contact size	Rated current at 20°C	Max. Contact resist.	Wire size
18	7.5 A	12.0 mΩ	20÷26 AWG
16	22 A	6.0 mΩ	16÷22 AWG
12	41 A	3.0 mΩ	12-14 AWG
8	73 A	1.0 mΩ	8-10 AWG
4	135 A	0.5 mΩ	4-6 AWG
0	245 A	0.3 mΩ	0÷2 AWG
4/0	350 A	0.2 mΩ	4/0 AWG

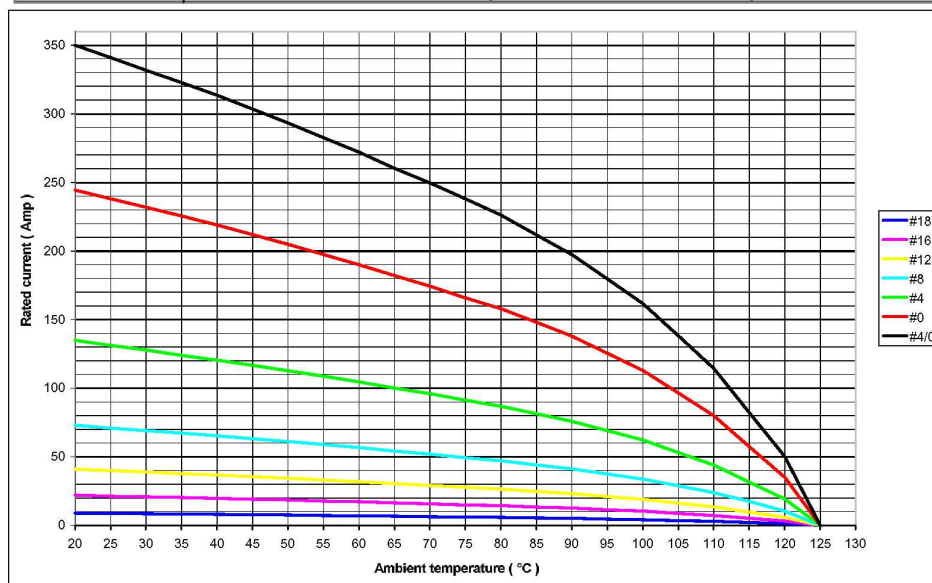

### Service rating (Min insulating resistance : $\geq 5 \times 10^3 \text{ M}\Omega$ )

Class	Operating voltage Vdc	Operating voltage VacRMS	Test voltage Vac RMS
INST.	250 V	200 V	1000 V
A	700 V	500 V	2000 V
D	1250 V	900 V	2800 V
E	1750 V	1250 V	3500 V
B	2450 V	1750 V	4500 V
C	4200 V	3000 V	7000 V