



ELWIST 4008 V

Industrial Connectors: Circular connectors E-series M8: with screw locking: MiniQuick, fast connection, cable plug self-assembled

Product description

Description	Angled cable plug, unassembled, strain relief by means of clamping cage
Type	ELWIST 4008 V
Order No.	933 409-100
Type of contact	male
Number of contacts	4
Cable gland	M 9.5 x 1 diameter max. 5.5 mm
Standard	IEC 61076-2-101 (Ed. 1)/ IEC 60947-5-2
Housing Color	black

Drawing

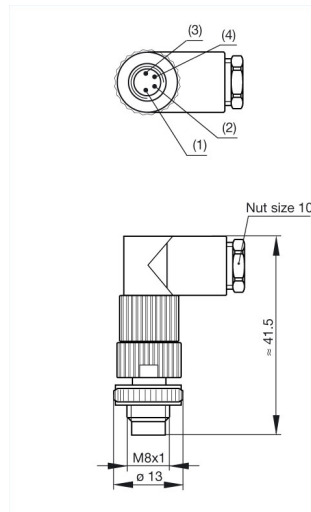

Technical data

Pin dimensions	1 mm
Rated voltage	60 V AC/DC
Rated current	4 A (2 A at 0.14 mm ²)
Type of termination	pin penetration
Suitable cables	diameter 4 mm to 5 mm / 0.14 mm ² to 0.34 mm ²
Core insulation of connecting leads	PVC, PETP, diameter 1.0 mm to 1.55 mm

Material

Contact material	Cu Zn
Contact surface material	Au
Contact bearer material	PA
Housing material	PA
Coupling nut material	Zn Al/Ni
O-Ring	Viton / NBR

Environmental conditions

Protection class (IEC 60529)	IP 67
Pollution severity	3
Temperature range	-25 °C to +70 °C
Inflammability class	
Housing	94 V-2
Contact bearer	94 V-2
Packaging unit	
Packaging unit	100 pieces