



Product description

The circular connector series C 16-3 has two housing sizes. The connectors are designed to meet the high requirements of industrial applications under harsh environmental conditions. The range includes versions with screw and crimp terminations. A selection of crimp contacts for hand crimp tools and crimp machines enables a reliable termination relating in qualitative, technical and economical advantages. A board selection of housing styles are available.

Main features and advantages:

- Circular connectors for power and signal applications with following contact arrangements:
Shell size 1: 8 + PE, 14 + PE, 17 + PE , 12 + 3 + PE
Shell size 2: 5 + PE, 12 + PE, 14 + PE, 19 + PE
- For applications in machine tools, measurement and control, process technology and medical equipment
- Housing are made from high grade plastic material.
- Vibration safe connection by solid bayonet coupling with lock in position.
- Cable housing straight or right-angled with various cable outlets
- Protection degree IP 65 in mated position.
- Internal cable clamp or clamping ring provides a safe cable restrain.

C 16-3

Product description
Order information
Approvals

Order information

Colour coding

Upon request the coupling ring of the plugs and the housing of the receptacles can be delivered in the colour red, green, blue, yellow and grey.

Polarization



Depending on the contact arrangements the polarization of this connector series can be varied. The contact inserts can be mounted in alternate positions. The order number in the catalogue refers always to position 1. The position of the contact inserts can also be changed by the customer using a disassembly tool (see page 14 and 17) to remove the insert and remount it in the required position (see page 6)

Crimp version

Order numbers do not include crimp contacts. Please order separately (page 21 / 22)

Crimp tooling

Ask for our catalogue "Tools".

Testhouse	Approvals	Approval No.
VDE		3964
UL		E 63093
CSA		49932-9

In general approvals refer to representative versions of the connector series. Test report upon request.

Polarization

Depending on the contact arrangements the polarization of this connector series can be varied. Please take care of the housing and contact insert characteristics.

Shell size 1			Shell size 2		
No of contacts	No of coding possibil.	Position	No of contacts	No of coding possibil.	Position
8 + PE	4	1, 3, 5, 7	5 + PE	6	1, 2, 3, 4, 6, 7
14 + PE	7	1, 2, 3, 4, 5, 6, 7	14 + PE	7	1, 2, 3, 4, 5, 6, 7
17 + PE	6	1, 2, 3, 4, 5, 7	12 + PE	7	1, 2, 3, 4, 5, 6, 7
12 + 3 + PE	7	1, 2, 3, 4, 5, 6, 7	19 + PE	6	1, 3, 4, 5, 6, 7

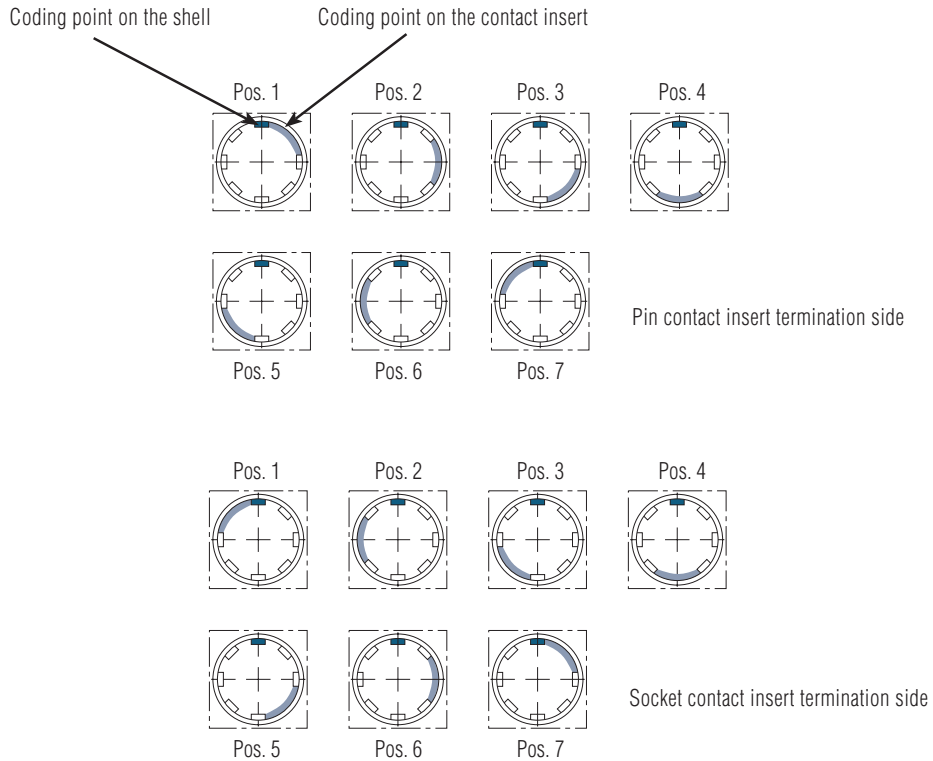



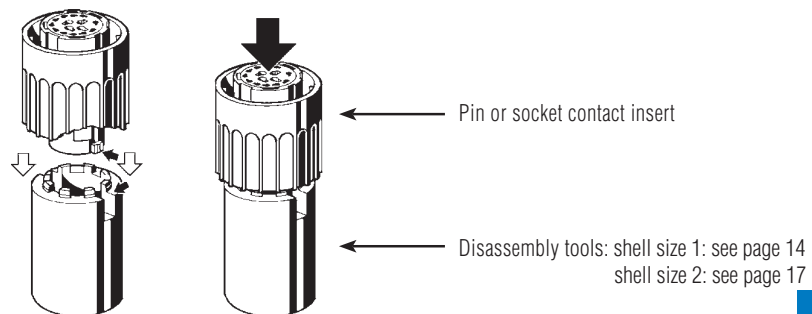

Disassembly of contact inserts with disassembly tool (see page 14 and 17)

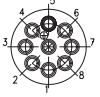

C 16-3

Technical data Shell size 1

General Characteristics	Standard	Technical data			
		Shell size 1			
Number of contacts		8 + PE	14 + PE	17 + PE	12 + 3 + PE ²⁾
					
Electrical Characteristics					
Rated insulation voltage	DIN EN 60664-1 ¹⁾	400 V	100 V	100 V	4 x 320 V 12 x 24 V
Rated impulse withstand voltage	DIN EN 60664-1 ¹⁾	6000 V	3000 V	3000 V	4 x 4000 V 12 x 800 V
Pollution degree	DIN EN 60664-1 ¹⁾	3	3	3	3
Installation (overvoltage) category	DIN EN 60664-1 ¹⁾	III	III	III	III
Material group	DIN EN 60664-1 ¹⁾	II	II	II	II
Current carrying capacity	DIN EN 60512-5-2, test 5b,	12 A	11 x 6 A 4 x 16 A	6 A	4 x 12 A 12 x 6 A
Insulation resistance	DIN EN 60512-3-1, test 3a	$\geq 10^8 \Omega$			
Contact resistance	DIN EN 60512-2-1, test 2a	$\leq 5 \text{ m}\Omega$			
Climatic Characteristics					
Climatic category	DIN EN 60068-1	40 / 125 / 56			40/100/56
Operating temperature		-40°C ... +125°C			
Mechanical Characteristics					
IP-degree of protection	DIN EN 60529	IP 65			
Insertion and withdrawal force	DIN EN 60512-13-2, test 13b	$\leq 25 \text{ N}$	$\leq 30 \text{ N}$	$\leq 22 \text{ N}$	$\leq 25 \text{ N}$
Mechanical operation	DIN EN 60512-9-1, test 9a	≥ 500 mating cycles			
Materials					
Housing material		Polyamide 6.6			
Dielectric material		Polyamide 6.6			
Gasket material		Neoprene			
Contact plating		silver plated / gold plated			
Other Characteristics					
Termination technique		crimp			
Wire gauge / AWG		0,14 - 2,5 mm ² / 26 - 14	0,14 - 2,5 mm ² / 26 - 14	0,14 - 1,0 mm ² / 26 - 18	0,14 - 2,5 mm ² / 26 - 14
Flammability	UL 94	V0			
Locking system		bayonet			
UL	UL 1977	Conditions of acceptability			

¹⁾ DIN 60664-1 Δ VDE 0110-1 Δ DIN EN 60664-1 ²⁾ VDE approval requested







The stated technical values refer to the use as connector.

If these components are used as plug and socket device a reduced current carrying capacity has to be considered.

Index

C 16-3

Technical data Shell size 2

General Characteristics	Standard	Technical data			
		Shell size 2			
Number of contacts		5 + PE	12 + PE	14 + PE	19 + PE
					
Electrical Characteristics					
Rated insulation voltage	DIN EN 60664-1 ¹⁾	400 V	3 x 500 V 9 x 300 V	400 V	250 V
Rated impulse withstand voltage	DIN EN 60664-1 ¹⁾	6000 V	3 x 6000 V 9 x 4000 V	3100 V	4000 V
Pollution degree	DIN EN 60664-1 ¹⁾	3	3	3	3
Installation (overvoltage) category	DIN EN 60664-1 ¹⁾	III	III	III	III
Material group	DIN EN 60664-1 ¹⁾	II	II	II	II
Current carrying capacity	DIN EN 60512-5-2, test 5b,	21 A	3 x 21 A 9 x 11 A	4 x 6 A 11 x 12 A	6 A
Insulation resistance	DIN EN 60512-3-1, test 3a	$\geq 10^8 \Omega$			
Contact resistance	DIN EN 60512-2-1, test 2a	$\leq 5 \text{ m}\Omega$			
Climatic Characteristics					
Climatic category	DIN EN 60068-1	40/100/56	40 / 125 / 56		
Operating temperature		-40°C ... +125°C (5+PE: +100°C)			
Mechanical Characteristics					
IP-degree of protection	DIN EN 60529	IP 65			
Insertion and withdrawal force	DIN EN 60512-13-2, test 13b	$\leq 15 \text{ N}$	$\leq 25 \text{ N}$	$\leq 30 \text{ N}$	$\leq 25 \text{ N}$
Mechanical operation	DIN EN 60512-9-1, test 9a	≥ 500 mating cycles			
Materials					
Housing material		Polyamide 6.6			
Dielectric material		Polyamide 6.6			
Gasket material		Neoprene			
Contact plating		silver plated/gold plated			
Other Characteristics					
Termination technique		screw	crimp		
Wire gauge / AWG		4 mm ² / 10	0,14 - 2,5 mm ² / 26 - 14	0,14 - 2,5 mm ² / 26 - 14	0,14 - 1,0 mm ² / 26 - 18
Flammability	UL 94	V0			
Locking system		bayonet			
UL	UL 1977	Conditions of acceptability			

¹⁾ DIN EN 60664-1 \triangleq VDE 0110-1 \triangleq IEC 60664-1



The stated technical values refer to the use as connector.

If these components are used as plug and socket device a reduced current carrying capacity has to be considered.

C 16-3

Derating curves

Shell size 1

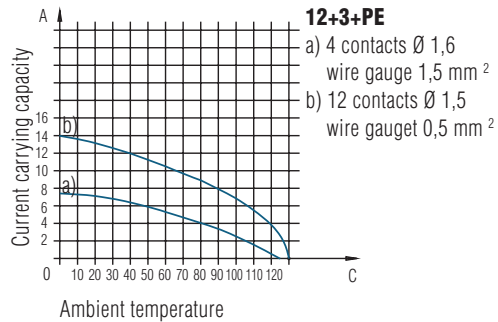
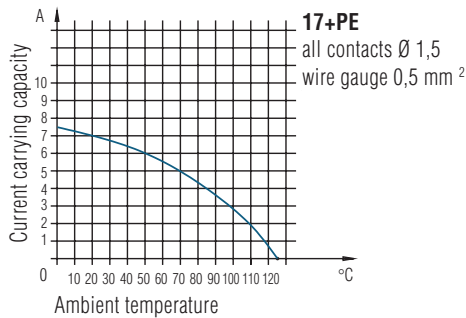
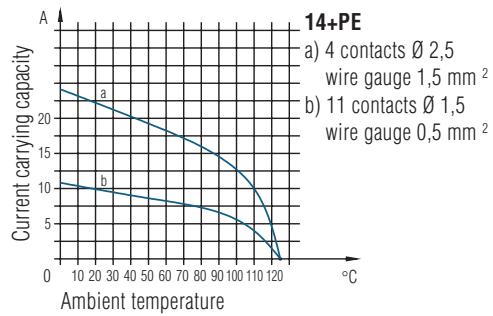
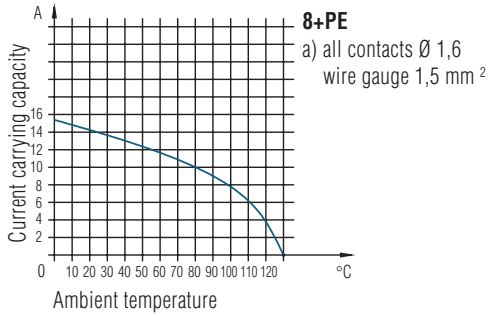

Shell size 2

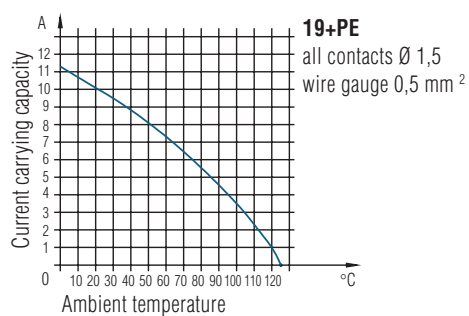
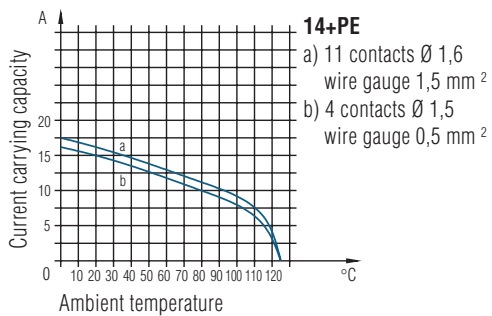
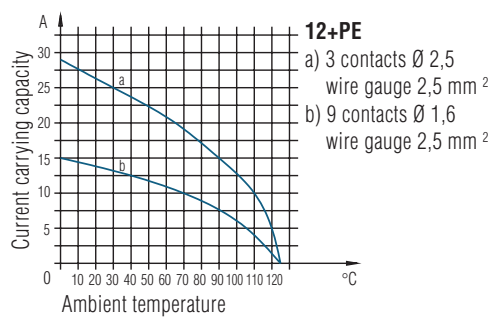
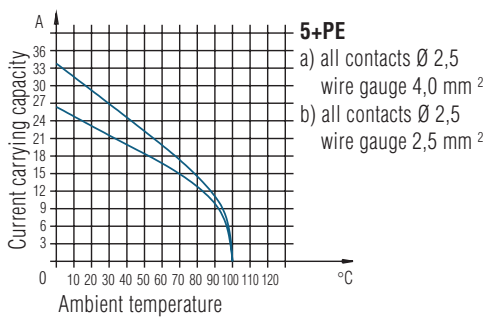

C 16-3Male cable connector,
Shell size 1 and 2

Identification	Figure	Description	Conn. Style	Page	
				Size 1	Size 2
Male cable connector		Long version with internal cable clamp	I	12	15
		Short version, with clamping ring	H	12	15
		Right -angled, with clamping ring	K	12	15
Female cable connector		Long version with internal cable clamp	E	13	16
		Short version, with clamping ring	D	13	16
		Right-angled, with clamping ring	F	13	16
Female receptacle		Flange mounting, with mounted gasket	G	13	15
		Panel mounting with ring nut, with gasket	N	13	–
Male receptacle		Flange mounting, with mounted gasket	C	14	16

C 16-3

Assembly instructions Shell size 1 and 2

Torque for back shell and cable screw
min. 1 Nm
max. 2 Nm

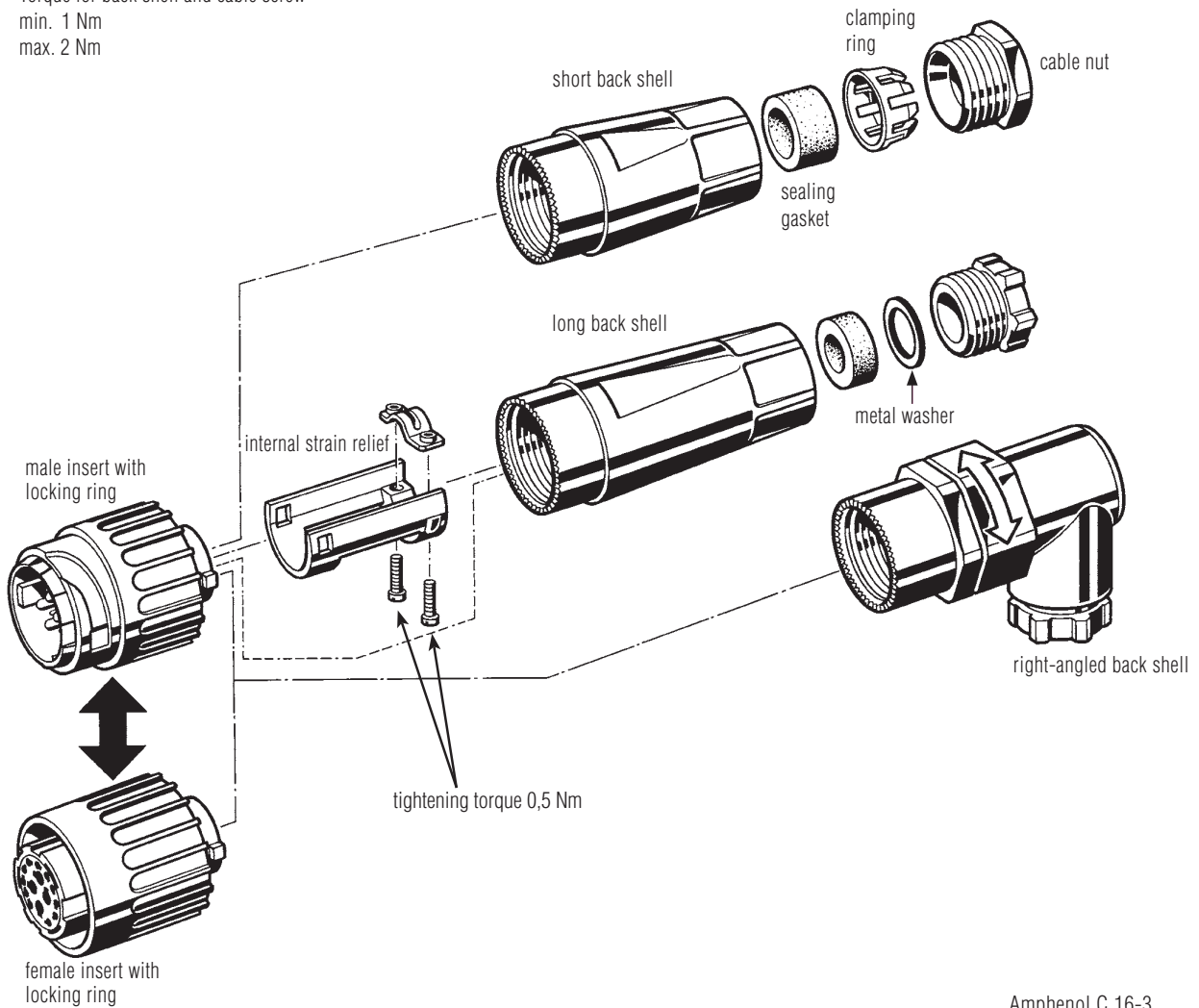

Amphenol C 16-3

Shinning lengths

Screw contacts		7,0+1 mm ¹⁾
Crimp contacts	0,14 - 0,50 mm ²	3+0,5 mm
	0,50 - 2,50 mm ²	3,5+1 mm

¹⁾ end splice recommended

C 16-3

Shell size 2 Female cable connectors



E



D



F

Description	Drawing	No. of cont.	Contacts ²⁾	Part No. Cable outlet ³⁾		
				Ø 12-14	Ø 14-16	Ø 19-21
Female cable connector, long, style E with internal strain relief, 5 + PE screw termination, 12 + PE-, 14 + PE and 19 + PE-version without contacts ¹⁾		5 + PE	-	C016 20E005 103 2	C016 20E005 104 2	C016 20E005 105 2
		12 + PE	9 x .N 02 016 00... 4 x .N 02 025 00...	C016 10E012 003 2	C016 10E012 004 2	C016 10E012 005 2
		14 + PE	4 x .N 02 015 00... 11 x .N 02 016 00...	C016 10E014 003 2	C016 10E014 004 2	C016 10E014 005 2
		19 + PE	.N 02 015 00...	C016 10E019 003 2	C016 10E019 004 2	C016 10E019 005 2
				Cable outlet		
				Ø 10-12	Ø 12-14	
Female cable connector, short, style D with clamping ring, 5 + PE screw termination, 12 + PE-, 14 + PE and 19 + PE-version without contacts ¹⁾		5 + PE	-	C016 20D005 103 2	C016 20D005 104 2	-
		12 + PE	9 x .N 02 016 00... 4 x .N 02 025 00...	C016 10D012 003 2	C016 10D012 004 2	-
		14 + PE	4 x .N 02 015 00... 11 x .N 02 016 00...	C016 10D014 003 2	C016 10D014 004 2	-
		19 + PE	.N 01 015 00...	C016 10D019 003 2	C016 10D019 004 2	-
Female cable connector, style F with clamping ring, 5 + PE screw termination, 12 + PE-, 14 + PE and 19 + PE-version without contacts ¹⁾		5 + PE	-	-	C016 20F005 104 2	-
		12 + PE	9 x .N 02 016 00... 4 x .N 02 025 00...	-	C016 10F012 004 2	-
		14 + PE	4 x .N 02 015 00... 11 x .N 02 016 00...	-	C016 10F014 004 2	-
		19 + PE	.N 02 015 00...	-	C016 10F019 004 2	-

C 16-3

Shell size 2 Male receptacle



C

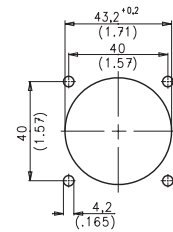

Panel cutout

Description	Drawing	No. of cont.	Contacts ²⁾	Part No.
Male receptacle, style C, 5 + PE screw termination, 12 + PE-, 14 + PE and 19 + PE-version without contacts ¹⁾		5 + PE	-	C016 20C005 100 2
		12 + PE	9 x .N 01 016 00... 4 x .N 01 015 00...	C016 10C012 000 2
		14 + PE	4 x .N 01 015 00... 11 x .N 01 016 00...	C016 10C014 000 2
		19 + PE	.N 01 015 00...	C016 10C019 000 2

¹⁾ Please order crimp contacts separately, see page 21/22. ²⁾ Part No system for crimp contacts, see page 23.