



Serie 440

Ü
TI

Miniatur Rundsteckverbinder Serie 440 Miniature circular connectors series 440

Kurzinformation Brief information

Kabelsteckverbinder

- Steckverbinder mit Push-Pull Verriegelung
- Schutzart IP 67¹⁾
- Schirmbare Kabelsteckverbinder mit sehr guten EMV Eigenschaften
- Kabeldurchlass 4 - 8 mm
- Druckschraube mit Vibrationsbremse

Cable Connector

- Connector with Push-Pull locking
- Degree of protection IP 67¹⁾
- Shielded cable connector with excellent EMC protection
- Cable outlet 4 - 8 mm (.16 - .24 inch)
- Pressing screw with immunity to vibration

Aufbau des Steckverbinders:
Construction of the connector:

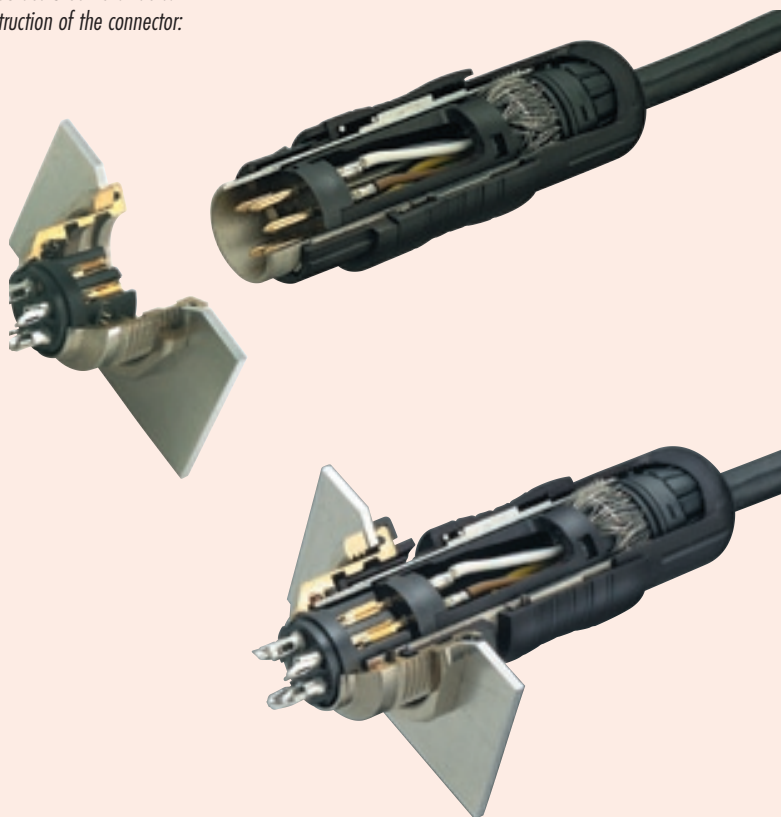

Flanschsteckverbinder

- Schirmbare und nicht schirmbare Versionen
- Ausführungen mit Schutzart IP 40 und IP 67
- Funktionstrennung von Schirmung und Dichtung
- Versenkter Einbau von Dosen und Steckern

Chassis sockets

- Shielded and not shielded versions
- Versions with degree of protection IP 40 and IP 67
- Separated function for shielding and sealing
- Immersed assembly for female and male sockets

Schirmbare Ausführung IP 67:
Shielded version IP 67:

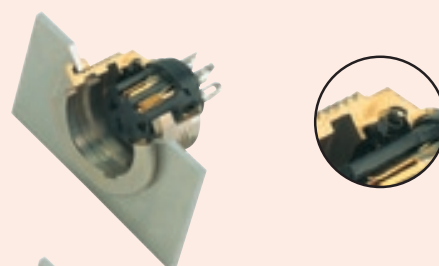

Nicht schirmbare Ausführung IP 67:
Not shielded version IP 67:

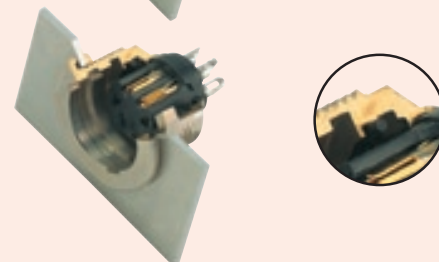

Nicht schirmbare Ausführung IP 40:
Not shielded version IP 40:

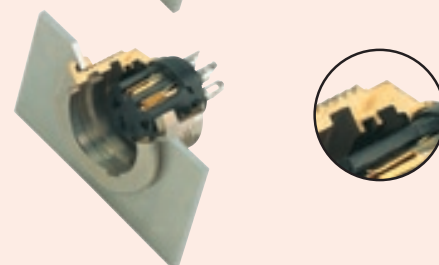

¹⁾ Erläuterung der Schutzarten siehe Seite TI-3 – TI-4. / ¹⁾ Explanation of protection standards see page TI-3 – TI-4.

620
702
709
710
711
712
719
423
425
440
581
678
680
682
720
723
623
690
691
692
693
694
707
713
718
733
763
765
768
714
715
766
815
820
825
876
772
775
A
B
C
R

Miniatur Rundsteckverbinder Serie 440 Miniature circular connectors series 440		Technische Daten ¹⁾ Specifications ¹⁾								
Allgemeine Kennwerte		General Characteristics								
Polzahl	Number of contacts	3 DIN	4	5	6 DIN	7	8 DIN	12	14	19
Verriegelung	Locking system	Push - Pull / Push - Pull								
Anschlussart	Termination	löten / solder								
Anschlussquerschnitt in mm ²	Wire gauge in mm ²	max. 0,75					max. 0,25			
Anschlussquerschnitt in AWG	Wire gauge in AWG	max. 20					max. 24			
Kabeldurchlass	Cable outlet	4 - 8 mm (.16 - .32)								
Schutzart Gehäuse	Shell protection	IP 67								
Mechanische Lebensdauer	Mechanical operation	> 1000 Steckzyklen / > 1000 mating cycles								
Obere Grenztemperatur	Upper temperature	+ 95 °C (+ 203 °F)								
Untere Grenztemperatur	Lower temperature	- 25 °C (- 13 °F)								
Gewicht Kabelsteckverbinder	Weight cable connector	~ 23 g								
Gewicht Flanschsteckverbinder	Weight socket	~ 23 g								
Elektrische Kennwerte		Electrical Characteristics								
Bemessungsspannung	Rated voltage	250 V (32 V)			125 V (32 V)			60 V (32 V)		
Bemessungs-Stoßspannung	Rated impulse voltage	1500 V			800 V			500 V		
Verschmutzungsgrad	Pollution degree	1 (2) ²⁾								
Überspannungskategorie	Overvoltage categorie	I (II) ²⁾								
Isolierstoffgruppe	Material group	III								
Prüfstoßspannung	Test voltage	1750 V			910 V			550 V		
Bemessungsstrom (40 °C)	Rated current (40 °C)	7 A	6 A	5 A			3 A			
Durchgangswiderstand	Contact resistance	≤ 3 mΩ								
Isolationswiderstand	Insulation resistance	≥ 10 ¹⁰ Ω								
Werkstoffe		Materials								
Kontaktstift	Pin contact	CuZn (Messing/brass)								
Kontaktbuchse	Socket contact	CuSn (Bronze/bronze)								
Kontaktoberfläche	Contact plating	Au (Gold/gold)								
Isolierkörper	Insert	PBT (UL 94 V-0)								
Gehäuse Kabelsteckverbinder	Housing cable connector	Gehäuse/housing: PA 66 GF 25 (UL 94 V-0), Hülse/sleeve: GD - ZnAl, vernickelt/nickel plated								
Gehäuse Flanschsteckverbinder	Housing socket	CuZn (Messing, vernickelt/brass, nickel plated)								



¹⁾ Normen und Prüfbedingungen für diese Angaben siehe Seite TI-16. / Standards and test parameters for this data see page TI-16.







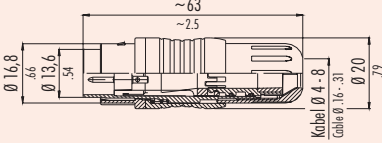

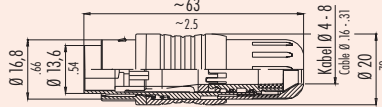
²⁾ Bei Verschmutzungsgrad 2, Überspannungskategorie II reduzierte Bemessungsspannung 32 V. / In case of pollution degree 2, overvoltage categorie II rated voltage is reduced to 32 V.

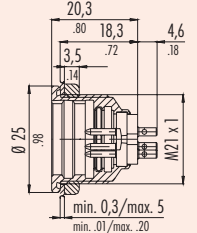
Ü
TI

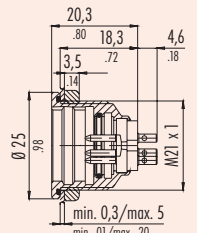
620
702
709
710
711
712
719
423
425
440
581
678
680
682
720
723
623
690
691
692
693
694
707
713
718
733
763
765
768
714
715
766
815
820
825
876
772
775
A
B
C

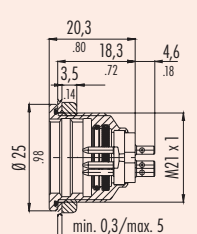
R

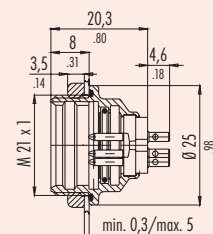

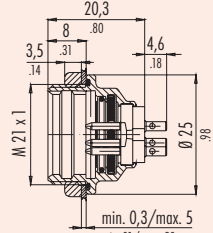



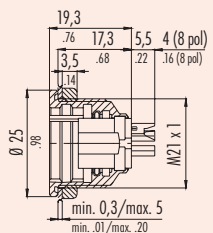

Miniatur Rundsteckverbinder Serie 440 Miniature circular connectors series 440		Steckverbinder Connectors	
Bezeichnung – Abbildung Description – Figure	Maßzeichnung Drawing	Polzahl Contacts	Bestell-Nr. Ordering-No.
Kabelstecker IP 67 Male cable connector IP 67 		3 DIN	99-4805-00-03
		4	99-4809-00-04
		5	99-4813-00-05
		6 DIN	99-4817-00-06
		7	99-4825-00-07
		8 DIN	99-4829-00-08
		12	99-4833-00-12
		14	99-4837-00-14
		19	99-4841-00-19
		Kabeldose IP 67 Female cable connector IP 67 	
4	99-4810-00-04		
5	99-4814-00-05		
6 DIN	99-4818-00-06		
7	99-4826-00-07		
8 DIN	99-4830-00-08		
12	99-4834-00-12		
14	99-4838-00-14		
19	99-4842-00-19		

Miniatur Rundsteckverbinder Serie 440 Miniature circular connectors series 440		Flanschstecker Male sockets	
Bezeichnung – Abbildung Description – Figure	Maßzeichnung Drawing	Polzahl Contacts	Bestell-Nr. Ordering-No.
Flanschstecker IP 40 <i>Male socket IP 40</i> 		3 DIN	09-4807-25-03
		4	09-4811-25-04
		5	09-4815-25-05
		6 DIN	09-4819-25-06
		7	09-4827-25-07
		8 DIN	09-4831-25-08
		12	09-4835-25-12
		14	09-4839-25-14
		19	09-4843-25-19
Flanschstecker IP 67 <i>Male socket IP 67</i> 		3 DIN	09-4807-15-03
		4	09-4811-15-04
		5	09-4815-15-05
		6 DIN	09-4819-15-06
		7	09-4827-15-07
		8 DIN	09-4831-15-08
		12	09-4835-15-12
		14	09-4839-15-14
		19	09-4843-15-19
Flanschstecker IP 67, geschirmt <i>Male socket IP 67, shielded</i> 		3 DIN	09-4807-00-03
		4	09-4811-00-04
		5	09-4815-00-05
		6 DIN	09-4819-00-06
		7	09-4827-00-07
		8 DIN	09-4831-00-08
		12	09-4835-00-12
		14	09-4839-00-14
		19	09-4843-00-19
Flanschstecker, von vorn verschraubbar, IP 67 <i>Male socket, front fastened, IP 67</i> 		3 DIN	09-4807-80-03
		4	09-4811-80-04
		5	09-4815-80-05
		6 DIN	09-4819-80-06
		7	09-4827-80-07
		8 DIN	09-4831-80-08
		12	09-4835-80-12
		14	09-4839-80-14
		19	09-4843-80-19
Flanschstecker, von vorn verschraubbar, IP 67, geschirmt <i>Male socket, front fastened, IP 67, shielded</i> 		3 DIN	09-4807-81-03
		4	09-4811-81-04
		5	09-4815-81-05
		6 DIN	09-4819-81-06
		7	09-4827-81-07
		8 DIN	09-4831-81-08
		12	09-4835-81-12
		14	09-4839-81-14
		19	09-4843-81-19

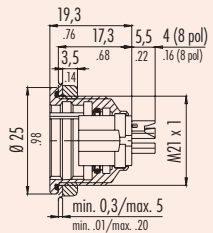
- 620
- 702
- 709
- 710
- 711
- 712
- 719
- 423
- 425
- 440
- 581
- 678
- 680
- 682
- 720
- 723
- 623
- 690
- 691
- 692
- 693
- 694
- 707
- 713
- 718
- 733
- 763
- 765
- 768
- 714
- 715
- 766
- 815
- 820
- 825
- 876
- 772
- 775
- A
- B
- C
- R

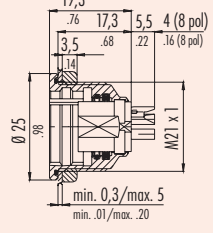
Polbilder siehe Seite 423-13 / Contact arrangements see page 423-13

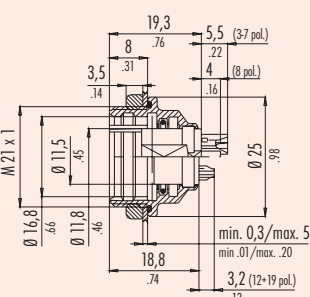
- Ü
- TI
- 620
- 702
- 709
- 710
- 711
- 712
- 719
- 423
- 425
- 440
- 581
- 678
- 680
- 682
- 720
- 723
- 623
- 690
- 691
- 692
- 693
- 694
- 707
- 713
- 718
- 733
- 763
- 765
- 768
- 714
- 715
- 766
- 815
- 820
- 825
- 876
- 772
- 775
- A
- B
- C
- R

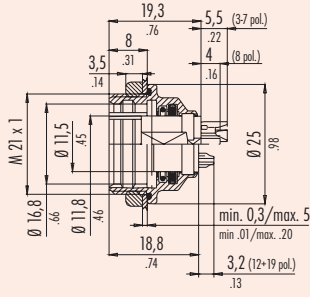
Miniatur Rundsteckverbinder Serie 440 Miniature circular connectors series 440		Flanschdosen Female sockets	
Bezeichnung – Abbildung Description – Figure	Maßzeichnung Drawing	Polzahl Contacts	Bestell-Nr. Ordering-No.
Flanschdose IP 40 <i>Female socket IP 40</i> 		3 DIN	09-4808-25-03
		4	09-4812-25-04
		5	09-4816-25-05
		6 DIN	09-4820-25-06
		7	09-4828-25-07
		8 DIN	09-4832-25-08
		12	09-4836-25-12
		14	09-4840-25-14
		19	09-4844-25-19
Flanschdose IP 67 <i>Female socket IP 67</i> 		3 DIN	09-4808-15-03
		4	09-4812-15-04
		5	09-4816-15-05
		6 DIN	09-4820-15-06
		7	09-4828-15-07
		8 DIN	09-4832-15-08
		12	09-4836-15-12
		14	09-4840-15-14
		19	09-4844-15-19
Flanschdose IP 67, geschirmt <i>Female socket IP 67, shielded</i> 		3 DIN	09-4808-00-03
		4	09-4812-00-04
		5	09-4816-00-05
		6 DIN	09-4820-00-06
		7	09-4828-00-07
		8 DIN	09-4832-00-08
		12	09-4836-00-12
		14	09-4840-00-14
		19	09-4844-00-19
Flanschdose, von vorn verschraubbar, IP 67 <i>Female socket, front fastened, IP 67</i> 		3 DIN	09-4808-80-03
		4	09-4812-80-04
		5	09-4816-80-05
		6 DIN	09-4820-80-06
		7	09-4828-80-07
		8 DIN	09-4832-80-08
		12	09-4836-80-12
		14	09-4840-80-14
		19	09-4844-80-19
Flanschdose, von vorn verschraubbar, IP 67, geschirmt <i>Female socket, front fastened, IP 67, shielded</i> 		3 DIN	09-4808-81-03
		4	09-4812-81-04
		5	09-4816-81-05
		6 DIN	09-4820-81-06
		7	09-4828-81-07
		8 DIN	09-4832-81-08
		12	09-4836-81-12
		14	09-4840-81-14
		19	09-4844-81-19

Polbilder siehe Seite 423-13 / Contact arrangements see page 423-13

Miniatur Rundsteckverbinder Serie 440 Miniature circular connectors series 440		Zubehör Accessories	
Bezeichnung Description	Abbildung Figure	Maßzeichnung Drawing	Bestell-Nr. Ordering-No.
Schutzkappe für Kabelsteckverbinder, IP 67 <i>Protection cap for cable connectors, IP 67</i>			08-2605-000-000
Schutzkappe für Flanschsteckverbinder, IP 67 <i>Protection cap for sockets, IP 67</i>			08-2604-000-001
Schutzkappe für Flanschsteckverbinder, IP 67 <i>Protection cap for sockets, IP 67</i>			08-2679-000-000
Schutzkappe für Flanschsteckverbinder, IP 40 <i>Protection cap for sockets, IP 40</i>			08-2603-000-001
Adapter für Kabel-Kabel Verbindung zur Aufnahme eines Flanschsteckverbinders <i>Adapter for a cable-cable connection to mate a socket connector</i>			08-2606-000-001

Ü
TI

620
702
709
710
711
712
719
423
425
440
581
678
680
682
720
723
623
690
691
692
693
694
707
713
718
733
763
765
768
714
715
766
815
820
825
876
772
775
A
B
C

R

Ü
TI

Miniatur Rundsteckverbinder Serie 440
Miniature circular connectors series 440

Einzelteildarstellung
Component part drawings

Kabelsteckverbinder
Cable connectors

620
702
709
710
711
712
719
440
581
678
680
682
720
723
623
690
691
692
693
694
707
713
718
733
763
765
768
714
715
766
815
820
825
876
772
775

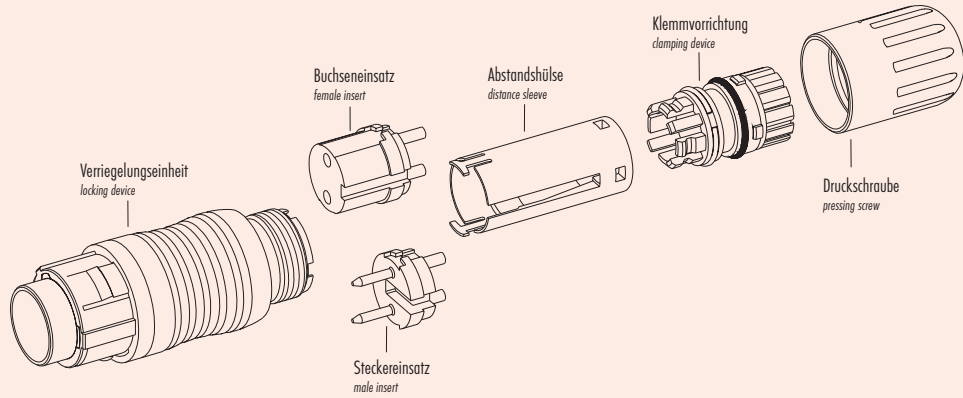

Flanschsteckverbinder
Socket connectors

690
691
692
693
694
707
713
718
733
763
765
768
714
715
766
815
820
825
876
772
775
A
B
C
R

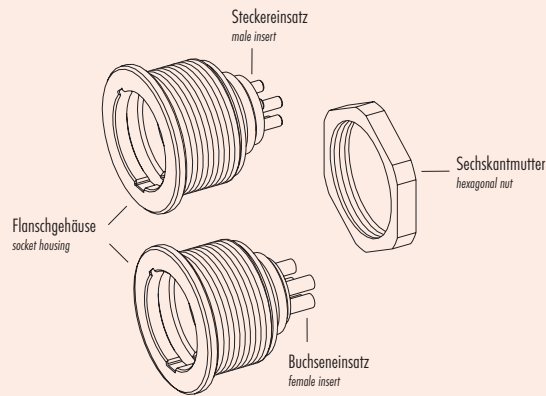

Montageausschnitt
Flanschsteckverbinder
Panel cut out
sockets

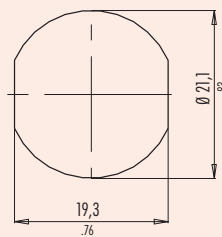

Miniatur Rundsteckverbinder Serie 440 Miniature circular connectors series 440

Montageanleitung Assembly instruction

1. Abmanteln auf L = 33 mm.
Ummantlung nicht abstreifen
 2. Druckschraube und Klemmvorrichtung auffädeln. Ummantlung entfernen
 3. Litzen abisolieren und verzinnen.
 4. Abschirmung auffächern und auskämmen. Die Abschirmlitzen in der Krone rundum einfädeln.
 5. Abstandshülse und Klemmvorrichtung verrasten.
 6. Gesteckte Einheit nach hinten übers Kabel schieben (ca. 10 mm).
 7. Einsätze anlöten.
 8. Gesteckte Einheit nach vorne schieben bis sie in den Kontakteinsatz einrastet.
 9. Abschirmlitzen in Richtung Abschirmring abstreifen und kürzen.
zu lang: Litzen auf Dichtring - undicht
zu kurz: kein Kontakt zu Wellenring
 10. Montierte Einheit in Trägerhülse stecken und Druckschraube festziehen.
-
1. *Unsheating to length: 33 mm (1.30 in.)
But do not strip cable jacket*
 2. *Thread pressing screw and clamp device.
Remove cable jacket.*
 3. *Strip the insulation of wires and tin.*
 4. *Fanning and comb out sheath of shielding. Thread wires around top.*
 5. *Lock distance sleeve and clamp device.*
 6. *Push mated units backwards over cable (appr. .39 inch).*
 7. *Solder inserts.*
 8. *Push mated units forward until snap-in to contact insert.*
 9. *Strip wires towards shield ring and shorten.*
if too long: wires on seal ring - not tight
if too short: no contact to wave ring
 10. *Mate assembled unit into carrier sleeve and tighten pressing screw.*

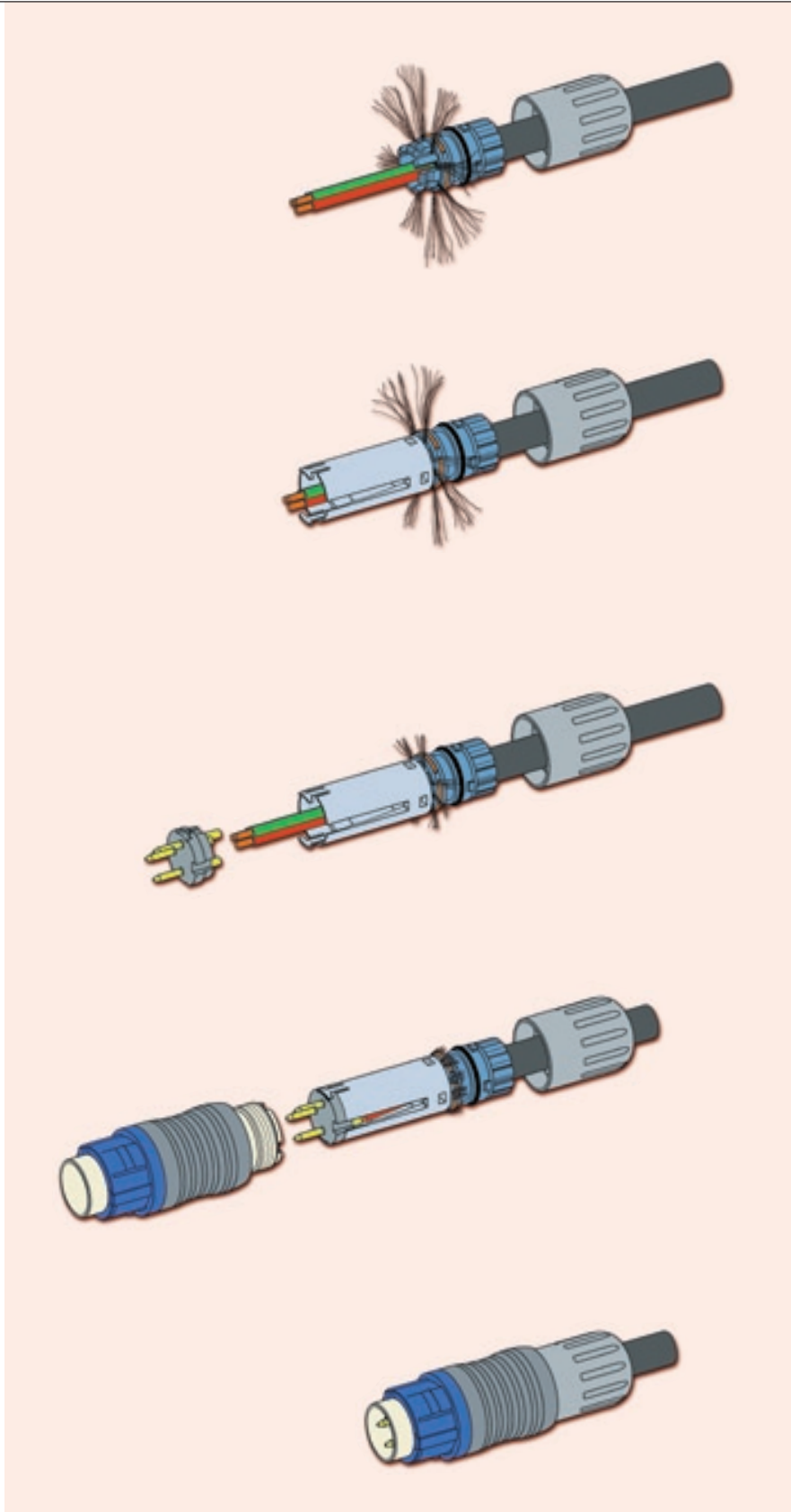

Ü
TI

620
702
709
710
711
712
719
423
425
440
581
678
680
682
720
723
623
690
691
692
693
694
707
713
718
733
763
765
768
714
715
766
815
820
825
876
772
775
A
B
C
R

Ü
TI

Miniatur Rundsteckverbinder Serie 440
Miniature circular connectors series 440

Funktionsdarstellung
Functional drawing

- 620
- 702
- 709
- 710
- 711
- 712
- 719
- 440
- 581
- 678
- 680
- 682
- 720
- 723
- 623
- 690
- 691
- 692
- 693
- 694
- 707
- 713
- 718
- 733
- 763
- 765
- 768
- 714
- 715
- 766
- 815
- 820
- 825
- 876
- 772
- 775
- A
- B
- C

- R

