

These are low installed cost connectors rated for up to 13 A and 250 V ac. They are typically used for circuit board and internal wiring applications. Snap Together connectors facilitate easy assembly and removal of equipment such as motors, fans, transformers, etc.

### Applications:

- Circuit board connections.
- Internal connections.

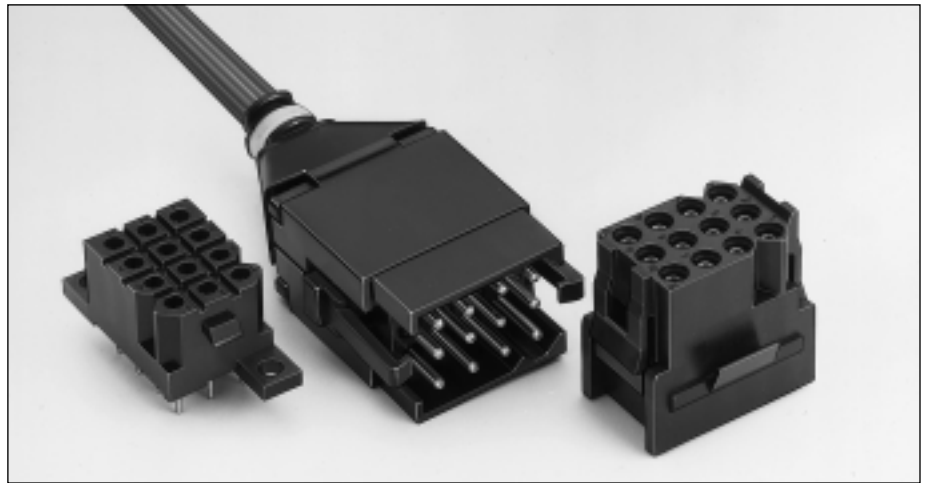

For more information: [www.ittcannon.com/cat001](http://www.ittcannon.com/cat001)

### Product Features

- Easy cost effective installation.
- Integrally molded latches and connector polarization.
- Recognized under the component program of UL Inc. and CSA.
- Inter-connector discrimination facilities available.
- Accepts formed (stamped) or machined contacts, see page 45.

### Performance Specifications

Operating Voltage	250 V ac rms
Contact Current Rating	Up to 13 A (For derating curve, see page 44)
Temperature Range	-55°C to 105°C (-67°F to 221°F) for Free Plug and Panel Receptacles -40°C to 105°C (-40°F to 221°F) for PCB Mounted Receptacles
Insulation Resistance	5000 MΩ at 500 V dc
Connector Latching Force	150 N min. with latches engaged
Test Voltage	2000 V ac for 60 secs
Panel Retention Force	500 N min.

### Materials and Finishes

Description	Material	Finish
Insulator	Black Nylon, UL 94V-0	None

## Contact Cavity Arrangements—Mating Face View

**2 Way**

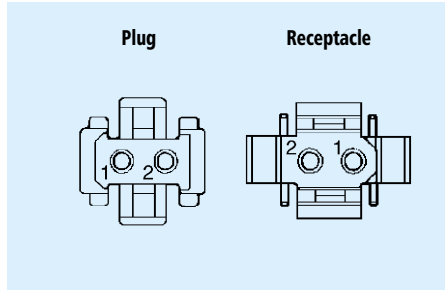

**3 Way**

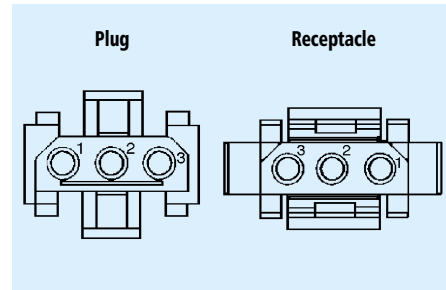

**4 Way**

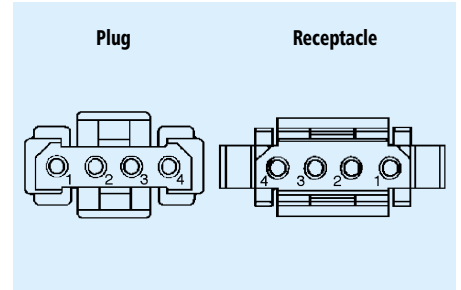

**6 Way**

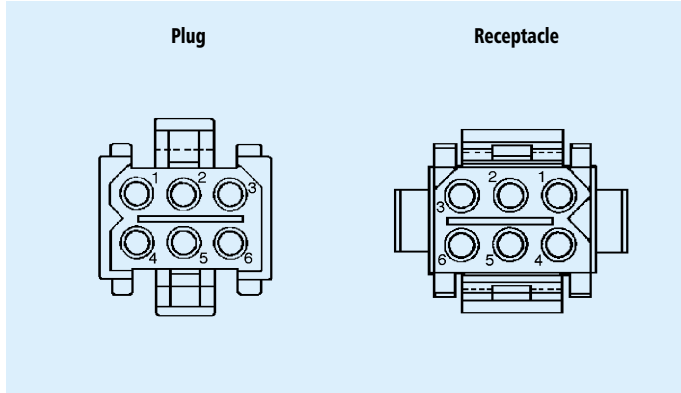

**12 Way**

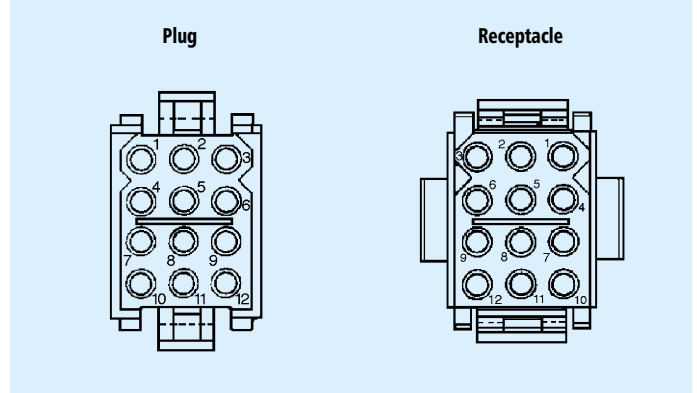

**24 Way**

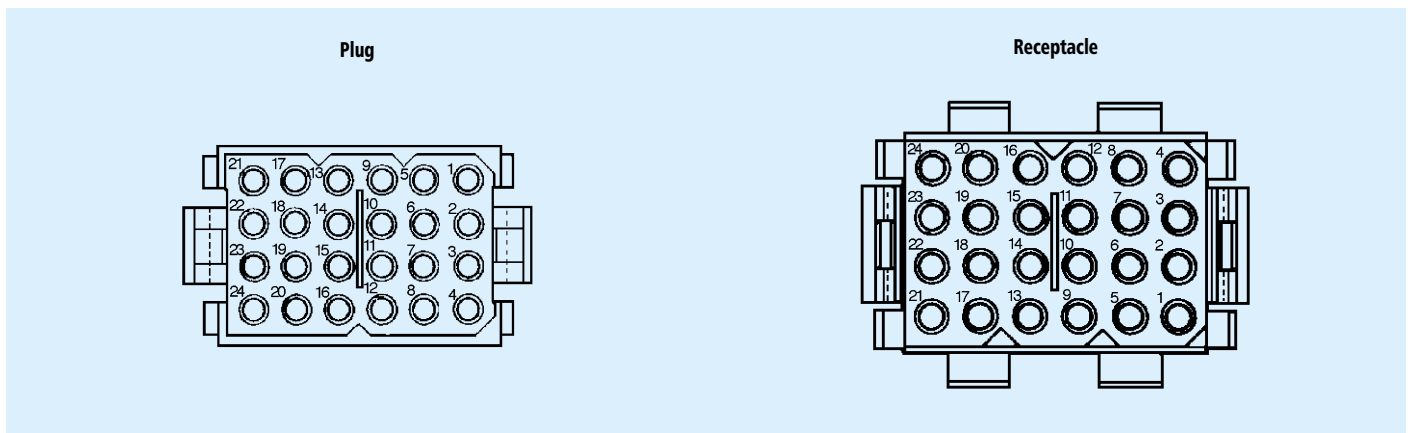

**36 Way**

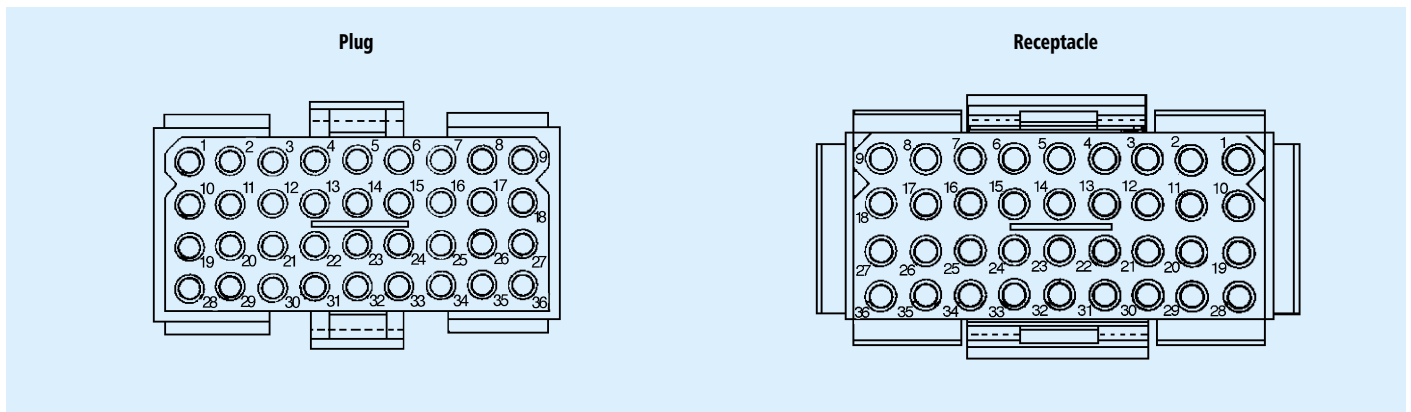

Snap Together  
Rectangular

## Free Plug

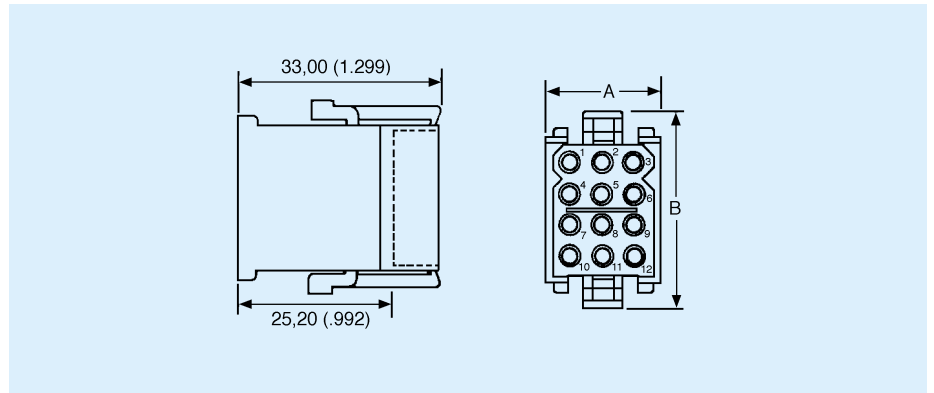

Snap Together Rectangular

- Accepts Pin or Socket contacts.
- Contacts to be ordered separately, see page 45.
- Mates with panel mounted receptacles, see page 7.
- Mates with PCB mounted receptacles, see pages 8-9.

Number of Contacts	Part Number (Pack of 100)	Nomenclature	Dimensions (max.)	
			A	B
2	192990-0350	TST 02 PA 00	15,50 (.610)	17,00 (.669)
3	192923-5920	TST 03 PA 00	19,00 (.748)	17,00 (.669)
4	192990-0370	TST 04 PA 00	24,00 (.944)	17,00 (.669)
6	192923-5930	TST 06 PA 00	19,00 (.748)	22,00 (.866)
12	192923-5940	TST 12 PA 00	19,00 (.748)	32,00 (1.259)
24	192923-5950	TST 24 PA 00	24,00 (.944)	42,00 (1.653)
36	192923-5960	TST 36 PA 00	49,50 (1.948)	32,00 (1.259)

## Plug Strain Relief Hood

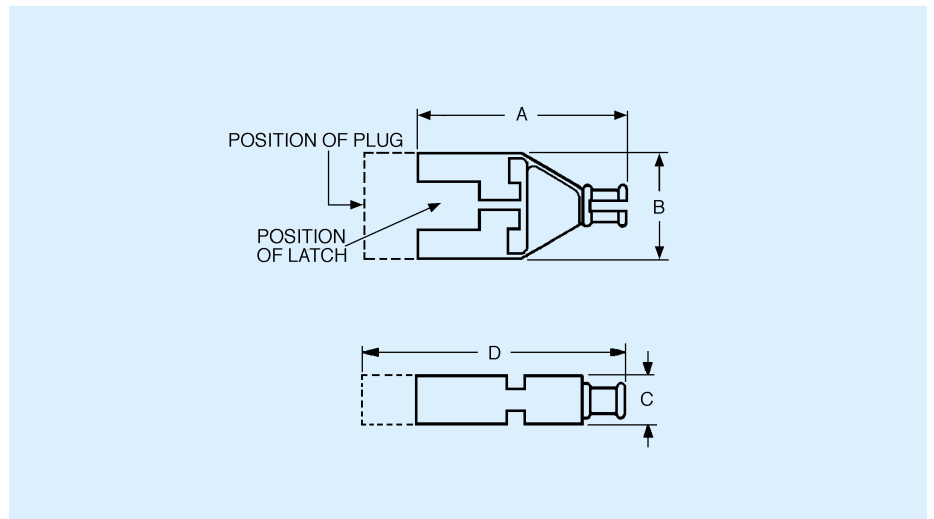
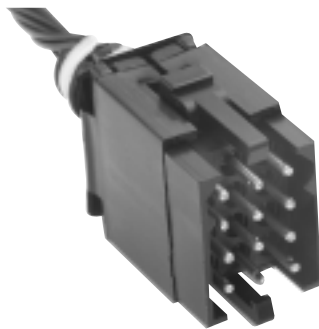

- Provides strain relief and wire protection.
- Secure with a tie-wrap (customer supplies tie-wrap).
- Connector Discriminating (Keying) Pins available, see page 50.

Number of Contacts	Part Number (Pack of 100)	Nomenclature	Wire Bundle Dia.	Dimensions (max.)			
				A	B	C	D
2	192990-0460	TST 02 AH 00	2,30-8,30 (.090-.326)	46,20 (1.818)	16,10 (.633)	11,00 (.433)	56,50 (2.224)
3	192990-0470	TST 03 AH 00	2,30-8,30 (.090-.326)	46,20 (1.818)	18,60 (.732)	11,00 (.433)	56,50 (2.224)
4	192990-0480	TST 04 AH 00	3,00-10,00 (.118-.393)	46,20 (1.818)	23,70 (.933)	11,00 (.433)	56,50 (2.224)
6	192923-5970	TST 06 AH 00	2,30-8,30 (.090-.326)	46,20 (1.818)	19,00 (.748)	16,40 (.645)	56,50 (2.224)
12	192923-5980	TST 12 AH 00	3,00-10,00 (.118-.393)	45,50 (1.791)	19,00 (.748)	26,40 (1.039)	55,80 (2.196)
24	192923-5990	TST 24 AH 00	4,60-12,70 (.181-.500)	51,00 (2.007)	24,10 (.948)	36,80 (1.448)	60,30 (2.374)
36	192923-6000	TST 36 AH 00	7,00-15,90 (.275-.625)	57,50 (2.263)	49,50 (1.948)	26,40 (1.039)	68,00 (2.677)

## Receptacle — Panel Mounted

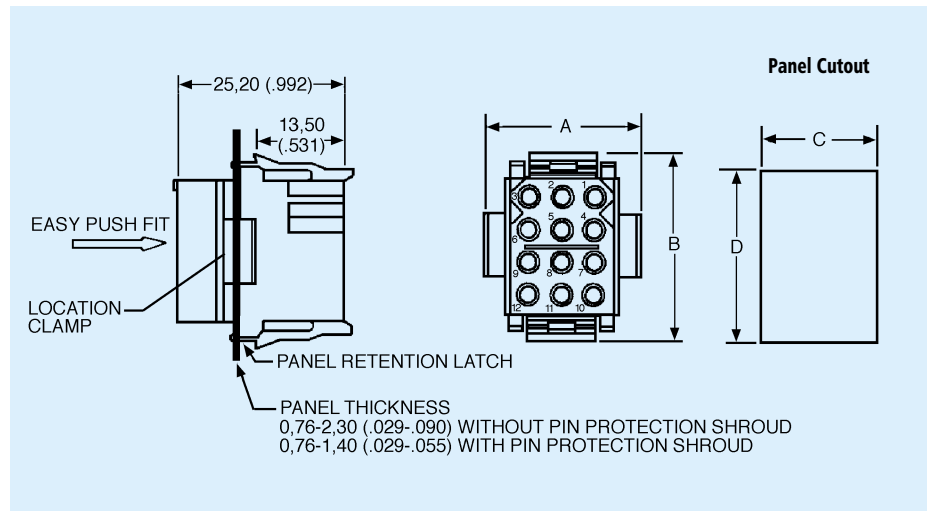

- Accepts Pin or Socket contacts.
- Contacts to be ordered separately, see page 45.
- Mates with Free Plugs, see page 6.

Number of Contacts	Part Number (Pack of 100)	Nomenclature	Dimensions			
			A	B	C ±0,13 (.005)	D ±0,13 (.005)
2	192990-0360	TST 02 RA00	19,00 (.748)	14,00 (.551)	11,50 (.452)	11,60 (.456)
3	192923-6010	TST 03 RA00	24,00 (.944)	14,00 (.551)	16,50 (.649)	11,60 (.456)
4	192990-0380	TST 04 RA00	29,00 (1.141)	13,50 (.531)	21,70 (.854)	11,60 (.456)
6	192923-6020	TST 06 RA00	24,00 (.944)	19,00 (.748)	16,50 (.649)	16,70 (.657)
12	192923-6030	TST 12 RA00	24,00 (.944)	29,00 (1.141)	16,70 (.657)	26,70 (1.051)
24	192923-6040	TST 24 RA00	29,00 (1.141)	39,00 (1.535)	21,80 (.858)	36,90 (1.452)
36	192923-6050	TST 36 RA00	54,20 (2.133)	29,00 (1.141)	46,70 (1.838)	26,40 (1.039)

## Protection Shrouds for Receptacles with Pin Contacts

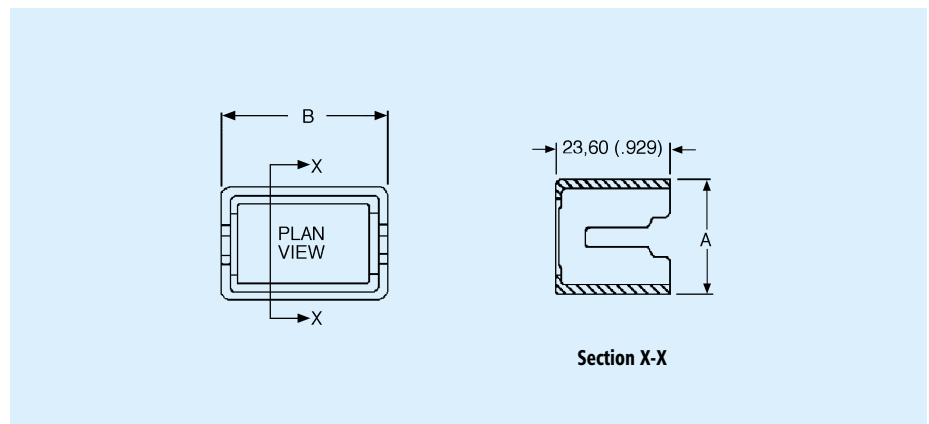

- Provides protection for panel mounted receptacles with pin contacts.
- Shrouds can be fitted onto panels up to 1,40 (.055) thick.
- Connector Discriminating (Keying) Pins available, see page 50.

Number of Contacts	Part Number (Pack of 100)	Nomenclature	Dimensions	
			A	B
3	192990-0400	TST 03 AS 00	23,50 (.925)	19,05 (.748)
4	192991-0668	TST 04 AS 00	28,60 (1.126)	19,05 (.748)
6	192990-0420	TST 06 AS 00	23,50 (.925)	24,13 (.948)
12	192990-0430	TST 12 AS 00	23,60 (.929)	34,20 (1.346)
24	192990-0440	TST 24 AS 00	29,70 (1.169)	44,40 (1.748)
36	192990-0450	TST 36 AS 00	54,40 (2.141)	34,00 (1.338)

## PCB Mounted Connectors — Pin Contacts

Snap Together Rectangular

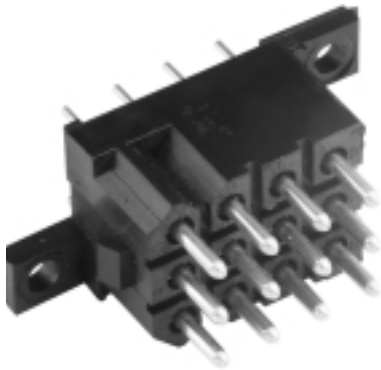

- Mates with Free Plug, see page 6.
- Integrally molded flanges.
- Contacts are on a 5,08 (.200) grid, symmetrical on center lines.
- Recommended PCB hole  $\varnothing 1,15$  (.045).
- Connector Discriminating Caps available, see page 50.

Figure 1

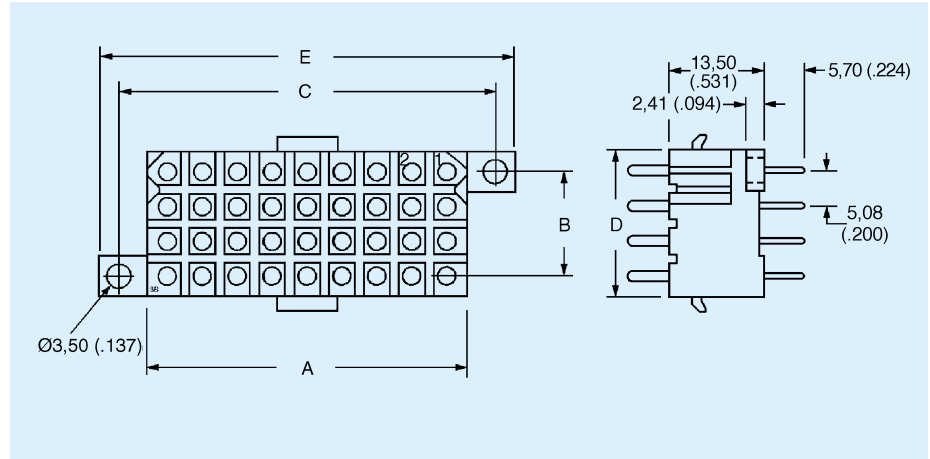
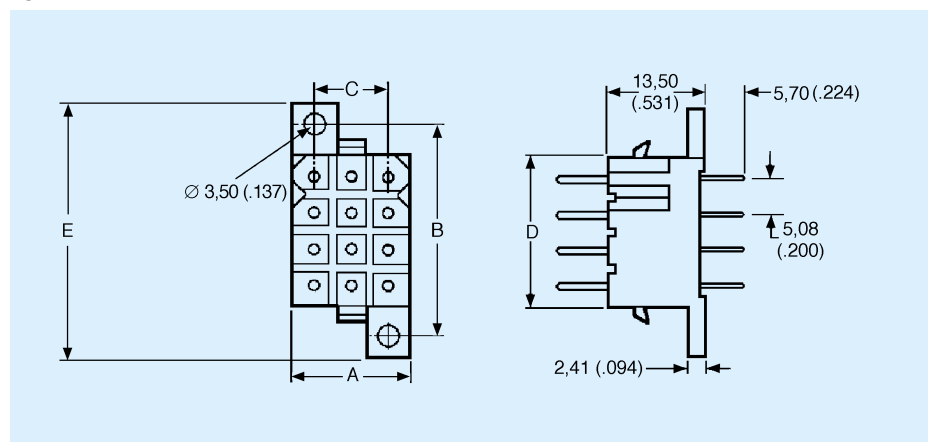

Figure 2



Number of Contacts	Plating	Formed (Stamped)		Machined			Dimensions				
		Part Number (Pack of 100)	Nomenclature	Part Number (Pack of 100)	Nomenclature	Figure	A	B $\pm 0,08$ (.003)	C $\pm 0,08$ (.003)	D	E
2	Gold*	192900-0411	TST 02 RB 05Y	192991-0270	TST 02 RB 01Z	1	11,13 (.438)	N/A	19,13 (.753)	6,00 (.236)	25,00 (.984)
2	Tin	192990-3230	TST 02 RB 05T	192991-0271	TST 02 RB 01T	1	11,13 (.438)	N/A	19,13 (.753)	6,00 (.236)	25,00 (.984)
3	Gold*	192900-0412	TST 03 RB 05Y	192991-0278	TST 03 RB 01Z	2	16,21 (.638)	14,05 (.553)	10,24 (.403)	6,00 (.236)	20,10 (.791)
3	Tin	192990-3240	TST 03 RB 05T	192991-0279	TST 03 RB 01T	2	16,21 (.638)	14,05 (.553)	10,24 (.403)	6,00 (.236)	20,10 (.791)
4	Gold*	192900-0413	TST 04 RB 05Y	192991-0286	TST 04 RB 01Z	2	21,30 (.838)	14,05 (.553)	15,32 (.603)	6,00 (.236)	20,10 (.791)
4	Tin	192990-3250	TST 04 RB 05T	192991-0287	TST 04 RB 01T	2	21,30 (.838)	14,05 (.553)	15,32 (.603)	6,00 (.236)	20,10 (.791)
6	Gold*	192900-0414	TST 06 RB 05Y	192991-0294	TST 06 RB 01Z	2	16,20 (.637)	19,12 (.752)	10,23 (.402)	11,00 (.433)	26,00 (1.023)
6	Tin	192990-3260	TST 06 RB 05T	192991-0295	TST 06 RB 01T	2	16,20 (.637)	19,12 (.752)	10,23 (.402)	11,00 (.433)	26,00 (1.023)
12	Gold*	192900-0415	TST 12 RB 05Y	192991-0302	TST 12 RB 01Z	2	16,20 (.637)	29,30 (1.153)	10,26 (.404)	21,20 (.834)	35,20 (1.385)
12	Tin	192990-3270	TST 12 RB 05T	192991-0303	TST 12 RB 01T	2	16,20 (.637)	29,30 (1.153)	10,26 (.404)	21,20 (.834)	35,20 (1.385)
24	Gold*	192900-0416	TST 24 RB 05Y	192991-0310	TST 24 RB 01Z	2	21,30 (.838)	39,37 (1.550)	15,32 (.603)	31,30 (1.232)	45,60 (1.795)
24	Tin	192990-3280	TST 24 RB 05T	192991-0311	TST 24 RB 01T	2	21,30 (.838)	39,37 (1.550)	15,32 (.603)	31,30 (1.232)	45,60 (1.795)
36	Gold*	192900-0417	TST 36 RB 05Y	192991-0402	TST 36 RB 01Z	1	46,60 (1.834)	15,24 (.600)	54,64 (2.151)	21,20 (.834)	60,50 (2.382)
36	Tin	192990-3290	TST 36 RB 05T	192991-0403	TST 36 RB 01T	1	46,60 (1.834)	15,24 (.600)	54,64 (2.151)	21,20 (.834)	60,50 (2.382)

\* Gold plating for Formed (Stamped) Contacts is 0,75  $\mu\text{m}$  (30  $\mu\text{in.}$ ) min gold. Gold plating for Machined Contacts is gold flash.

## PCB Mounted Connectors — Socket Contacts

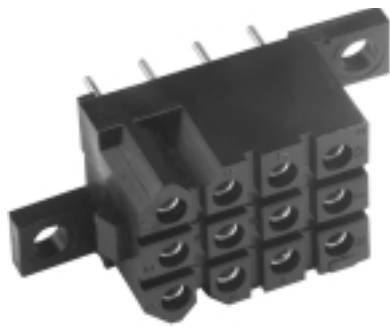

- Mates with Free Plug, see page 6.
- Integrally molded flanges.
- Contacts are on a 5,08 (.200) grid, symmetrical on center lines.
- Recommended PCB hole  $\varnothing$  1,15 (.045).
- Connector Discriminating Pins available, see page 50.

Figure 1

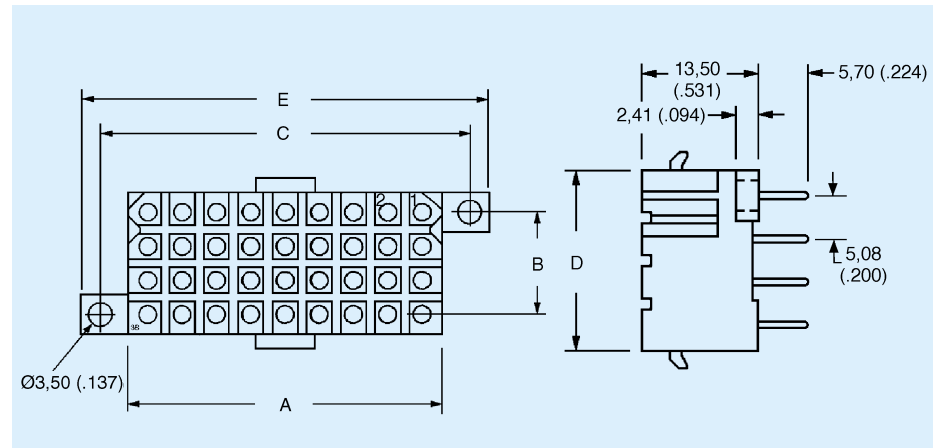
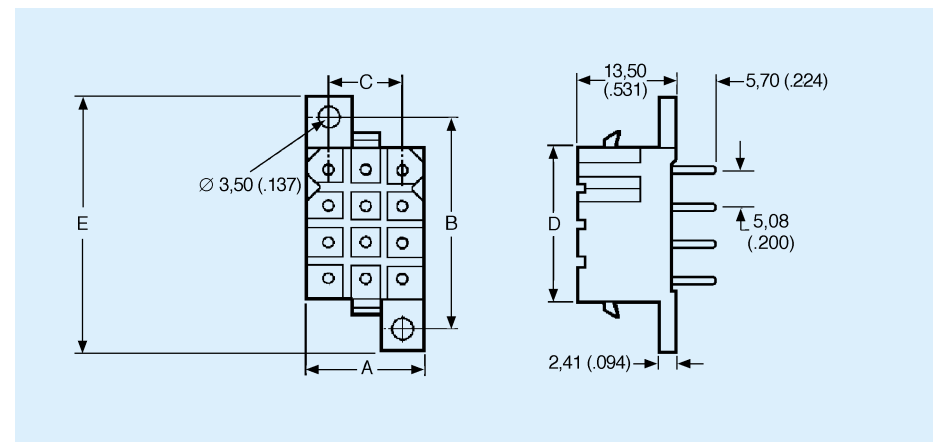

Figure 2



Number of Contacts	Plating	Formed (Stamped)		Machined			Dimensions				
		Part Number (Pack of 100)	Nomenclature	Part Number (Pack of 100)	Nomenclature	Figure	A	B $\pm 0,08 (.003)$	C $\pm 0,08 (.003)$	D	E
2	Gold*	192900-0418	TST 02 RB 06Y	192991-0213	TST 02 RB 02Z	1	11,13 (.438)	N/A	19,13 (.753)	6,00 (.236)	25,00 (.984)
2	Tin	192990-3300	TST 02 RB 06T	192991-0214	TST 02 RB 02T	1	11,13 (.438)	N/A	19,13 (.753)	6,00 (.236)	25,00 (.984)
3	Gold*	192900-0419	TST 03 RB 06Y	192991-0221	TST 03 RB 02Z	2	16,21 (.638)	14,05 (.553)	10,24 (.403)	6,00 (.236)	20,10 (.791)
3	Tin	192990-3310	TST 03 RB 06T	192991-0222	TST 03 RB 02T	2	16,21 (.638)	14,05 (.553)	10,24 (.403)	6,00 (.236)	20,10 (.791)
4	Gold*	192900-0420	TST 04 RB 06Y	192991-0229	TST 04 RB 02Z	2	21,30 (.838)	14,05 (.553)	15,32 (.603)	6,00 (.236)	20,10 (.791)
4	Tin	192990-3320	TST 04 RB 06T	192991-0230	TST 04 RB 02T	2	21,30 (.838)	14,05 (.553)	15,32 (.603)	6,00 (.236)	20,10 (.791)
6	Gold*	192900-0421	TST 06 RB 06Y	192991-0237	TST 06 RB 02Z	2	16,20 (.637)	19,12 (.752)	10,23 (.402)	11,00 (.433)	26,00 (1.023)
6	Tin	192990-3330	TST 06 RB 06T	192991-0238	TST 06 RB 02T	2	16,20 (.637)	19,12 (.752)	10,23 (.402)	11,00 (.433)	26,00 (1.023)
12	Gold*	192900-0422	TST 12 RB 06Y	192991-0245	TST 12 RB 02Z	2	16,20 (.637)	29,30 (1.153)	10,26 (.404)	21,20 (.834)	35,20 (1.385)
12	Tin	192990-3340	TST 12 RB 06T	192991-0246	TST 12 RB 02T	2	16,20 (.637)	29,30 (1.153)	10,26 (.404)	21,20 (.834)	35,20 (1.385)
24	Gold*	192900-0423	TST 24 RB 06Y	192991-0253	TST 24 RB 02Z	2	21,30 (.838)	39,37 (1.550)	15,32 (.603)	31,30 (1.232)	45,60 (1.795)
24	Tin	192990-3350	TST 24 RB 06T	192991-0254	TST 24 RB 02T	2	21,30 (.838)	39,37 (1.550)	15,32 (.603)	31,30 (1.232)	45,60 (1.795)
36	Gold*	192900-0424	TST 36 RB 06Y	192991-0261	TST 36 RB 02Z	1	46,60 (1.834)	15,24 (.600)	54,64 (2.151)	21,20 (.834)	60,50 (2.382)
36	Tin	192990-3360	TST 36 RB 06T	192991-0262	TST 36 RB 02T	1	46,60 (1.834)	15,24 (.600)	54,64 (2.151)	21,20 (.834)	60,50 (2.382)

\* Gold plating for Formed (Stamped) Contacts is 0,75  $\mu$ m (30  $\mu$  in.) min gold. Gold plating for Machined Contacts is gold flash.