



# Terminal Strips 16 mm<sup>2</sup>/AWG 6 without Jumper Slot, Pin Spacings 10 mm/0.394 in and 15 mm/0.591 in; Series 2716



**Pin spacing 10 mm / 0.394 in**  
**1.5 – 16 mm<sup>2</sup>** | **AWG 16 – 6**  
 250 V/4 kV/3; 76 A | 300 V, 55 A  $\mathcal{V}$   
 500 V/4 kV/2; 76 A  
 12 – 13 mm / 0.49 in

**Pin spacing 15 mm / 0.591 in**  
**1.5 – 16 mm<sup>2</sup>** | **AWG 16 – 6**  
 630 V/8 kV/3; 76 A | 600 V, 65 A  $\mathcal{V}$   
 1000 V/8 kV/2; 76 A  
 12 – 13 mm / 0.49 in

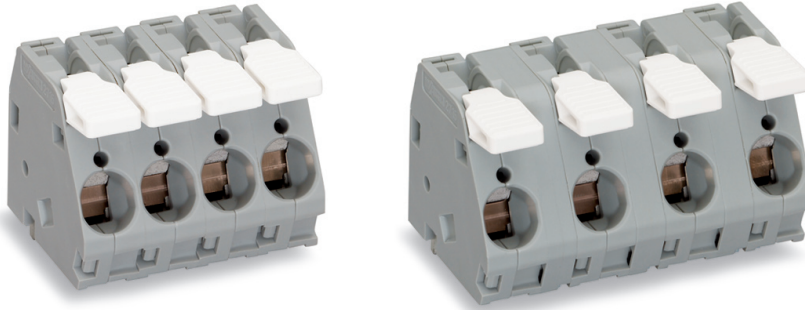



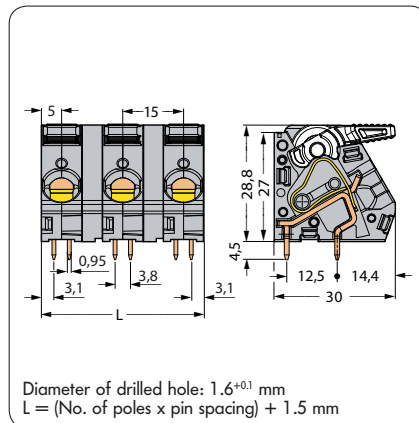
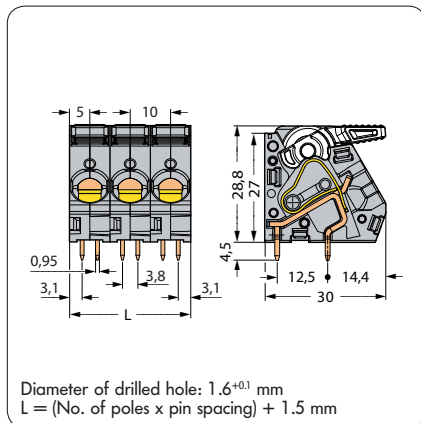

No. of poles	Item no.	Pack.-unit pcs			
<b>Terminal strips, gray,</b> with actuating lever, without jumper slot			<b>Terminal strips, gray,</b> with actuating lever, without jumper slot		
2	2716-102		2	2716-202	
3	2716-103		3	2716-203	
4	2716-104		4	2716-204	
5	2716-105		5	2716-205	
6	2716-106		6	2716-206	
7	2716-107		7	2716-207	
8	2716-108		8	2716-208	
Other numbers of poles and pin spacings on request			For other lengths, please contact factory		
Additional item nos. for colored terminal blocks:			Additional item nos. for colored terminal blocks:		
blue	... /000-006		blue	... /000-006	
light gray	... /000-009		light gray	... /000-009	
green-yellow	... /000-016		green-yellow	... /000-016	
light green	... /000-017		light green	... /000-017	

## Dimensions (in mm)









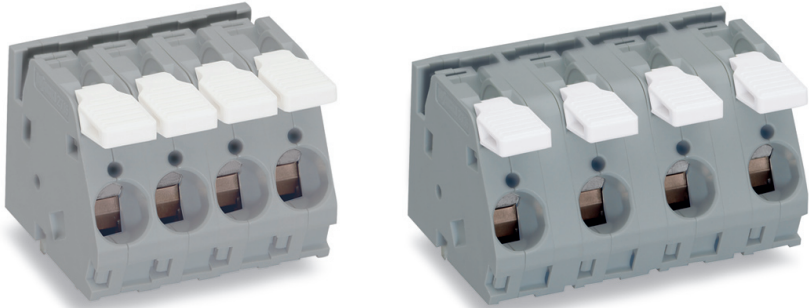











# Terminal Strips 16 mm<sup>2</sup>/AWG 6 with Jumper Slot, Pin Spacings 10 mm/0.394 in and 15 mm/0.591 in; Series 2716

CAGE CLAMP®

<b>Pin spacing 10 mm / 0.394 in</b> <b>1.5 – 16 mm<sup>2</sup></b> 250 V/4 kV/3; 76 A   <b>AWG 16 – 6</b> 300 V, 55 A  500 V/4 kV/2; 76 A  12 – 13 mm / 0.49 in	<b>Pin spacing 15 mm / 0.591 in</b> <b>1.5 – 16 mm<sup>2</sup></b> 630 V/8 kV/3; 76 A   <b>AWG 16 – 6</b> 600 V, 65 A  1000 V/8 kV/2; 76 A  12 – 13 mm / 0.49 in
--	---



No. of poles	Item no.	Pack.-unit			
<b>Terminal strips, gray, with actuating lever, with jumper slot</b>			<b>Terminal strips, gray, with actuating lever, with jumper slot</b>		
2	<b>2716-152</b>		2	<b>2716-252</b>	
3	<b>2716-153</b>		3	<b>2716-253</b>	
4	<b>2716-154</b>		4	<b>2716-254</b>	
5	<b>2716-155</b>		5	<b>2716-255</b>	
6	<b>2716-156</b>		6	<b>2716-256</b>	
7	<b>2716-157</b>		7	<b>2716-257</b>	
8	<b>2716-158</b>		8	<b>2716-258</b>	
Other numbers of poles and pin spacings on request			For other lengths, please contact factory		
Additional item nos. for colored terminal blocks:			Additional item nos. for colored terminal blocks:		
blue	... /000-006 		blue	... /000-006 	
light gray	... /000-009 		light gray	... /000-009 	
green-yellow	... /000-016 		green-yellow	... /000-016 	
light green	... /000-017 		light green	... /000-017 	
 <b>Comb type jumper bar</b> 1 to 3 <b>745-682</b> 200 (4x50)			 <b>Comb type jumper bar</b> 1 to 3 <b>745-631</b> 200 (4x50)		
 <b>2-way 745-582</b> 200 (4x50)			 <b>2-way 745-632</b> 200 (4x50)		
 <b>3-way 745-583</b> 200 (4x50)			 <b>3-way 745-633</b> 200 (4x50)		
 <b>4-way 745-584</b> 200 (4x50)			 <b>4-way 745-634</b> 200 (4x50)		
 <b>5-way 745-585</b> 200 (4x50)			 <b>5-way 745-635</b> 200 (4x50)		
<b>Dimensions (in mm)</b>					

