

62 GB- Series Accessories

CE-2Aa

Miniature Bayonet Lock Connectors
Complies with MIL-C-26482



This miniature bayonet lock connector series offers designers important features not found in any other range of connectors.

They are developed and manufactured entirely in the U.K. by AMPHENOL Ltd., and have full qualification approval to British Standards Specification BS 9522 F0017 and British Defence Specification DEF STAN 59-35 (Part 3) Sec. 7.

This catalogue to be used in conjunction with Catalogues:
CE-2Pa – 62GB Series Plugs
CE-2Ra – 62GB Series Receptacles

Amphenol

CONTENTS

Page

Amphenol 62GB Solder Connectors	3
Schedule of Tests	4-5
Accessories - Table of Styles	6-7
Accessories	8-14
Cable Accessories - Table of Styles	15-16
Cable Accessories	17-21

This catalogue to be used in conjunction with Catalogues:
CE-2Pa – 62GB Series Plugs
CE-2Ra – 62GB Series Receptacles

This miniature bayonet lock connector series offers designers important features not found in any other range of connectors. The range has full qualification approval to British Standards Specification BS 9522 FOO 17 and British Defence Specification DEF STAN 59-35 (Part 3) Sec. 7.

62GB Series connectors - developed and manufactured entirely in the United Kingdom by Amphenol Limited. They are the first and only British connectors to have achieved this. A doubly strong position which Amphenol are well geared to handle. The manufacturing facilities of the Whitstable plant have been cited as exemplary in Europe. Certainly the layout is extensive and extremely efficient; safety awards have been attained every time returns have been submitted to the British Safety Council.

62GB Series connectors have been well established with Government authorities on an international scale and users can be found in Sweden, Denmark, Norway, Finland, Germany, Spain, Holland, India, Canada and Italy.

Derating

Connectors must be derated under the following operating conditions:

1. At elevated ambient temperatures, the current ratings are reduced so that total maximum hot spot temperature of 125°C is not exceeded.
2. At high altitudes, revised voltage ratings become effective as shown on page 7.
3. When connectors to different specifications are intermated (e.g. BS 9522 FOO 17 and MIL-C26482), the combination must not be operated under conditions more severe than the less stringent clause of either specification.

Amphenol 62GB connectors are designed to meet the most stringent requirements of both specifications.

Military Specifications

British Standards Specification BS 9522 FOO 17 closely corresponds to the United States Military Specification MIL-C-26482 solder terminations. Certain differences exist between the schedules which can be seen on pages 2 and 3.

Approved gauges are used to check interchangeability of 62GB series with other connectors manufactured to BS 9522 FOO 17 or MIL-C-26482.

Amphenol® 62GB solder connectors

Basic Construction

62GB Series can be supplied in brass or stainless steel.

The normal shell finish used, which has a high resistance to corrosion, is zinc cobalt olive drab. Other finishes may be supplied to special order, such as cadmium plate which is available by adding deviation (714) to the end of part number.

Inserts are of polychloroprene rubber compounded to an Amphenol specification. Operating temperature range is -55°C to 125°C, and the connectors have gold-plated contacts designed for soldered connections. Configurations for size 20 contacts range between 2 contacts in the size 8 12.7mm (0.5in diameter) shell up to a maximum of 61 contacts in the size 2436.1 mm (1.5in diameter) shell. Intermediate sizes, and contact data for heavier current ratings are shown in the insert availability chart on page 6 and 7.

Hermetic connectors with glass sealed dielectric are manufactured with mild steel shells and nickel iron contacts plated tin over copper.

* Other finishes are available on request.

Protection Against Mis-Mating or Cross-Plugging

In BS 9522 FOO 17 positive shell-to-shell keying is provided with keys and keyways in a choice of either the normal (N) or any of the four preferred alternate positions: B, C, E and F. This prevents mismating between shells of different orientations and overcomes the difficulties associated with rotated inserts and a standard key-keyway orientation. In the latter system, damage to the inserts or contacts can result if excessive force is used to engage non-mating pairs.

Rotated inserts are, however, permissible in BS 9522 FOO 17 connectors if required to mate with or replace units to MIL-C-26482 mounted in existing equipment. Connectors have normal orientations manufactured to BS 9522 FOO 17 or MIL-C-26482 are fully intermateable as also are connectors with inserts in positions W, X, Y or Z.

Schedule of Tests Required for Qualification Approval









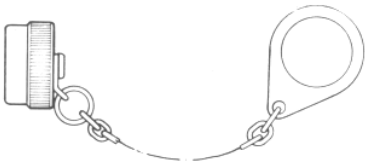

Tests	Brief Description
Visual Examination	
Dimensions, outline mass(including contacts) Compatability Gauging procedure	
Polarization	
Engaging and separating force, connector	Engagement max: 0,90 Nm (8.0 lbf.in.) to 4,97 Nm (44 lbf.in.) according to shell size. Separation min: 0,22 Nm (2.0 lbf.in.) to 1,58 Nm (14.0 lbf.in.) according to shell size.
Contact Holding Force	0,21 N (0.047 lbf) min.size 20 0,56 N (0.126 lbf)min. size 16
Sealing (air pressure)	Max leakage 28,53 uNm/s (1 cm3/h), 1 bar (14.5 p.s.i.) differential.
Sealing Hermetic	Hermetic receptacles have a max leak of 0.1 micron cubic foot per hour (1 x 10 ⁻⁶ Cm3/s)
Contact Resistance	5 milliohms max.
Housing (Shell) Continuity	200 milliohms max. 5 milliohms max. grounding spring styles.
Insulation Resistance	5,000 Megaohms at 500 - 50 V d.c.
Voltage Proof	See page 7. Duration 1 minute
Soldering	As BS 9520: 1974, Clause 1.2.6.6, Method 2.
Bumping	As BS 9520: 1974, Clause 1.2.6.1. 4,000 -10 bumps / 390m / s ² (40 gn).
Vibration	As BS 9520: 1974, Clause 1.2.6.2.1. Procedure A. 10 Hz to 5000 Hz, 0.75 mm / 10 gn.
Shock	As BS 9520: 1974, Clause 1.2.6.3. 981 m/s ² (100 g n).
Acceleration (Steady State)	As BS 9520: 1974, Clause 1.2.6.4. 490 m/s ² (50 gn).
Rapid Change of Temperature	As BS 9520: 1974, Clause 1.2.6.7. -550 C to - 1250 C.
Climatic Sequence	As BS 9520: 1974, Clause 1.2.6.11. Severity 55/125/56.
Flammability	As BS 9520: 1974, Clause 1.2.6.8. Direct flame applied, duration 1 minute.
Damp Heat (Steady State)	As BS 9520: 1974, Clause 1.2.6.14. Severity 56 days.

Schedules of Tests Required for Qualification Approval

Tests	Brief Description
Immersion (at low air pressure)	3 cycles at 30 mins each cycle, total immersion in water at pressure 44 m bar.
Mechanical Endurance	500 operations minimum
High Temperature Endurance	Long term: 1,000 hrs. at 85°C ambient carrying the specified current. Short term: 250 hrs at 125°C, no current.
Mould Growth	As BS 9520: 1983, Clause 1.2.6.16. 28 days duration.
Salt Mist	As BS 9520: 1983, Clause 1.2.6.17. Severity 1.
Dust	As BS 9520: 1983, Clause 1.2.6.18 Exposure 30 minutes.
Robustness of Terminations	44,5 N (101bf) size 16 22,2 N (5 lbf) size 20
Contact Retention (in insert)	67,0 N (15 lbf) min. size 20 112,0 N (25 lbf) min. size 16
Insert Retention (in shell)	517 KN1m2 (751bf/in2) min.
Test Prod Damage	Moment: 0,056 Nm (0.5 lbf in) size 20 0,225 Nm (2 lbf in) size 16
Impact	Five impacts, drop height 1 m (3ft.3 in.).
Grounding Spring Holding Force Plugs with grounding springs only.	1,17 N (0.263 lbf) to 2,74 N (0.616 lbf) according to size.
Fluid Resistance	Immersion in 4 solvents and 9 fluids including aircraft fuels, lubricating oils and hydraulic fluids.
Compass Safe Distance	As BS 9520: 1974, Clause 1.2.5.11. 127 mm (5.0 in) min.

Accessories

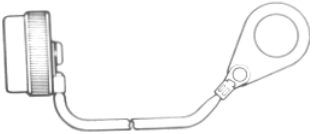







Table of Styles

			Page No.
62GB-736			42
62GB-737			42
62GB-738			43
62GB-742			43
62GB-810			44
62GB-812			44
62GB-813			45

Accessories

Table of Styles

Page No.

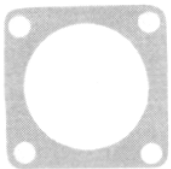
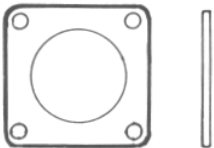
62GB-814			45
62GB-997			46
62GB-998			46
62GB-1069			47
62GB-1070			47
62GB-760			48

Accessories



62GB-736

Caps and chains for single hole mounting receptacles

Shell Size	A ± 0.25 (± 6.35)	B ± 0.005 (± 0.13)	C dia max	J ± 0.005 (± 0.127)
08	3.0	0.521	0.734	0.578
	76.2	13.23	18.64	14.68
10	3.0	0.521	0.859	0.703
	76.2	13.23	21.82	17.86
12	3.5	0.521	1.000	0.891
	88.9	13.23	25.4	22.63
14	3.5	0.521	1.125	1.016
	88.9	13.23	28.57	25.81
16	3.5	0.521	1.250	1.141
	88.9	13.23	31.75	29.39
18	3.5	0.521	1.375	1.266
	88.9	13.23	34.92	32.16
20	4.0	0.521	1.500	1.391
	101.6	13.23	38.1	35.33
22	4.0	0.521	1.625	1.516
	101.6	13.23	41.27	38.51
24	4.0	0.556	1.750	1.641
	101.6	14.12	44.45	41.68

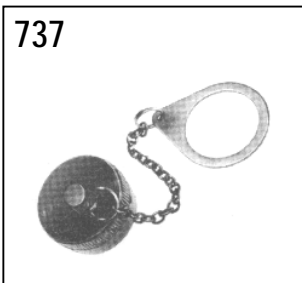

62GB-737

Caps and chains for cable mounting receptacles.

Shell Size	A ± 0.25 (± 6.35)	B ± 0.005 (± 0.13)	C dia max	J ± 0.005 (± 0.127)
08	3.0	0.521	0.734	0.458
	76.2	13.23	18.64	11.63
10	3.0	0.521	0.859	0.583
	76.2	13.23	21.82	14.81
12	3.5	0.521	1.000	0.708
	88.9	13.23	25.4	17.98
14	3.5	0.521	1.125	0.896
	88.9	13.23	28.57	22.76
16	3.5	0.521	1.250	1.021
	88.9	13.23	31.75	25.93
18	3.5	0.521	1.375	1.146
	88.9	13.23	34.92	29.11
20	4.0	0.521	1.500	1.271
	101.6	13.23	38.1	32.28
22	4.0	0.521	1.625	1.396
	101.6	13.23	41.27	35.46
24	4.0	0.556	1.750	1.521
	101.6	14.12	44.45	38.63

Accessories



62GB-738

Caps and chains for flange mounting receptacles.

Shell Size	A ± 0.25 (± 6.35)	B ± 0.005 (± 0.13)	C dia max	J ± 0.005 (± 0.127)
08	3.0	0.521	0.734	0.125
	76.2	13.23	18.64	3.18
10	3.0	0.521	0.859	0.125
	76.2	13.23	21.82	3.18
12	3.5	0.521	1.000	0.125
	88.9	13.23	25.4	3.18
14	3.5	0.521	1.125	0.125
	88.9	13.23	28.57	3.18
16	3.5	0.521	1.250	0.125
	88.9	13.23	31.75	3.18
18	3.5	0.521	1.375	0.125
	88.9	13.23	34.92	3.18
20	4.0	0.521	1.500	0.125
	101.6	13.23	38.1	3.18
22	4.0	0.521	1.625	0.125
	101.6	13.23	41.27	3.18
24	4.0	0.556	1.750	0.152
	101.6	14.12	44.45	3.86



62GB-742

Caps and chains for plugs.

Shell Size	A ± 0.25 (± 6.35)	B ± 0.005 (± 0.13)	C dia max	J ± 0.005 (± 0.127)
08	3.0	0.522	0.719	0.125
	76.2	13.25	18.26	3.18
10	3.0	0.522	0.844	0.125
	76.2	13.25	21.43	3.18
12	3.5	0.522	1.000	0.125
	88.9	13.25	25.4	3.18
14	3.5	0.522	1.125	0.125
	88.9	13.25	28.57	3.18
16	3.5	0.522	1.250	0.125
	88.9	13.25	31.75	3.18
18	3.5	0.522	1.357	0.125
	88.9	13.25	34.92	3.18
20	4.0	0.584	1.500	0.125
	101.6	14.83	38.1	3.18
22	4.0	0.584	1.625	0.125
	101.6	14.83	41.27	3.18
24	4.0	0.617	1.750	0.152
	101.6	15.67	44.45	3.86

Accessories

810



62GB-810
BS9522-F0017-A2012

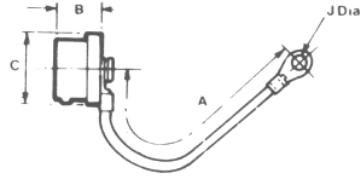

Caps and cords for plugs

Shell Size	A ± 0.25 (± 6.35)	B ± 0.005 (± 0.13)	C dia max	J ± 0.003 (± 0.08)
08	3.0 76.2	0.522 13.25	0.719 18.26	0.145 3.68
10	3.0 76.2	0.522 13.25	0.844 21.43	0.145 3.68
12	3.5 88.9	0.522 13.25	1.000 25.4	0.145 3.68
14	3.5 88.9	0.522 13.25	1.125 28.57	0.145 3.68
16	3.5 88.9	0.522 13.25	1.250 31.75	0.145 3.68
20	4.0 101.6	0.584 14.83	1.500 38.1	0.145 3.68
22	4.0 101.6	0.584 14.83	1.625 41.27	0.145 3.68
24	4.0 101.6	0.617 15.67	1.750 44.45	0.171 4.34

812

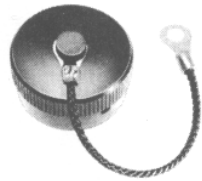

62GB-812
BS9522-F0017-A2013

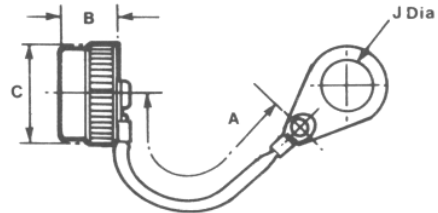

Caps and cords for flange mounting receptacles.

Shell Size	A ± 0.25 (± 6.35)	B ± 0.005 (± 0.13)	C dia max	J ± 0.003 (± 0.08)
08	3.0 76.2	0.521 13.23	0.734 18.64	0.145 3.68
10	3.0 76.2	0.521 13.23	0.859 21.82	0.145 3.68
12	3.5 88.9	0.521 13.23	1.000 25.4	0.145 3.68
14	3.5 88.9	0.521 13.23	1.125 28.57	0.145 3.68
16	3.5 88.9	0.521 13.23	1.250 31.75	0.145 3.68
18	3.5 88.9	0.521 13.23	1.375 34.92	0.145 3.68
20	4.0 101.6	0.521 13.23	1.500 38.1	0.145 3.68
22	4.0 101.6	0.521 13.23	1.625 41.27	0.145 3.68
24	4.0 101.6	0.556 14.12	1.750 44.45	0.171 4.34

Accessories

813



62GB-813
BS9522-F0017 A2014

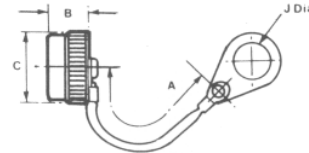

Caps and cords for single hole mounting receptacles.

Shell Size	A ± 0.25 (± 6.35)	B ± 0.005 (± 0.13)	C max	J + 0.010 (+ 0.25)
08	3.0	0.521	0.734	0.578
	76.2	13.23	18.64	14.68
10	3.0	0.521	0.859	0.703
	76.2	13.23	21.82	17.86
12	3.5	0.521	1.000	0.891
	88.9	13.23	25.4	22.63
14	3.5	0.521	1.125	1.016
	88.9	13.23	28.57	25.81
16	3.5	0.521	1.250	1.141
	88.9	13.23	31.75	29.39
18	3.5	0.521	1.375	1.266
	88.9	13.23	34.92	32.16
20	4.0	0.521	1.500	1.391
	101.0	13.23	38.1	35.33
22	4.0	0.521	1.625	1.516
	101.6	13.23	41.27	38.56
24	4.0	0.556	1.750	1.641
	101.6	14.12	44.45	41.68

814

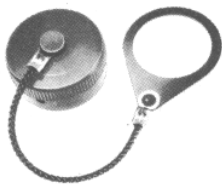

62GB-814

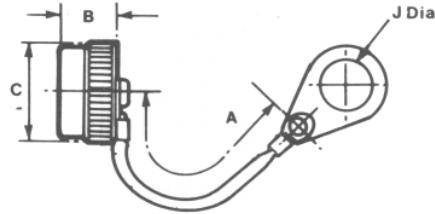

Caps and cords for cable mounting receptacles.

Shell Size	A ± 0.25 (± 6.35)	B ± 0.005 (± 0.13)	C max	J +0.010 (+ 0.25)
08	3.0	0.521	0.734	0.453
	76.2	13.23	18.64	11.50
10	3.0	0.521	0.859	0.578
	76.2	13.23	21.82	14.64
12	3.5	0.521	1.000	0.703
	88.9	13.23	25.4	17.85
14	3.5	0.521	1.125	0.891
	88.9	13.23	28.57	22.63
16	3.5	0.521	1.250	1.016
	88.9	13.23	31.75	25.80
18	3.5	0.521	1.375	1.141
	88.9	13.23	34.92	28.98
20	4.0	0.521	1.500	1.266
	101.6	13.23	38.1	32.15
22	4.0	0.521	1.625	1.391
	101.6	13.23	41.27	35.33
24	4.0	0.556	1.750	1.516
	101.6	14.12	44.45	38.50

Accessories

997



62GB-997

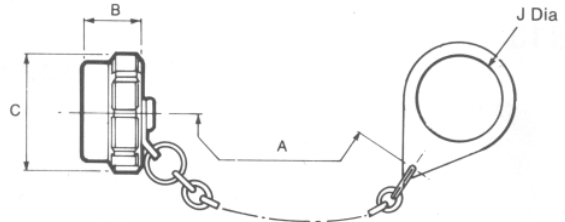

Caps and chains ribbed for single hole mounting receptacles.

Shell Size	A ± 0.25 (± 6.35)	B ± 0.005 (± 0.13)	C dia max	J + 0.010 (+ 0.25)
08	3.0 76.2	0.521 13.23	0.892 22.66	0.578 14.69
10	3.0 76.2	0.521 13.23	1.017 26.84	0.703 17.86
12	3.5 88.9	0.521 13.23	1.142 29.01	0.891 22.64
14	3.5 88.9	0.521 13.23	1.267 32.19	1.016 25.81
16	3.5 88.9	0.521 13.23	1.454 36.94	1.141 28.99
18	3.5 88.9	0.521 13.23	1.563 39.70	1.266 32.16
20	4.0 101.6	0.521 13.23	1.687 42.85	1.391 35.34
22	4.0 101.6	0.521 13.23	1.797 45.65	1.516 38.51
24	4.0 101.6	0.556 14.12	1.922 48.82	1.641 41.69

998



62GB-998

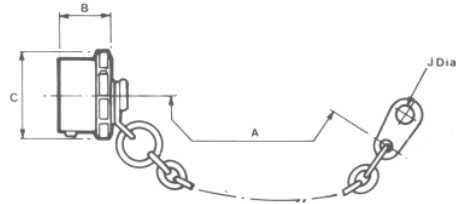

Caps and chains ribbed for plugs.

Shell Size	A ± 0.25 (± 6.35)	g max	C dia max	J ± 0.005 (± 0.13)
08	3.0 76.2	0.562 14.28	0.892 22.66	0.125 3.18
10	3.0 76.2	0.562 14.28	1.017 25.84	0.125 3.18
12	3.5 88.9	0.562 14.28	1.142 29.01	0.125 3.18
14	3.5 88.9	0.562 14.28	1.267 32.19	0.125 3.18
16	3.5 88.9	0.562 14.28	1.454 36.94	0.125 3.18
18	3.5 88.9	0.562 14.28	1.563 39.70	0.125 3.18
20	4.0 101.6	0.624 15.85	1.687 42.85	0.125 3.18
22	4.0 101.6	0.624 15.85	1.797 45.65	0.125 3.18
24	4.0 101.6	0.624 15.85	1.922 48.82	0.147 3.74

Accessories

1069



62GB-1069

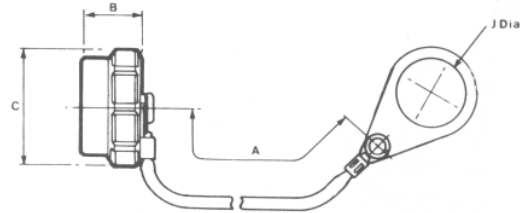

Caps and cords ribbed for single hole mounting receptacles.

Shell Size	A ± 0.25 (± 6.35)	B ± 0.005 (± 0.13)	C dia max	J + 0.010 (+ 0.25)
08	3.0 76.2	0.521 13.23	0.892 22.66	0.578 14.69
10	8.0 76.2	0.521 13.23	1.017 26.84	0.703 17.86
12	3.5 88.9	0.521 13.23	1.142 29.01	0.891 22.64
14	3.5 88.9	0.521 13.23	1.267 32.19	1.016 25.81
16	3.5 88.9	0.521 13.23	1.454 36.94	1.141 28.99
18	3.5 88.9	0.521 13.23	1.563 39.70	1.266 32.16
20	4.0 101.6	0.521 13.23	1.687 42.85	1.391 35.34
22	4.0 101.6	0.521 13.23	1.797 45.65	1.516 38.51
24	4.0 101.6	0.556 14.12	1.922 48.82	1.641 41.686

1070



62GB-1070

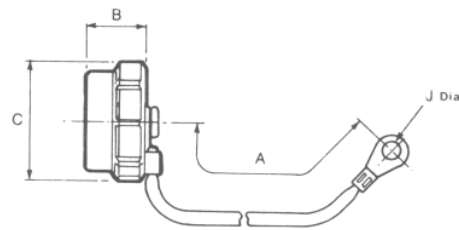

Caps and cords ribbed for flange mounting receptacles.

Shell Size	A ± 0.25 (± 6.35)	B ± 0.005 (± 0.13)	C Dia max	J ± 0.005 (± 0.13)
08	3.0 76.2	0.521 13.23	0.892 22.66	0.117 3.03
10	3.0 76.2	0.521 13.23	1.017 22.66	0.119 3.03
12	3.5 88.9	0.521 13.23	1.142 29.01	0.119 3.03
14	3.5 88.9	0.521 13.23	1.267 32.19	0.119 3.03
16	3.5 88.9	0.521 13.23	1.454 36.94	0.119 3.03
18	3.5 88.9	0.521 13.23	1.563 39.70	0.119 3.03
20	4.0 101.6	0.521 13.23	1.687 42.85	0.119 3.03
22	4.0 101.6	0.521 13.23	1.797 45.65	0.119 3.03
24	4.0 101.6	0.556 14.12	1.922 48.82	0.147 3.74

Accessories

760

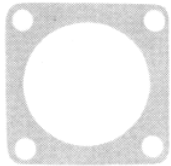

62GB-760

Flange mounting gasket for box mounting and hermetic receptacles.

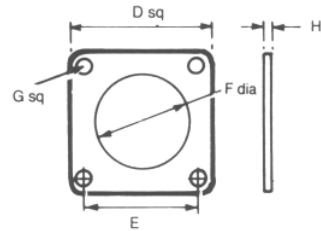











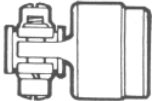

Shell Size	0 ± 0.010 (± 0.254)	E ± 0.010 (± 0.254)	F ± 0.008 (± 0.20)	G + 0.010 (+ 0.254)	H
08	0.812	0.594	0.508	0.130	0.042 / 0.016
	20.62	15.08	12.90	3.30	1.06 / 0.40
10	0.938	0.719	0.633	0.130	0.042 / 0.016
	23.82	18.26	16.07	3.30	1.06 / 0.40
12	1.031	0.813	0.758	0.130	0.042 / 0.016
	26.18	20.65	19.25	3.30	1.06 / 0.40
14	1.125	0.906	0.883	0.130	0.042 / 0.016
	28.57	23.01	22.42	3.30	1.06 / 0.40
16	1.219	0.969	1.008	0.130	0.042 / 0.016
	30.96	24.61	25.60	3.30	1.06 / 0.40
18	1.312	1.063	1.133	0.130	0.042 / 0.016
	33.32	27.00	28.77	3.30	1.06 / 0.40
20	1.438	1.156	1.258	0.130	0.042 / 0.016
	36.52	29.36	31.95	3.30	1.06 / 0.40
22	1.563	1.250	1.383	0.130	0.042 / 0.016
	39.70	31.75	35.13	3.30	1.06 / 0.40
24	1.688	1.375	1.508	0.156	0.042 / 0.016
	42.87	34.92	38.30	3.96	1.06 / 0.40

Cable Accessories

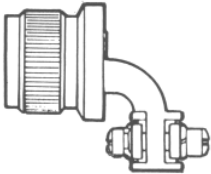
Table of Styles

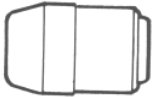

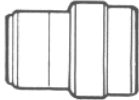
Page No.

62GB-584			51
62GB-585			51
62GB-586			52
62GB-587			52
62GB-711			53
62GB-720			53
62GB-776			54

Cable Accessories

Table of Styles

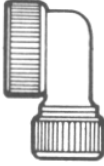
Page No.

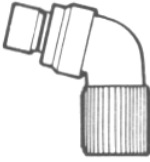
62GB-1225			54
62GB-5028			55

Cable Accessories

584

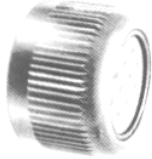

62GB - 584 - XX - XXS or P
BS 9522 FOO 17 A2102

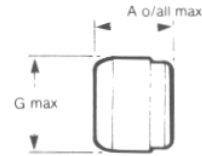

Grommet seal and nut. Provides an environmental seal for the exposed solder buckets in the openback class T shells.

Suffix XX - XXS or P enables grommet to be matched to the insert arrangement.

Shell Size	A	G max
08	0.545	0.561
	13.84	14.25
10	0.545	0.686
	13.84	17.43
12	0.545	0.811
	13.84	20.60
14	0.545	0.936
	13.84	23.78
16	0.545	1.061
	13.84	26.95
18	0.545	1.186
	13.84	30.13
20	0.545	1.311
	13.84	33.30
22	0.545	1.436
	13.84	36.75
24	0.501	1.561
	12.73	39.65

585



62G B - 585 - XX - XXS or P
BS9522 FOO 17 A2103

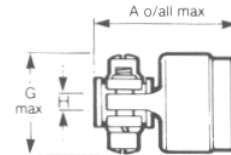

Grommet and nut with strain relief clamp. The clamp prevents the flexing of the wires in the immediate vicinity of the risers, so avoiding the risk of leaks.

Suffix XX - XXS or P enables grommet to be matched to the insert arrangement.

Shell Size	A max	G max	max
08	0.991	0.828	0.161
	25.17	21.03	4.09
10	0.991	0.891	0.193
	25.17	22.63	4.90
12	0.991	1.016	0.317
	25.17	25.81	8.05
14	0.965	1.141	0.380
	24.51	28.98	9.65
16	1.105	1.203	0.505
	28.07	30.56	12.83
18	1.105	1.426	0.630
	28.07	36.22	16.00
20	1.285	1.426	0.630
	32.64	36.22	16.00
22	1.285	1.567	0.755
	32.64	39.80	19.18
24	1.373	1.735	0.805
	34.88	44.07	20.45

Cable Accessories

586

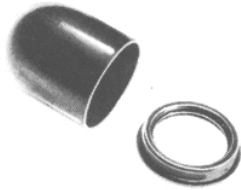

62G B - 586 - XX

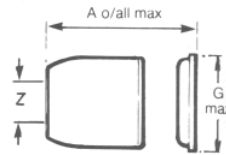

Potting mould and ring,
supplied together as a set.

Suffix XX specifies shell size.

Shell Size	A max	G max	Z min
08	0.644	0.585	0.260
	16.36	14.85	6.60
10	0.753	0.679	0.463
	19.13	17.24	11.76
12	0.722	0.835	0.557
	18.34	21.20	14.14
14	0.722	0.913	0.590
	18.34	23.19	14.98
16	0.722	1.038	0.713
	18.34	26.36	18.11
18	0.722	1.163	0.835
	18.34	29.54	21.20
20	0.877	1.288	1.015
	22.30	32.71	25.78
22	0.877	1.413	1.015
	22.30	35.89	25.78
24	0.896	1.538	1.263
	22.76	39.06	32.08

587



62G B - 587 - XX - XXS or P

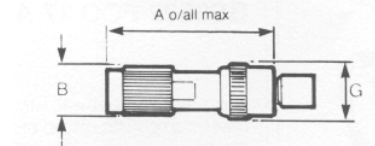

Clamp for screened jacketed cable. 62 Series only with grommet. Effective sealing is provided over the range of cables covered by DEF 10(Pattern C) and DEF STAN 61-12 port (see table). These are supplied to separate order only for use with style T shells.

Suffix XX-XXS or P enables grommet to be matched to the insert arrangement.

Shell Size	length Including plug	A Max	length Including receptacle	B max	G max
08	2.732	2.742	2.742	0.676	0.775
	69.39	69.64	69.64	17.17	19.68
10	2.742	2.752	2.752	0.676	0.902
	69.64	69.90	69.90	17.17	22.91
12	3.152	3.162	3.162	0.812	1.030
	80.06	80.31	80.31	20.62	26.16
14	3.152	3.162	3.162	0.926	1.157
	80.06	80.31	80.31	23.52	29.39
16	3.272	3.282	3.282	1.051	1.284
	83.10	83.36	83.36	26.67	32.61
18	-	-	-	-	-
	-	-	-	-	-
20	3.272	3.345	3.345	1.280	1.539
	83.10	84.96	84.96	32.51	39.09
22	-	-	-	-	-
	-	-	-	-	-
24	3.696	3.768	3.768	1.620	1.783
	93.87	95.70	95.70	41.15	45.29

Cable Accessories

711



62G B - 711 - XX - XXS or P

Grommet and nut with right angled strain relief clamp. The clamp prevents flexing of the wires in the immediate vicinity of the risers, so avoiding the risk of leaks (these are supplied to separate order only for use with style T shells).

Suffix XX - XXS or P enables grommet to be matched to the insert arrangement.

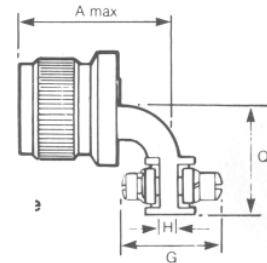

Shell Size	A max	G max	H ± 0.005 ± 0.13	Q max
08	1.5/32	0.828	0.161	0.733
		21.03	4.09	18.62
10	1.3/16	0.891	0.193	0.795
		22.63	4.90	20.19
12	1.7/32	1.016	0.317	0.858
		25.81	8.05	21.79
14	1.1/4	1.141	0.380	0.915
		28.98	9.65	23.24
16	1.5/16	1.203	0.505	1.010
		30.56	12.83	25.65
18	1.3/8	1.426	0.630	1.070
		36.22	16.00	27.18
20	1.3/8	1.426	0.630	1.140
		36.22	16.00	28.96
22	1.29/64	1.567	0.755	1.170
		39.80	19.18	29.72
24	1.15/32	1.735	0.805	1.260
		44.07	20.45	32.00

720

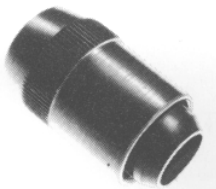

62G B - 720 - XX

Clamp for unscreened jacketed cable. No grommet is supplied, for use with 50T, 51T and 56T styles.

Suffix XX specifies shell size.

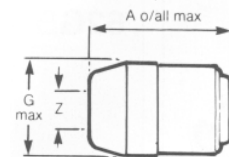

Shell Size	A max	G max	Z closed	Z free
08	1.085	0.561	0.168	0.230
	27.56	14.25	4.28	5.84
10	1.060	0.686	0.205	0.312
	26.92	17.43	5.21	7.93
12	1.160	0.811	0.338	0.442
	29.46	20.60	8.59	11.23
14	1.360	0.936	0.416	0.539
	34.54	23.78	10.57	13.69
16	1.585	1.061	0.550	0.616
	40.26	26.95	13.97	15.65
18	1.785	1.186	0.600	0.672
	45.34	30.13	15.24	17.57
20	1.981	1.311	0.635	0.747
	50.32	33.30	16.13	18.98
22	2.181	1.436	0.670	0.846
	55.39	36.75	17.02	21.49
24	2.216	1.561	0.740	0.894
	56.28	39.65	18.80	22.71

Cable Accessories

776



62GB - 776

General duty shell to accept conduit, AN 3057 or MS 3057 A cable clamps and heat shrink sleeves.

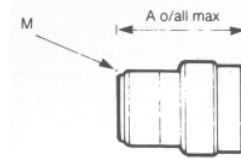

Shell Size	A max	M Thread
08	0.937	1/2 - 28 UNEF
	23.80	
10	0.937	5/8 - 24 NEF
	23.80	
12	0.937	3/4 - 20 UNEF
	23.80	
14	0.937	7/8 - 20 UNEF
	23.80	
16	0.937	1 - 20 UNEF
	23.80	
18	0.937	1.3/16 - 18 NEF
	23.80	
20	0.937	1.3/16 - 18 NEF
	23.80	
22	0.937	1.7/16 - 18 NEF
	23.80	
24	0.937	1.7/16 - 18 NEF
	23.80	

1225

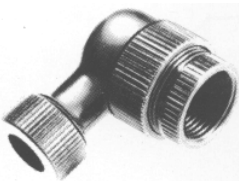

62GB - 1225

90 clamp for screened jacketed cable. These are supplied to separate order only for use with style T shells.

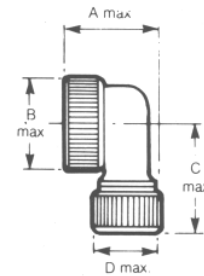

Shell Size	A max	B max	C max	D max
08	0.942	0.821	1.160	0.636
	23.93	20.85	29.46	16.15
10	0.883	0.821	1.160	0.636
	22.43	20.85	29.46	16.15
12	0.704	0.821	1.160	0.636
	17.88	20.85	29.46	16.15
14	1.119	0.937	1.160	0.636
	28.42	23.80	29.46	16.15

Cable Accessories

5028

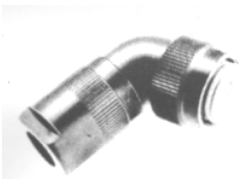

62G B - 5028 - XX - XXS or P

75% Clamp for screened jacketed cable with grommet. Effective sealing is provided over the range of cables covered by DEF 10 (Pattern C) and DEF STAN 61 - 12 part 5 (see table). These are supplied to separate order only and are intended for use with style T shells.

Suffix XX-XXS or P enables grommet to be matched to the insert arrangement.

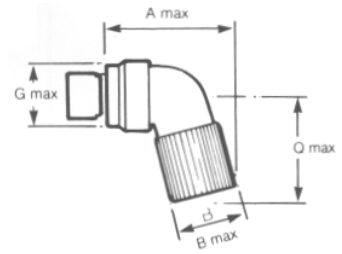

Shell Size	length including receptacle	A Max	length including plug	B max	G max	max
08	2.416 61.37		2.375 60.24	0.676 17.17	0.775 19.68	1.750 44.45
10	2.573 65.35		2.532 64.39	0.676 17.17	0.902 22.91	1.875 47.63
12	2.666 67.72		2.625 66.68	0.812 20.62	1.030 26.16	2.125 53.98
14	2.760 70.10		2.719 69.04	0.926 23.52	1.157 29.39	2.125 53.98
16	2.790 70.87		2.750 69.80	1.051 26.70	1.284 32.61	2.062 52.38
18	-		-	-	-	-
20	3.312 84.13		3.250 82.55	1.280 32.51	1.539 39.09	2.062 52.38
22	-		-	-	-	-
24	3.500 88.90		3.375 85.73	1.620 41.15	1.783 45.29	2.187 55.55

