



***Hoffman Tools -  
The Right Solution For  
Your Crimping, Cutting  
and Stripping Needs.***

Since 1963, Hoffman has been supplying quality tools to the manufacturer, distributor, and electrical contractor to accompany its line of solderless terminals and connectors. We are dedicated to providing you with the highest quality products, a program for financing your tooling, and superior service.

***Crimping Tools***

PAGE

---

The Crimping Process . . . . .	3
Crimp Tool Selector Chart . . . . .	4-5
Plier Type Tools . . . . .	6
Ratchet Tools . . . . .	7-10
Heavy Duty Lever Type Tools . . . . .	11
Hydraulic Tools . . . . .	12-14
Pneumatic Tools . . . . .	15-17
Automatic Processing . . . . .	18

***Cutting & Wire Stripping  
Tools & Crimp Kits***

---

Hand Tools . . . . .	19
Electric . . . . .	20
Kits . . . . .	20

***Index***

---

Numerical Index . . . . .	22
---------------------------	----





## HOFFMAN PRODUCTS

20700 Hubbell Avenue  
Oak Park, MI 48237  
Tel: 1-800-645-2014  
1-248-395-8462  
Fax: 1-800-908-1295  
1-248-967-6399  
[www.hoffmanproducts.com](http://www.hoffmanproducts.com)



### Terms & Conditions of Sale

MINIMUM ORDER: \$50.00

PAYMENT TERMS: Net 30 days (subject to credit approval)  
Visa, Mastercard, Discover accepted, C.O.D.

TRANSPORTATION TERMS: Standard UPS freight will be prepaid and added to billing.  
F.O.B. Holbrook, NY or Chicago, IL.

CLAIMS AND ERRORS: All claims for shipping or pricing errors must be submitted  
in writing within 45 days of the invoice date.

RETURN GOODS: All return goods must be approved by Hoffman prior to return.  
No returns will be accepted without written authorization. A 20% restocking  
charge may be imposed on applicable returns.

CANCELLATION: Order placed cannot be cancelled without the written consent of  
Hoffman and upon terms which will indemnify the company against all losses.

SALES TAX: Any tax imposed by law on the sale of articles will be added to the  
sales price.

ALL PRICES ARE SUBJECT TO CHANGE WITHOUT NOTICE.

### Lease Terms and Conditions

Equipment leased by Hoffman is subject to Hoffman's approval and title remains the  
property of Hoffman Products. Consignee agrees to pay all shipping costs, replace  
damaged parts, (excluding normal wear), use only Hoffman products in the equip-  
ment, assume full responsibility for any injuries or damage sustained while equip-  
ment is at Consignee location, and permit Hoffman right of access to designated facil-  
ity during normal business hours for purposes of inspection.

### Warranty and Disclaimer

There are no express warranties which extend beyond the description on the face  
hereof. SELLER DISCLAIMS ANY IMPLIED WARRANTIES OF MERCHANTABILITY OR  
OF FITNESS FOR ANY PARTICULAR PURPOSE. Since Seller cannot control the man-  
ner or use of its products after their sale, Seller will not be responsible for any con-  
sequential or indirect damages. Rather, Seller will, at its own option either replace the  
products sold or refund the purchase price. No warranties will apply if the products  
are in any way altered or modified after delivery by Seller.



***Selection of the appropriate tool is essential in obtaining a proper crimp.***

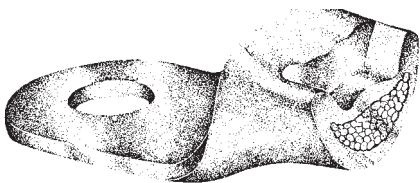
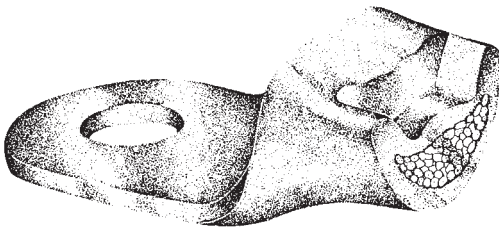
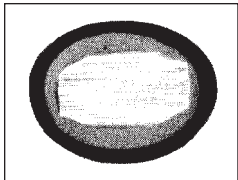
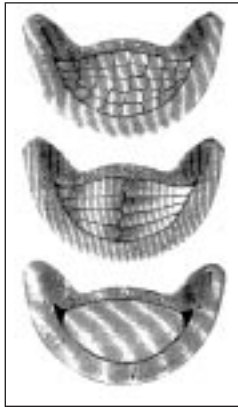

## ***Homogeneity***

In a perfect crimp, the conductor blends with the terminal barrel to form one solid mass, without any air voids.

## ***Perfection***

Hoffman's crimp concept is based on extensive design and experimentation. Optimal crimp configuration results from a reduction of the terminal barrel and wire to approximately 75% of the original configuration. It is also desirable to maintain the material thickness of the barrel after crimping. Hoffman tools offer crimp uniformity whether you use solid, stranded, round or flat cable.

## ***Crimp Types***

### ***"O" Crimp***

For non-insulated terminals and connectors, the "O" shape produces a homogeneous blending of the terminal barrel and conductor to provide maximum conductivity, corrosion resistance, and greatest tensile strength

### ***"H" Crimp***

For insulated terminals and connectors, the "H" type yields an outstanding crimp configuration. Unlike bare or uninsulated terminals, crimping is done through the insulation (vinyl or nylon). The jaws of the tool are designed so that they will permit even "flow" of the insulation without piercing, cracking, burring or causing flash formation. The "H" crimp type maintains uniform pressure during the crimping cycle, resulting in a uniform hexagonal cross section.



# CRIMPING TOOL SELECTOR CHART

## NON-INSULATED TERMINALS & SPLICES

HAND TOOLS				HYDRAULIC TYPE							PNEUMATIC (AIR) TYPE							
Wire Size	Plier Type	Ratchet Type	Lever Type	Hand Pumped Tool Part #		Power Activated Crimping Head Part #					Pneumatic Tool Part # <i>Crimping dies are ordered separately &amp; listed below</i>							
				608	604	603	607	609	610	611T	ACS300	AC5N	YA1	YA2	YA4	YA5		
2622		YHT2622												AD100	AD500			
2216	Y801 Y401	YHM61 YHT2210 YHM228												AC1	AD101	AD501	AD900	
1614	Y801 Y401	YHM61 YHM88 YHT2210 YHM228												AC1	AD101	AD501	AD900	
1210	Y801 Y401	YHM61 YHM88 YHT2210 YHM228		Crimping dies for hydraulic tools are purchased individually for specific wire size crimping needs. Crimping die part numbers are listed below.									AC1	AD101	AD501	AD900		
8		YHM61 YHM88 YHM228	AK38 111	60801 60802	R O T A R Y  N E S T  T O O L  6AWG TO 4/0	60301 60313	60601 60602			60801 60802						AD901	AD951	
6		YHT88 YHM88 YHT14S	AK38 AK60 111 115	60803 60802		60302 60313	60603 60602			60803 60902							AD902	AD952
4			AK38 AK60 111 115	60804 60805		60303 60314	60804 60805			60804 60805								AD953
2			AK38 AK60 111 115	60806 60805		60304 60314	60606 60605			60806 60805								AD954
1/0			115	60807 60808		60305 60314	60607 60608	60901 60902		60807 60808								AD955
2/0			115	60809 60808		60306 60315		60903 60902		60809 60808								
3/0			115	60810 60811		60307 60315		60904 60905		60810 60811								
4/0			115	60812 60811		60308 60315		60906 60905		60812 60811								
300 MCM				60813 60814		60309 60316		60907 60908		60813 60814								
350 MCM						60310 60316		60909 60908										
400 MCM					60311 60316		60910 60911											
600 MCM					60312 60316		60912 60913											

## NON-INSULATED WITH A COPPER SLEEVE

2216		YDT2216															AD921F
1614		YDT1614															AD922F
1210		YDT1210S															AD923F

## NON-INSULATED OPEN BARREL QUICK DISCONNECTS

2622		YHF200												F200			
2216	PF2010	YHF200 YOM2210												F200			
1614	PF2010	YHF200 YOM2210												F200			
1210		YOM2210															

## NON-INSULATED FLAG TERMINALS

2216		YG2216															AD941
1614		YG1614															AD942
1210		YG1210															AD943
8		YG8S															AD944
6																	AD945 AD951G
4																	AD946 AD952G
2																	AD953G
1/0																	AD954G
2/0																	AD955G



# CRIMPING TOOL SELECTOR CHART

## INSULATED TERMINALS AND CONNECTORS

HAND TOOLS				HYDRAULIC TYPE						PNEUMATIC (AIR) TYPE									
Wire Size	Plier Type	Ratchet Type	Lever Type	Hand Pumped Tool Part #		Power Activated Crimping Head Part #				Pneumatic Tool Part # <i>Crimping dies are ordered separately &amp; listed below</i>									
				608	604	603	607	609	610	611T	ACS300	AC5N	YA1	YA2	YA4	YA5			
2622		YNT2622																	
2216	Y801 Y401	YNT2216 YNM112 YNM126 YNM2210 YNM2210D											AC3	AD201F	AD601F	AD911F			
1614	Y801 Y401	YNT2216 YNM112 YNM123 YNT1614 YNM2210 YNM2210D YNM126											AC4	AD202F	AD602F	AD9121F			
1210	Y801 Y401	YNT1210S YNM123 YNM126 YNM2210 YNM2210D											AC5			AD913F			
8			111							61001 61002									
6			111							61003 61004									
4			111							61005 61006									
2			111							61007 61008									

## CLOSED END CONNECTORS

2218		YS2216 YS7 YS2210										ADCEA	AC7A	AD301	AD801	AD931			
1614		YS7 YS2210 YS2210S										ADCEB	AC7A	AD302	AD802	AD932			
1210		YS7 YS2210										ADCED	AC7A	AD303	AD803	AD933			
8		YS8S														AD934			

## INSULATED FLAG DISCONNECTS

2216	FG6100	YNG2214																	
1614	FG6100	YNG2214																	
1210	FG6100																		

## FERRULES

10-6		YFE106																	
22-12		YFE2212																	
8-4		YFE84																	

## How To Select The Proper Crimping Tool

- 1 Locate the terminal style you wish to crimp.
- 2 Determine the wire size you wish to crimp.
- 3 Once the terminal style and wire sizes are determined, look across the tool selector chart and choose the appropriate crimping tool for your application, e.g., hand tool, pneumatic tool or hydraulic tool.
- 4 Refer to the numerical index on page 22 for detailed information on the crimping tool you have selected.



HOFFMAN PRODUCTS

hoffmanproducts.com • 1-800-645-2014

## PLIER TYPE HAND TOOLS

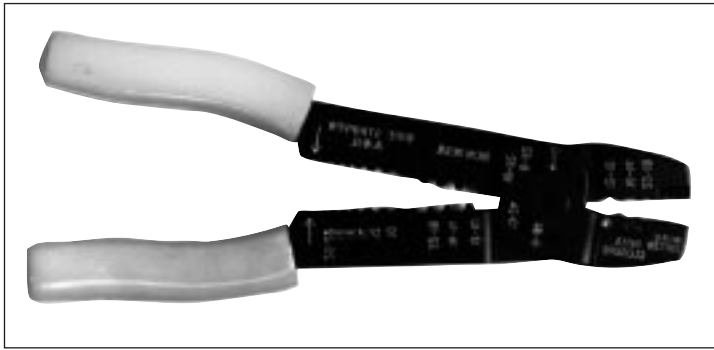

### Y801 Plier Type

**Features:**

- Crimps 22-16, 16-14, 12-10 non-insulated and insulated terminals
- Wire Cutter - Cuts wire cleanly and quickly
- Insulation Stripper - Strips sizes 22-10 AWG
- Bolt Cutter - Cuts 5 popular bolt sizes 4-40, 6-32, 8-32, 10-24, 10-32
- Thread Chaser - cleans and chases threads for bolt sizes above
- Professional Quality - made from milled steel to ensure accurate operation and long life as opposed to stamped tools
- Comfort vinyl cushion grip handles - alleviates operator hand fatigue
- Weight: 8 oz. • Length: 9"

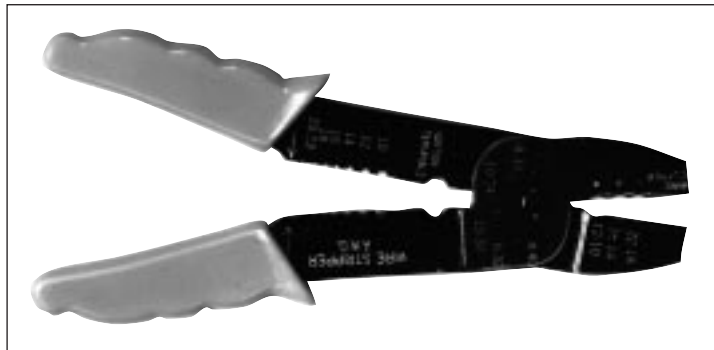

### Y401 Plier Type

**Features:**

- Crimps 22-16, 16-14, 12-10 non-insulated and insulated terminals
- Wire Cutter - cuts wire cleanly and quickly
- Insulation Stripper - Strips 22-10 AWG
- Bolt Cutter - cuts 5 popular bolt sizes 4-40, 6-32, 8-32, 10-24, 10-32
- Thread chaser cleans and chases threads for above bolt sizes
- Molded vinyl grip handles
- Weight: 7 oz. • Length: 8"

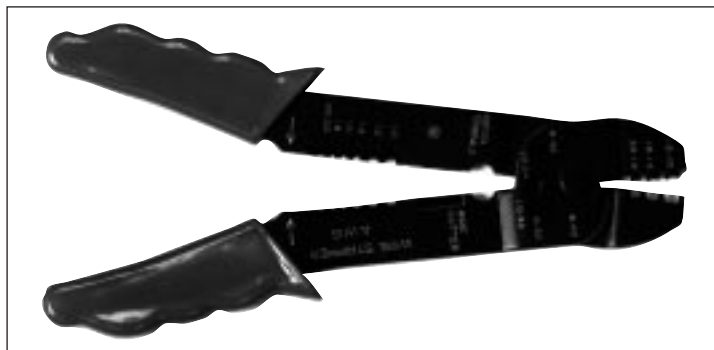

### PF2010 Plier Type

**Features:**

- Crimps open barrel non-insulated terminals 22-14 AWG
- 3 dies to crimp 22-16, 16-14 and the wire insulation support
- Wire Cutter - cuts wire cleanly and quickly
- Wire Stripper - for sizes 22-10 AWG
- Bolt Cutter - for sizes 4-40, 6-32, 8-32, 10-24, 10-32.
- Molded vinyl grip handles
- Weight: 7 oz. • Length: 8"

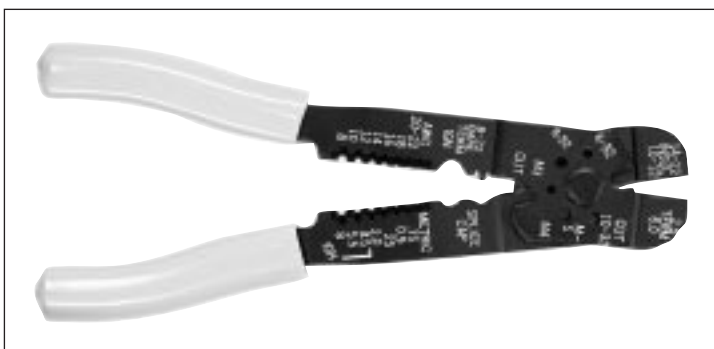

### FG6100 Plier Type

**Features:**

- Crimps non-insulated flag disconnects 22-10
- Molded vinyl grip handles
- Bolt Cutter - for sizes 4-10, 6-32, 8-32, 10-24, 10-32
- Wire Stripper - for sizes 22-8 AWG



# RATCHET TYPE CRIMPING TOOLS

## For Non-Insulated Terminals

These quality tools are intended for professional use. All ratchet tools provide a "controlled crimp". The crimp cycle must be completed or the tool will not release. This prevents over crimping or under-crimping of the terminal or connector. All tools have spring loaded handles which provide automatic release after the crimp cycle has been completed.

### YHT TYPE

Strong durable slim handled tools with a baked enamel finish. Each has a high polished nest and indenter for precision quality crimping.

Part No.	AWG Range	Length	Weight
YHT2622	26-22	10.5"	1 lb.
YHT2210	22-10	12"	1 lb.
YHT8S	8	12"	2 lb.
YHT14S	6	12"	2 lb.



### YHM TYPE

The YHM type tools are designed with multiple dies to crimp a large range of terminal sizes. Type 1 features strong plastic handles that are easy on the hands, while type 2 has soft vinyl grip handles.

Part No.	AWG Range	Length	Weight
YHM228	22-8	10"	1.5 lb.



Part No.	AWG Range	Length	Weight
YHM61	22-8	10.25"	1 lb.
YHM88	16-6	11.25"	1 lb.

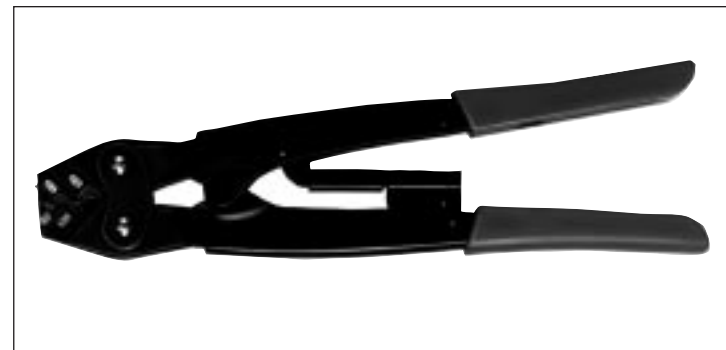

*High Quality, Low Price...the best combination for a cost conscious production department.*



HOFFMAN PRODUCTS

hoffmanproducts.com • 1-800-645-2014

# RATCHET TYPE CRIMPING TOOLS



## For Non-Insulated Flag Terminals

Strong Durable, Slim handled tools with a black enamel finish.

Part No.	AWG Range	Length	Weight
YG2216	22-16	10.75"	1 lb.
YG1614	16-14	10.75"	1 lb.
YG1210	12-10	10.75"	1 lb.
YG8S	8	12.25"	2 lb.



## For Non-Insulated Terminals with a barrel support sleeve

Strong, durable slim handled tool with spring loaded wire stop tab which automatically adjusts to different size and shape of terminals. Adjustable support sleeve setting feature: (#1 small OD, #2 for medium OD, #3 for large OD).

Part No.	AWG Range	Length	Weight
YDT2216	22-16	10.75	1.25 lb.
YDT1614	16-14	10.75	1.25 lb.
YDT1210	12-10	13"	2.25 lb.



## For Non-Insulated Open Barrel Connectors

Light easy ratchet mechanism with plastic grip handles. Assures a good double crimp on all open barrel connectors. Crimps both the stripped wire and the insulation support in one operation.

Part No.	AWG Range	Length	Weight
YOM2210	22-10	10"	1 lb.



Strong, durable slim handled tool with vinyl grip handle. Crimps both the stripped wire and insulation support in one operation.

Part No.	AWG Range	Length	Weight
YHF200	22-14	10.75"	1 lb.





# RATCHET TYPE CRIMPING TOOLS

## For Insulated Terminals

### YNM Type

The YNM tools produce a controlled double crimp, securing a perfect crimp on both the barrel and insulation part of the terminal. Nickel chrome plated molybdenum steel jaws with two crimp sections. Type 1 has color coded handles while type II has color coded dies to assure using the appropriate die for each wire size terminal.

Part No.	AWG	Length	Weight	Die Color
YNM112	22-14	11"	1 lb.	Red/Blue
YNM123	16-10	11"	1 lb.	Blue/Yellow

Part No.	AWG	Length	Weight	Die Color
YNM126	22-10	9"	1lb.4 oz.	Red/blue/yellow
YNM2210	22-10 Single Crimp	10"	1lb.8 oz.	Red/blue/yellow
YNM2210D	22-10	10"	1 lb.8 oz.	Red/blue/yellow

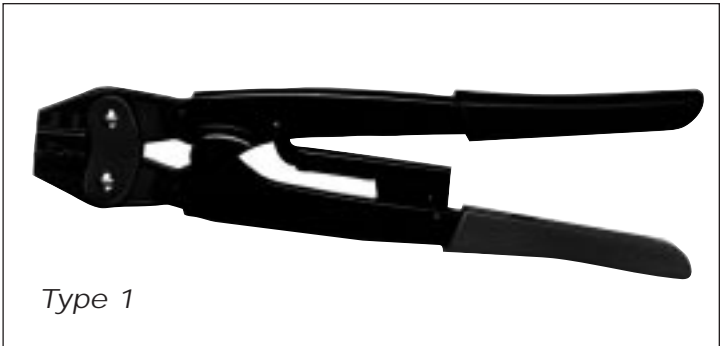

### YNT Type

The YNT tools produce a controlled double crimp. A spring loaded wire stop tab automatically adjusts to different sizes and shapes of terminals. Tab prevents wire from protruding out of the terminal barrel while crimping. Handles are color coded for easy identification of wire ranges.

Part No.	AWG	Length	Weight	Handle Color
YNT2622	26-22	10.75"	1.25 lb.	Yellow
YNT2216	22-16	10.75"	1.25 lb.	Red
YNT1614	16-14	10.75"	1.25 lb.	Blue
YNT1210S	12-10	13"	2.25 lb.	Yellow



# RATCHET TYPE CRIMPING TOOLS

## For Specialty Connectors

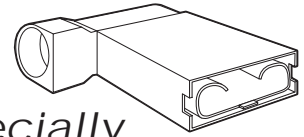

### YNG 2214 Specially Designed For Female Insulated Flag Disconnects

The unique nest design holds the terminal in place while inserting and crimping the wires. Dies for both 22-16 and 16-14 in the one tool with color coded handles and dies.

- Length 9"
- Weight: 1 lb. 3 oz.

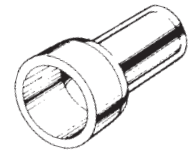

### YS Tools for Closed End Connectors

Specially designed dies in each model assures the user of a superior crimp with an extensive variety of wire combinations. Type I has green vinyl cushion handles while Type II is made with durable plastic handles and contains multi dies with color coded markings.

Part No.	AWG Range	Length	Weight	Type
YS2216	22-16	10.75"	1 lb.	1
YS1614	16-14	10.75"	1 lb.	1
YS1210	12-10	10.75"	1 lb.	1
YS8S	8	12.25"	2 lb.	1
YS7	22-10	10.75"	1 lb.	1
YS2210	22-10	10"	1.5 lb.	2

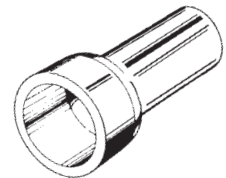

### For Ferrules

Multi-nested tools for crimping a wide range of ferrules. Easy ratchet mechanism assures a complete crimp each time.

Part No.	AWG Range	Length	Weight
YFE2212	22-12	10"	1.5 lb.
YFE84	8-4	10"	1.5 lb.
YFE106	10-6	10"	1.5 lb.



## HEAVY DUTY LEVER TYPE CRIMP TOOLS

### For Large Size Terminals and Connectors

#### AK38 & AK60 Crimp Tools

Durable, Heavy Duty Crimp tool with rotating nests. A dial down crimp process provides a staged and completed crimp on large size terminals every time. Molded plastic covered handles are comfortable on the hands. Great for use in the field.

Part No.	AWG Range	Length	Weight
AK38	8-2	24.75"	6 lb.
AK60	6-1/0	24.75"	6 lb.

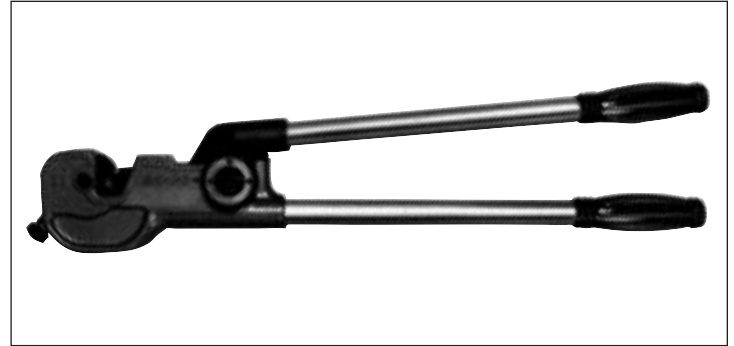

#### 111 Crimp Tool

Designed for both insulated and non-insulated terminal and connectors in wire ranges 8-2 insulated and 8-2/0 non-insulated. Wire ranges are marked on each die space. Comfortable vinyl grip handles.

- Length: 19"
- Weight: 4.5 lbs.



#### 115 Crimp Tool

Designed for crimping large size tubular lugs in wire ranges 6-4/0. Multi dies nests are conveniently attached to the handle and are easily installed for crimping the various sizes needed. Comfortable vinyl grip handles.

- Length: 17"
- Weight: 4 lbs.

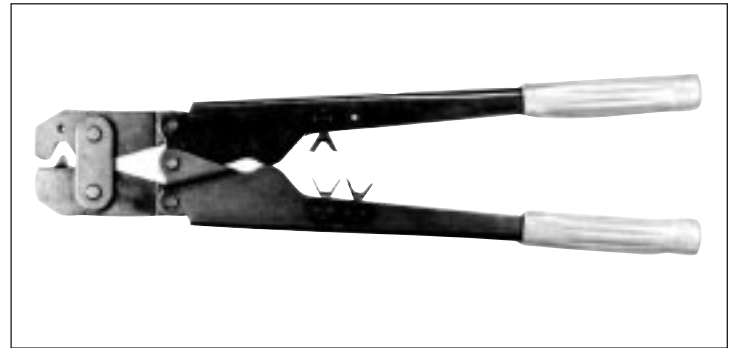

#### T640 Crimp Tool

Designed for crimping tubular lugs in wire ranges from 6-4/0. The spring action holds lugs firmly in place until crimped. Positive stop assures a consistent crimp. May be used with a hammer or vise.

- Length: 6"
- Weight: 1 lb.



HOFFMAN PRODUCTS

hoffmanproducts.com • 1-800-645-2014

# HYDRAULIC HAND TOOLS

These tools are portable, manually operated, hydraulic presses for installing terminals and connectors ranging in the larger sizes listed below. Tools develop up to 16 tons of power. Depth of indentation is automatically controlled to avoid over and undercrimping. Both are supplied with a carrying case.

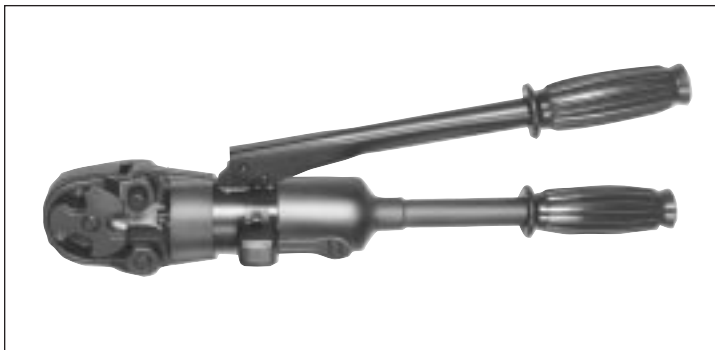

## 604 Hand Tool

This tool has a rotating swivel head nest and can be operated either vertically or horizontally. The unique rotating head provides a compact tool capable of crimping a wide range of large size terminals. Perfect for field work. Comes with a convenient heavy plastic carrying case.

- Length: 20"
- Weight: 9.5 lbs.

Wire Size	Nest Wheel Wire Range	Indenter Wire Range
6	6-2	6
4	6-2	4
2	6-2	2-2/0
1/0	1/0-2/0	2-2/0
2/0	1/0-2/0	2-2/0
3/0	3/0-4/0	3/0-4/0
4/0	3/0-4/0	3/0-4/0

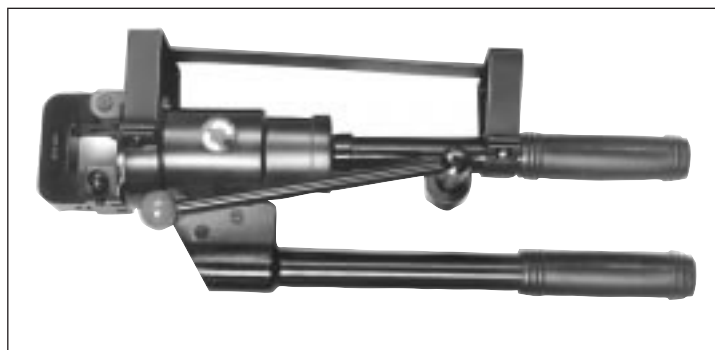

## 608 Hand Tool

This tool has interchangeable nests and indentors. Dies can be quickly interchanged for different wire size operations. The tool comes with a heavy metal carrying case. Dies are ordered separately.

- Length: 20"
- Weight: 17.5 lbs.

Wire Size	Die Nest	Die Indenter
8	608-01	608-02
6	608-03	608-02
4	608-04	608-05
2	608-06	608-05
1/0	608-07	608-08
2/0	608-09	608-08
3/0	608-10	608-11
4/0	608-12	608-11
300MCM	608-13	608-14

*We're here to help you...  
Big or small, every customer is special to us.*



These crimping heads are designed for large size terminals & connectors in ranges from 8AWG up to 600MCM. They supply a superior "O" type crimp for maximum conductivity and tensile strength. The heads are supplied with a metal carrying case. Dies are sold separately.

## 603 Hydraulic Heads

- Weight: 18 lbs.

Wire Size	Nest No.	Indentor No.
8	60301	60313
6	60302	60313
4	60303	60314
2	60304	60314
1/0	60305	60314
2/0	60306	60315
3/0	60307	60315
4/0	60308	60315
300MCM	60309	60316
450MCM	60310	60316
400MCM	60311	60316
600MCM	60312	60316



## 607 Hydraulic Heads

- Maximum Capacity: 13M lbs.
- Weight: 4 lbs.
- Pressure: 7700 psi
- Speed: 2-3 sec./ rev.

Wire Size	Nest No.	Indentor No.
8	60601	60602
6	60603	60602
4	60604	60605
2	60606	60605
1/0	60607	60608



## 609 Hydraulic Heads

- Maximum Capacity: 79M lbs.
- Weight: 33 lbs.
- Pressure: 7000 psi
- Speed: 25-30 sec/ rev

Wire Size	Nest No.	Indentor No.
1/0	60901	60902
2/0	60903	60902
3/0	60904	60905
4/0	60906	60905
300MCM	60907	60908
350MCM	60909	60908
400MCM	60910	60911
600MCM	60912	60913



# POWER ACTIVATED HYDRAULIC HEADS



## 611T Hydraulic Heads

- Maximum Capacity: 35M lbs.
- Weight: 9.2 lbs.
- Pressure: 9800 psi
- Speed: 6-7 sec/rev

Wire Size	Nest No.	Indenter No.
8	60801	60802
6	60803	60802
4	60804	60805
2	60806	60805
1/0	60807	60808
2/0	60809	60808
3/0	60810	60811
4/0	60812	60811
300MCM	60813	60814



## 610 Hydraulic Heads

This hydraulic head is designed for large size insulated terminals. The crimping dies have 2 sections which enable crimping to be done in one operation (barrel and insulation are crimped simultaneously.) Dies and tool head are sold separately.

- Weight: 5 lbs.
- Pressure: 650kg/sq cm
- Speed: 4 sec/rev

Wire Size	Nest No.	Indenter No.
8	61001	61002
6	61003	61004
4	61005	61006
2	61007	61008

*Need a demo?  
Call us for assistance at 1-800-645-2014*



High quality tools designed to increase productivity. Both portable and bench mounted styles are available. Tools operate on standard 70-90 psi air pressure. Select appropriate jaws for each application when ordering.

## YA Series - Crimping Tools

Lightweight portable or bench mount tools for all terminal and connector types in wire ranges 26-1/0 AWG.

### YA1

• Length: 11.8" • Weight: 3.7 lbs. • Outer Diameter: 3.5"

Jaw Number	Wire Size	Terminal Type
AD100	26-22	Non-Insulated
AD101	22-10	Non-Insulated
AD201F	22-16	Insulated
AD202F	16-14	Insulated
AD203F	12-10	Insulated
AD301	22-18	Closed End Connectors
AD302	16-14	Closed End Connectors
AD303	12-10	Closed End Connectors



### YA2

• Length: 11.6" • Weight: 3.7 lbs. • Outer Diameter: 3.5"

Jaw Number	Wire Size	Terminal Type
AD500	26-22	Non-Insulated
AD501	22-10	Non-Insulated
AD600	26-22	Insulated
AD601F	22-16	Insulated
AD602F	16-14	Insulated
AD801	22-18	Closed End Connector
AD802	16-14	Closed End Connector
AD803	12-10	Closed End Connector



*Hoffman continues to deliver...  
Service, Quality and Savings.*



**HOFFMAN PRODUCTS**

hoffmanproducts.com • 1-800-645-2014

# PNEUMATIC CRIMPING TOOLS



## YA4

- Length: 7.3" • Height: 10.8" • Weight 6.6 lbs.

Jaw No.	Wire Size	Terminal Style
AD900	22-10	Non-Insulated
AD901	8	Non-Insulated
AD902	6	Non-Insulated
AD-911F	22-16	Insulated
AD-912F	16-14	Insulated
AD-913F	12-10	Insulated
AD931	22-18	Closed End Connectors
AD932	16-14	Closed End Connectors
AD933	12-10	Closed End Connectors
AD934	8	Flag Rings Non-Insulated
AD941	22-16	Flag Rings Non-Insulated
AD942	16-14	Flag Rings Non-Insulated
AD944	12-10	Flag Rings Non-Insulated
AD945	8	Flag Rings Non-Insulated
AD946	6	Flag Rings Non-Insulated



## YA5 - Pneumatic "Heavy Duty" Portable Tool

Crimps non-insulated terminals and non-insulated flag terminals 8-1/0 AWG

- Length: 11.8" • Height: 17.7" • Weight 21.5 lbs.

Jaw No.	Wire Size	Terminal Style
AD951	8	Non-Insulated
AD952	6	Non-Insulated
AD953	4	Non-Insulated
AD954	2	Non-Insulated
AD955	1/0	Non-Insulated
AD951G	8	Flag Rings Non-Insulated
AD952G	6	Flag Rings Non-Insulated
AD953G	4	Flag Rings Non-Insulated
AD-954G	2	Flag Rings Non-Insulated
AD-955G	1/0	Flag Rings Non-Insulated





## ACS300 Portable Tools

Small portable lightweight tool designed for crimping closed end connectors in wire range 22-10

- Length: 8.5" • Weight: 2 lbs.



Jaw Number	Wire Size
ADCEAB	16-14
ADCEBD	12-10

## AC5N Bench Tools

Lightweight foot operated bench tool for crimping a variety of terminals and connectors in wire range 22-10.

- Length: 7.5" • Weight: 6 lbs.



Jaw Number	Wire Size	Terminal Type
AC1	22-10	Non-Insulated
AC3	22-16	Insulated
AC4	16-14	Insulated
AC5	12-10	Insulated
AC7	22-10	Closed End Connectors
F200	22-14	Open Barrel Disconnects

*High Quality, Low Price...the best combination for a cost conscious production department.*



**HOFFMAN PRODUCTS**

hoffmanproducts.com • 1-800-645-2014

# AUTOMATIC CRIMPING MACHINE

*Economical, Fast, Safe, Automatic  
Crimping with Advanced  
State of the Art Design*

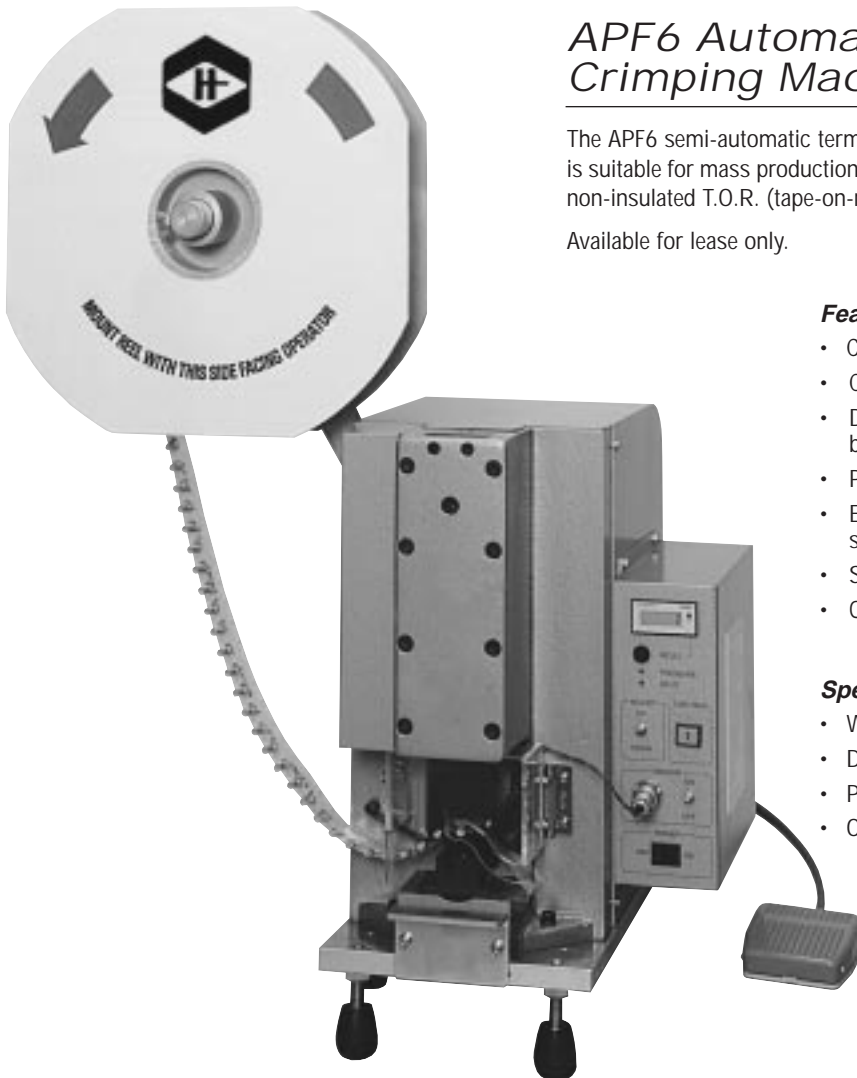

## APF6 Automatic Crimping Machine

The APF6 semi-automatic terminal-on-tape crimping machine is easy to operate, and is suitable for mass production of crimped harnesses with closed-barrel insulated and non-insulated T.O.R. (tape-on-reel) terminals in wire ranges 26-8 AWG.

Available for lease only.

### Features:

- Crimps up to 3600 pieces per hour
- Cycle Index holds terminal secure during wire insertion
- Dies can be changed quickly to accommodate different barrel sizes
- Positive die alignment to assure proper installation
- Equipped with either foot pedal activation or automatic sensor operation
- Safety Guard must be in place to operate
- Quiet operation

### Specifications:

- Weight: 88 lbs.
- Dimensions: 10.4" Wide x 16.34" long x 15.16" high
- Power Supply: 115VAC, 50/60 Hz
- Operating Air Pressure: 75-90 PSI



### Y500B Stripper & Cutter

Lightweight stripper & cutter for quick easy wire processing. The unique stripping blades automatically adjust to the wire gauge and strips with a quick squeeze of the handles. Cutting blade is exposed by pushing the thumb notch forward, inserting the wire and squeezing the handle to cut.

- Wire Sizes: 20-12 AWG



### Y510B Stripper & Cutter

Designed for stripping small diameter wires in a single movement. It has precision ground blades which cut cleanly through the insulation. An adjustable wire stop is attached to enable repeated stripping to a consistent length.

- Wire Sizes: 20-12 AWG

SEE OUR PLIER TYPE CRIMPING TOOLS FOR ADDITIONAL HAND TOOLS FOR CUTTING AND STRIPPING.

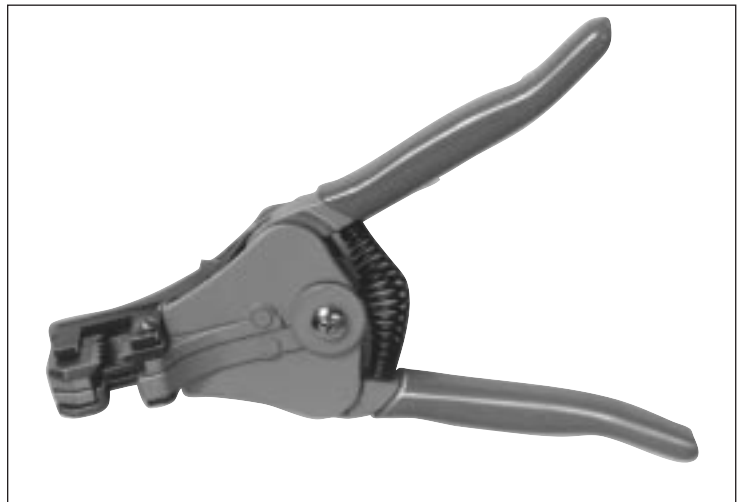

### Y130 Vinyl Pipe Cutter

Durable ratchet type hand tool for cutting rigid and flexible polyvinyl chloride (PVC) pipes and other pipes constructed of synthetic resins. Cutter blade is replaceable.



**HOFFMAN PRODUCTS**

hoffmanproducts.com • 1-800-645-2014

## YWC100 Wire Cutter



### Features:

- Portable bench top unit.
- Quick, efficient, cost effective programmable process to measure and cut to length electric wire, coaxial, phone cable and tubing.
- Speed: 1320 pieces/hour (6" lengths)
- Sizes: 8-28 (to .145 diameter), 10-28 (to .200 diameter),
- Coaxial, phone cable and tubing to 3/8" diameter
- Lengths are programmable in inches and centimeters
- Dimensions: 5.5 x 6.0 x 7.75
- Weight: 19 lbs.
- Cutting method: swing arm blade



## YHN2210K3 Crimp Tool Kit

Designed to crimp a wide variety of terminal barrel styles. This heavy duty ratchet crimping tool has a smooth easy ratchet mechanism. It comes with 4 different dies to crimp non-insulated, insulated, ferrules, and open barrel terminals and connectors. Dies are easily inserted or changed with 2 Phillips head screws. It comes in a lightweight, durable plastic carrying case.



## AK Kits

Terminal Crimping kits with plier tool # 401

## A24K4

A Professional maintenance engineer's kit containing 3000 pieces of the most popular insulated terminals and connectors. Heavy duty gray metal box with handle and clasp with 24 compartments for quick easy selection.

- Dimensions: 18 1/2" x 12" x 3"



## A21K4

Industrial maintenance shop kit. Containing 500 pieces of the most popular insulated terminals and connectors. A heavy-duty gray metal box with handle and clasp and 21 compartments.

- Dimensions: 13 x 9 1/4 x 2



# NUMERICAL INDEX

Refer to the Numerical Index below to choose the crimping tool you have selected. Go to the corresponding page for detailed information.

PART NO.	PAGE	PART NO.	PAGE
111	11	YFE2212	10
115	11	YG1210	10
603	13	YG1614	8
604	12	YG2216	8
607	13	YG8S	8
608	12	YHF200	8
609	13	YHM228	7
610	14	YHM61	7
611T	14	YHM88	7
A21K4	20	YHN2210K3	20
A24K4	20	YHT14S	7
AC5N	17	YHT2210	7
ACS300	17	YHT2622	7
AK38	11	YNG2214	10
AK60	11	YNM112	9
APF6	18	YNM123	9
FG6100	6	YNM126	9
PF2010	6	YNM2210	9
T640	11	YNM2210D	9
Y130	19	YNT1210S	9
Y401	6	YNT1614	9
Y500B	19	YNT2216	9
Y510B	19	YNT2622	9
Y801	6	YOM2210	8
YA1	15	YS2210	10
YA2	15	YS2210S	10
YA4	16	YS2216	10
YA5	16	YS7	10
YDT1210S	8	YS8S	10
YDT1614	8	YWC100	20
YDT2216	8		
YFE106	10		

