



SF1188C

465.00 MHz SAW Filter

- RF Filter for Family Radio Service Applications
- Low Insertion Loss
- 5.0 x 5.0 x 1.7 mm Surface-mount Case
- No Matching Required
- Complies with Directive 2002/95/EC (RoHS)



Absolute Maximum Ratings

Rating	Value	Units
Maximum Incident Power in Passband	+10	dBm
Maximum DC Voltage on any Non-ground Terminal	30	VDC
Storage Temperature Range in Tape and Reel	-40 to +85	°C
Suitable for Lead-free Soldering - Maximum Soldering Profile	260 °C for 30 s	

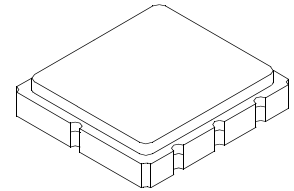

SM5050-8

Electrical Characteristics

Characteristic	Sym	Notes	Min	Typ	Max	Units
Center Frequency	f_C	1	465.000			MHz
Passband:						
Insertion Loss, $f_C \pm 2.0$ MHz	IL			2.0	4.0	dB
Amplitude Ripple, $f_C \pm 2.0$ MHz				1.0	2.0	dB _{P-P}
Rejection Referenced to 0 dB:		1, 2				dB
($f_C - 100$ MHz) to ($f_C - 45$ MHz)			50			
($f_C + 45$ MHz) to ($f_C + 100$ MHz)			50			
Operating Temperature Range	T_A	1	-10		+50	°C

Differential Input / Output Impedance Match	No External L-C required for 50Ω match
Case Style	SM5050-8 5 X 5 mm Nominal Footprint
Lid Symbolization (Y=year, WW=week S=shift)	452 YWWS

Electrical Connections

Connection	Terminals
Input	2
Output	6
Case Ground	All others

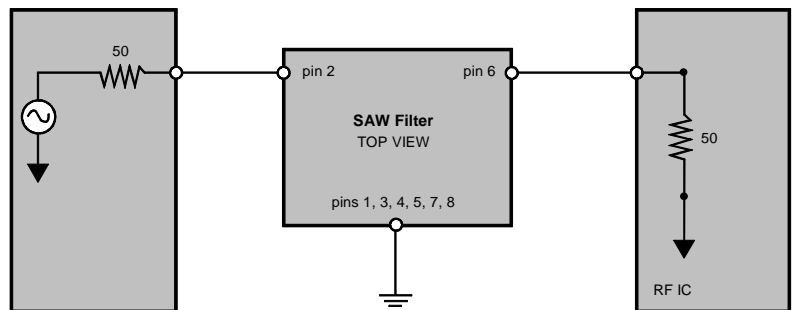

CAUTION: Electrostatic Sensitive Device. Observe precautions for handling.

Notes:

1. Unless noted otherwise, all specifications apply over the operating temperature range with filter soldered to the specified demonstration board with impedance matching to 50 Ω and measured with 50 Ω network analyzer.
2. Rejection is measured as attenuation below the minimum IL point in the passband. Rejection in final user application is dependent on PCB layout and external impedance matching design. See Application Note No. 42 for details.
3. The design, manufacturing process, and specifications of this filter are subject to change.
4. US and international patents may apply.
5. RFM, stylized RFM logo, and RF Monolithics, Inc. are registered trademarks of RF Monolithics, Inc.

Response

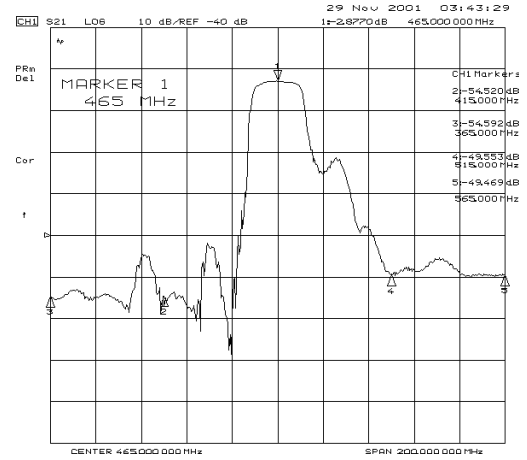
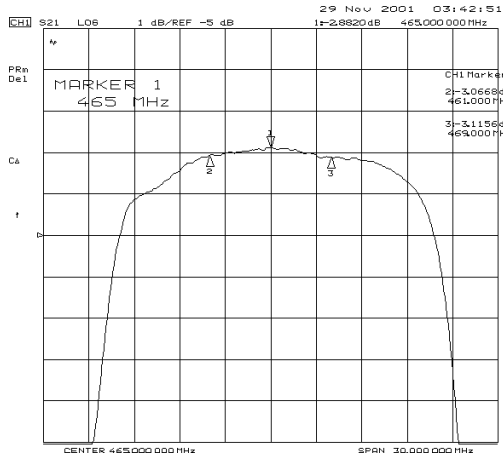

VSWR

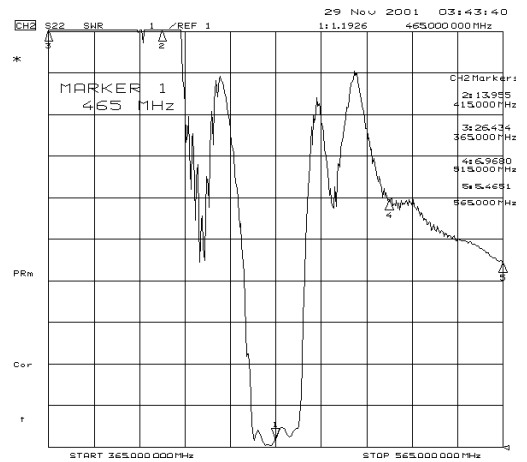
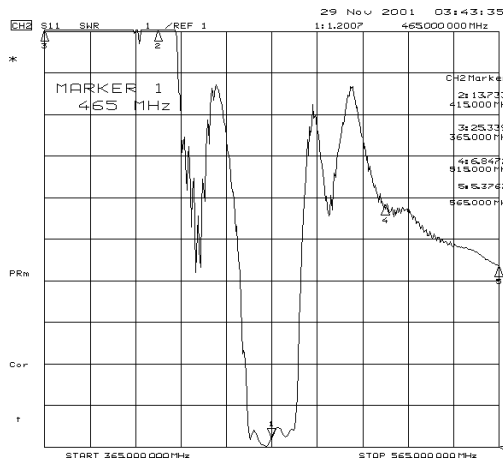

Smith Chart

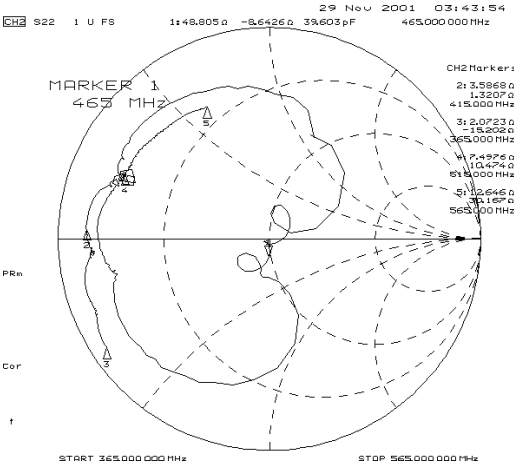
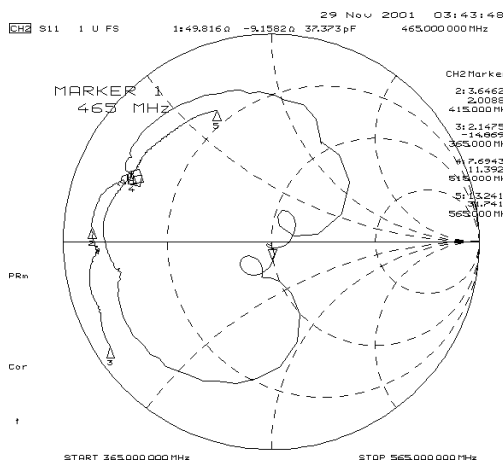

SM5050-8 Surface-Mount 8-Terminal Ceramic Case 5.0 X 5.0 mm Nominal Footprint

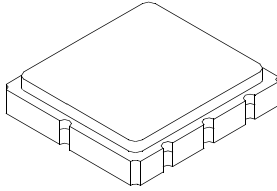

Case Dimensions

Dimension	mm			Inches		
	Min	Nom	Max	Min	Nom	Max
A	4.80	5.00	5.20	0.189	0.197	0.205
B	4.80	5.00	5.20	0.189	0.197	0.205
C	1.30	1.50	1.70	0.050	0.060	0.067
D	1.98	2.08	2.18	0.078	0.082	0.086
E	1.07	1.17	1.27	0.042	0.046	0.050
F	0.50	0.64	0.70	0.020	0.025	0.028
G	2.39	2.54	2.69	0.094	0.100	0.106
H		1.27			0.050	
I		0.76			0.030	
J		1.55			0.061	
K		2.79			0.110	
L		0.76			0.030	
M		2.36			0.093	
N		1.55			0.061	
O		2.79			0.110	
P		2.79			0.110	
Q		2.79			0.110	

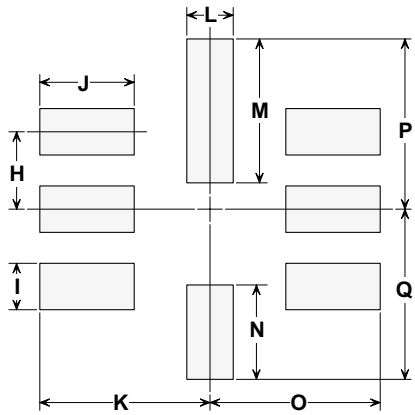

PCB Footprint

Case Materials

Materials	
Solder Pad Plating	0.3 to 1.0 μm Gold over 1.27 to 8.89 μm Nickel
Lid Plating	2.0 to 3.0 μm Nickel
Body	Al_2O_3 Ceramic
	Pb Free

TOP VIEW

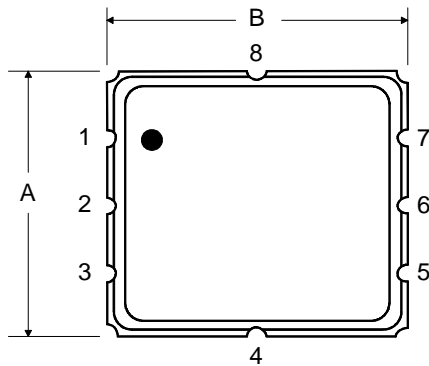

BOTTOM VIEW

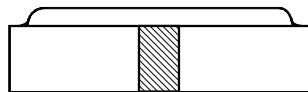
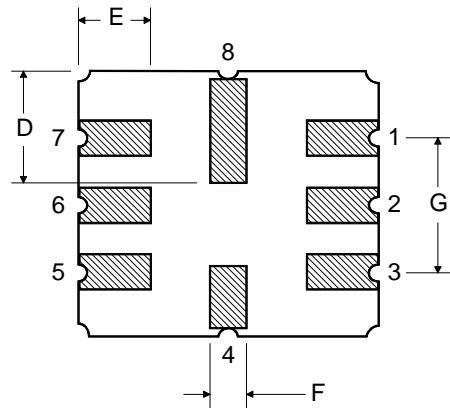

Tape and Reel Specifications

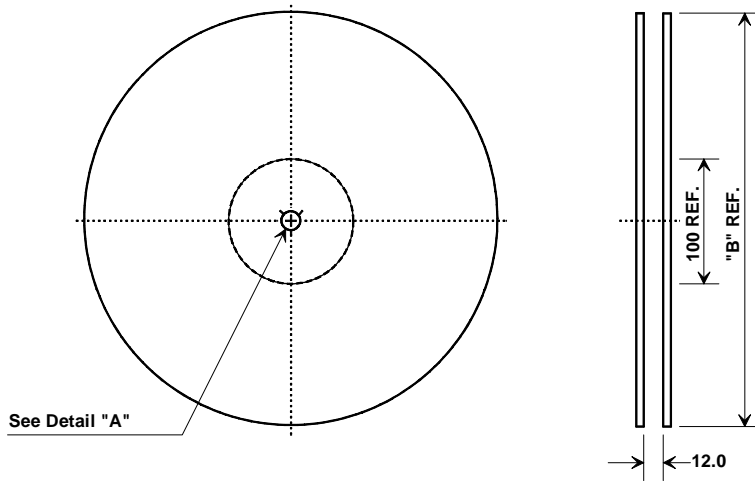

"B" Nominal Size		Quantity Per Reel
Inches	millimeters	
7	178	500
13	330	3000

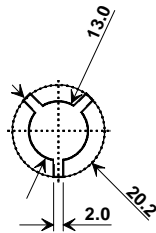

COMPONENT ORIENTATION and DIMENSIONS

Carrier Tape Dimensions	
Ao	5.3 mm
Bo	5.3 mm
Ko	2.0 mm
Pitch	8.0 mm
W	12.0 mm

