



- **Designed for 902.0 - 928.0 MHz Applications**
- **Optimized for use with the TRC103 Transceiver**
- **Balanced 150 ohm IC Interface**
- **Complies with Directive 2002/95/EC (RoHS)** 

RF2040E

**915.0 MHz
SAW Filter**

Absolute Maximum Ratings

Rating	Value	Units
Input Power Level	+15	dBm
DC Voltage	±5	V
Operating Temperature Range	-40 to +85	°C
Storage Temperature Range in Tape and Reel	-40 to +85	°C

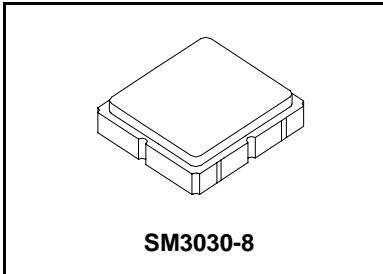

Electrical Characteristics

Characteristic	Sym	Notes	Min	Typ	Max	Units
Center Frequency	f_c			915.0		MHz
1 dB Bandwidth	BW_1			31		MHz
Maximum Insertion Loss, 902.0 to 928.0 MHz	IL_{MAX}			2.0	3.0	dB
Amplitude Ripple, p-p, 902.0 to 928.0 MHz				0.7	1.0	
Rejection Referenced to Insertion Loss at 915.0 MHz:						
710 to 810 MHz			37	40		
810 to 860 MHz			37	40		
1010 to 1060 MHz			37	40		
1060 to 1110 MHz			43	45		
1110 to 1210 MHz			45	48		
Source Impedance	Z_S			50		Ω
Load Impedance	Z_L			130		Ω

Case Style	SM3030-8 3.0 x 3.0 mm Nominal Footprint		
Lid Symbolization (Y=year, WW=week, S=shift) dot=pin 1 indicator	804, YWWS		
Standard Reel Quantity	Reel Size 7 Inch	1000 Pieces/Reel	
	Reel Size 13 Inch	3000 Pieces/Reel	

Electrical Connections

Connection	Terminals
Single-ended Port	6
Balanced Port	1, 3
Case Ground	4, 5, 7, 8
No Connection	2



CAUTION: Electrostatic Sensitive Device. Observe precautions for handling.

Notes:

1. Unless noted otherwise, all specifications apply over the operating temperature range with filter soldered to the specified demonstration board with impedance matching to 50 Ω and measured with 50 Ω network analyzer.
2. Unless noted otherwise, all frequency specifications are referenced to the nominal center frequency, f_c .
3. Rejection is measured as attenuation below the minimum IL point in the passband. Rejection in final user application is dependent on PCB layout and external impedance matching design. See Application Note No. 42 for details.
4. The design, manufacturing process, and specifications of this filter are subject to change.
5. US and international patents may apply.
6. RFM, stylized RFM logo, and RF Monolithics, Inc. are registered trademarks of RF Monolithics, Inc.

RF2040E-TRC103 Application Circuit

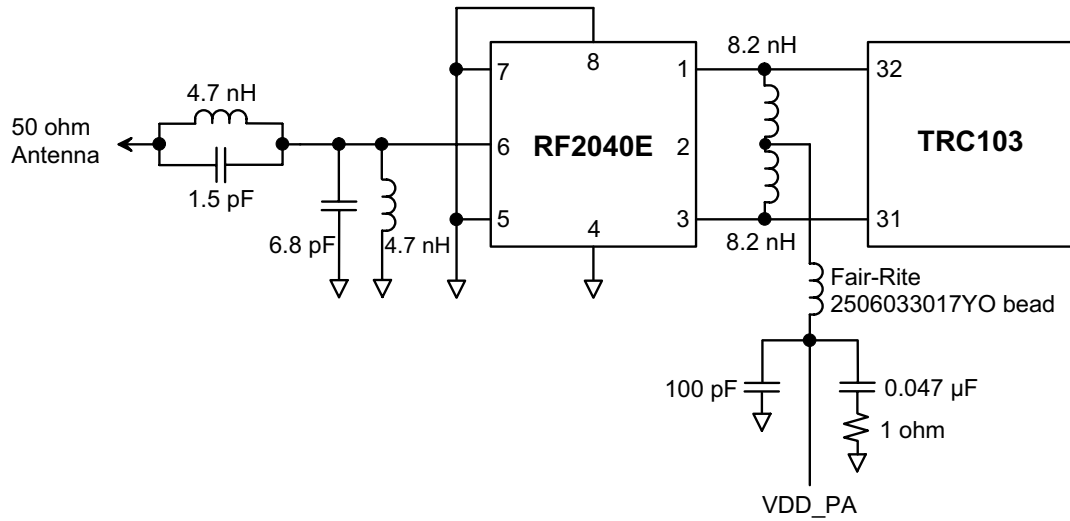

RF2040E 50 Ohm Tuning Network

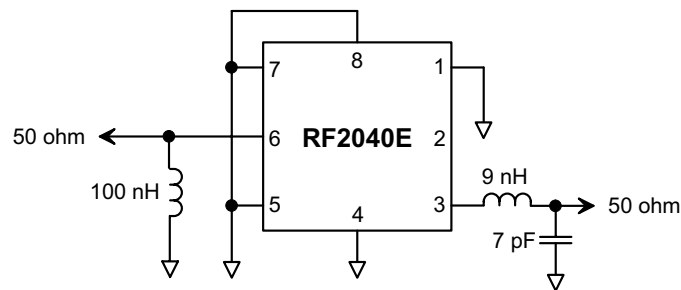

RF2040E Broadband Response, 200 to 2000 MHz

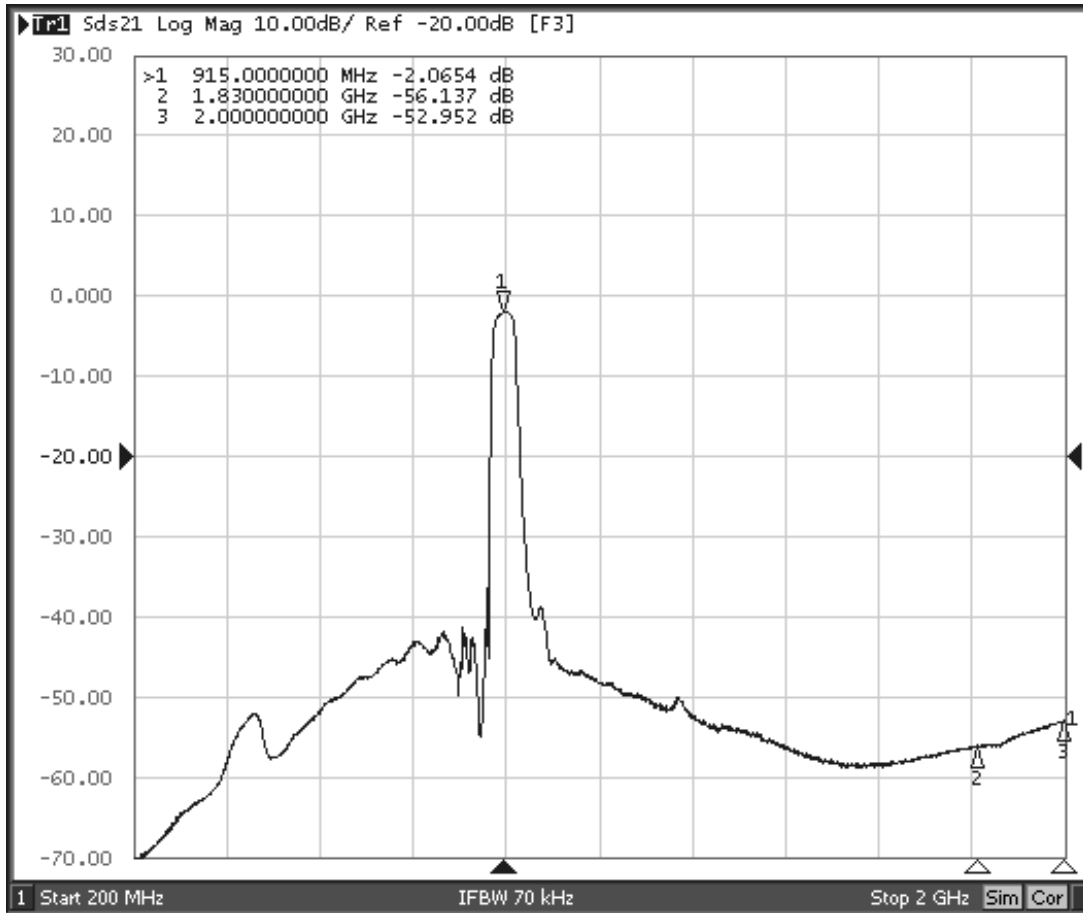

RF2040E Response, 815.0 to 1015.0 MHz

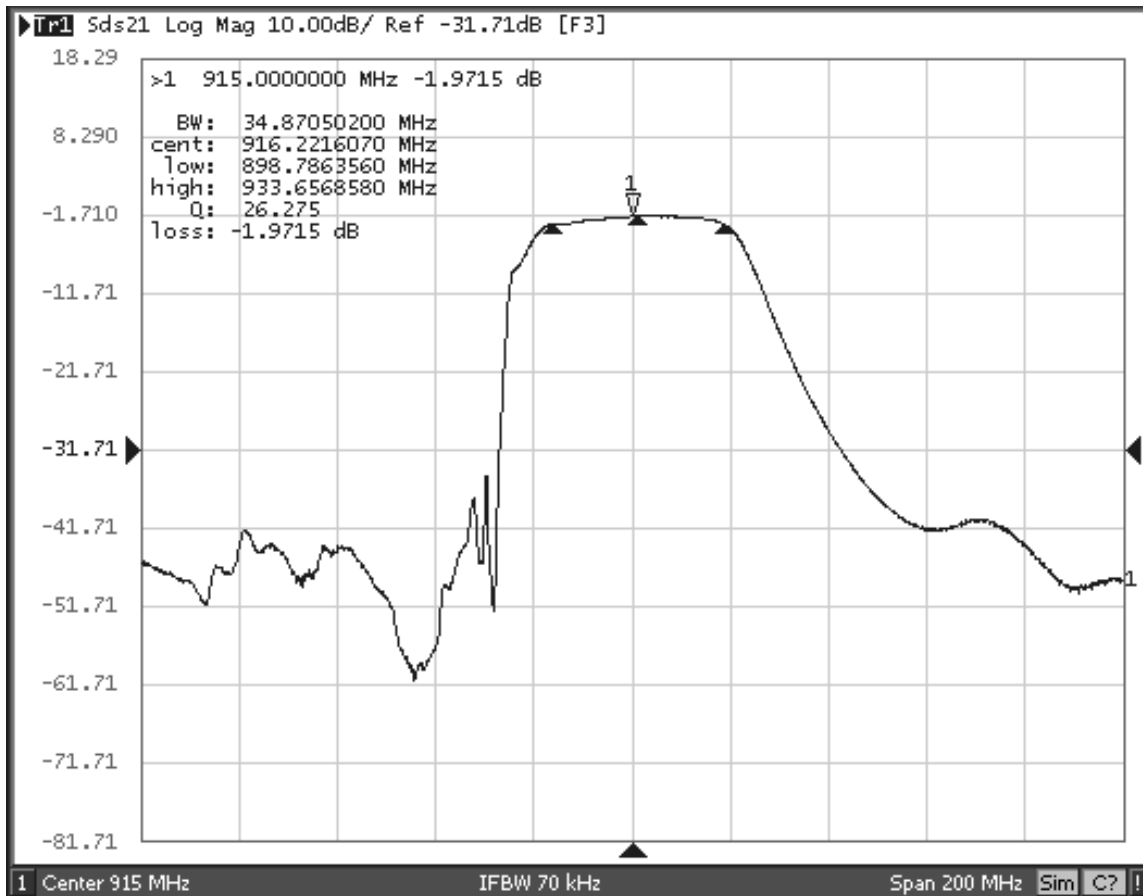

RF2040E Response, 865.0 to 965.0 MHz

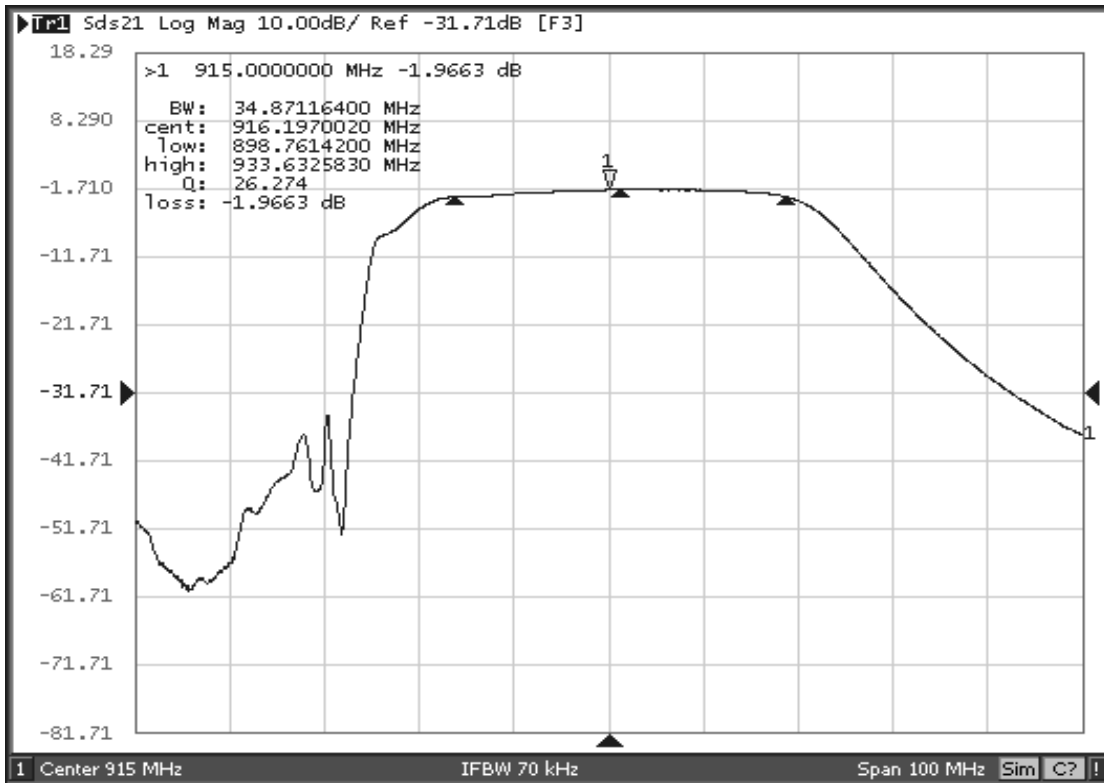

RF2040E Passband Response

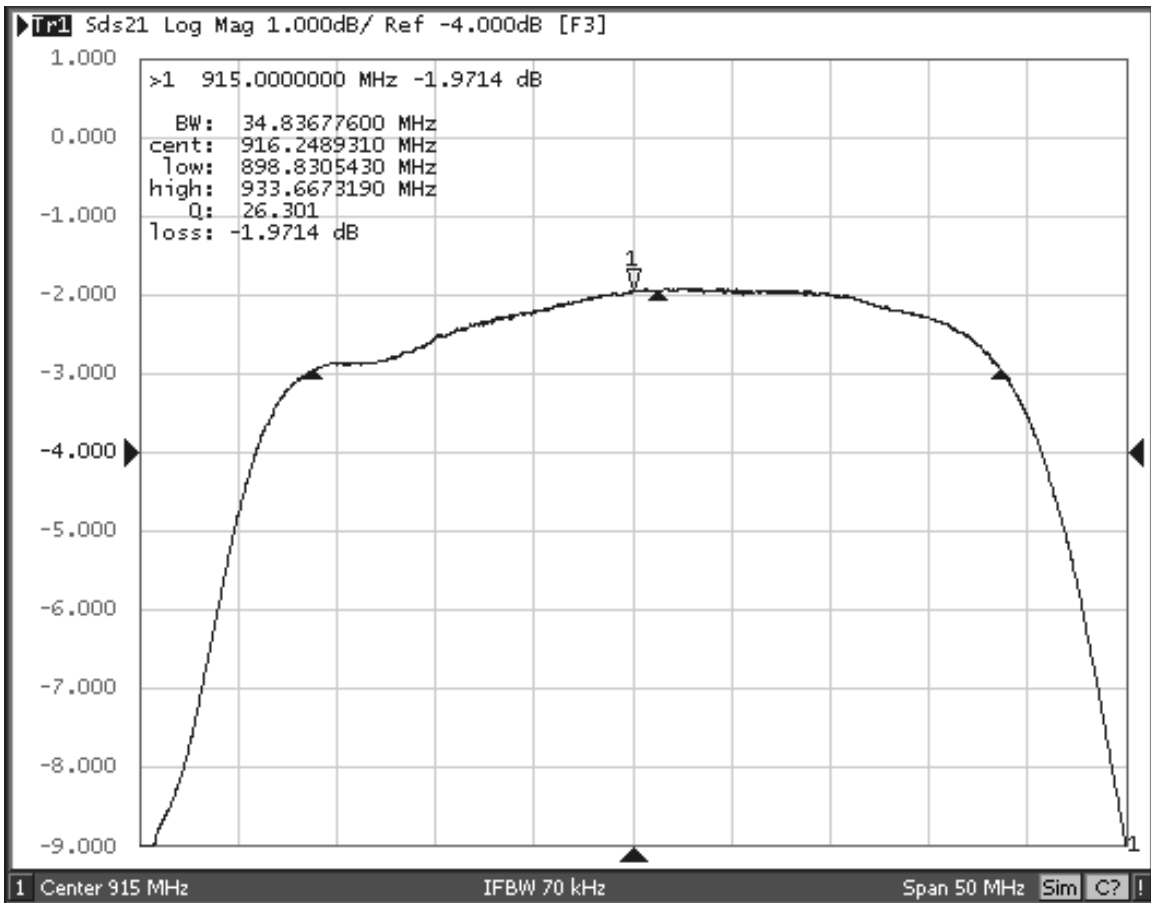

RF2040E Input Impedance Plot

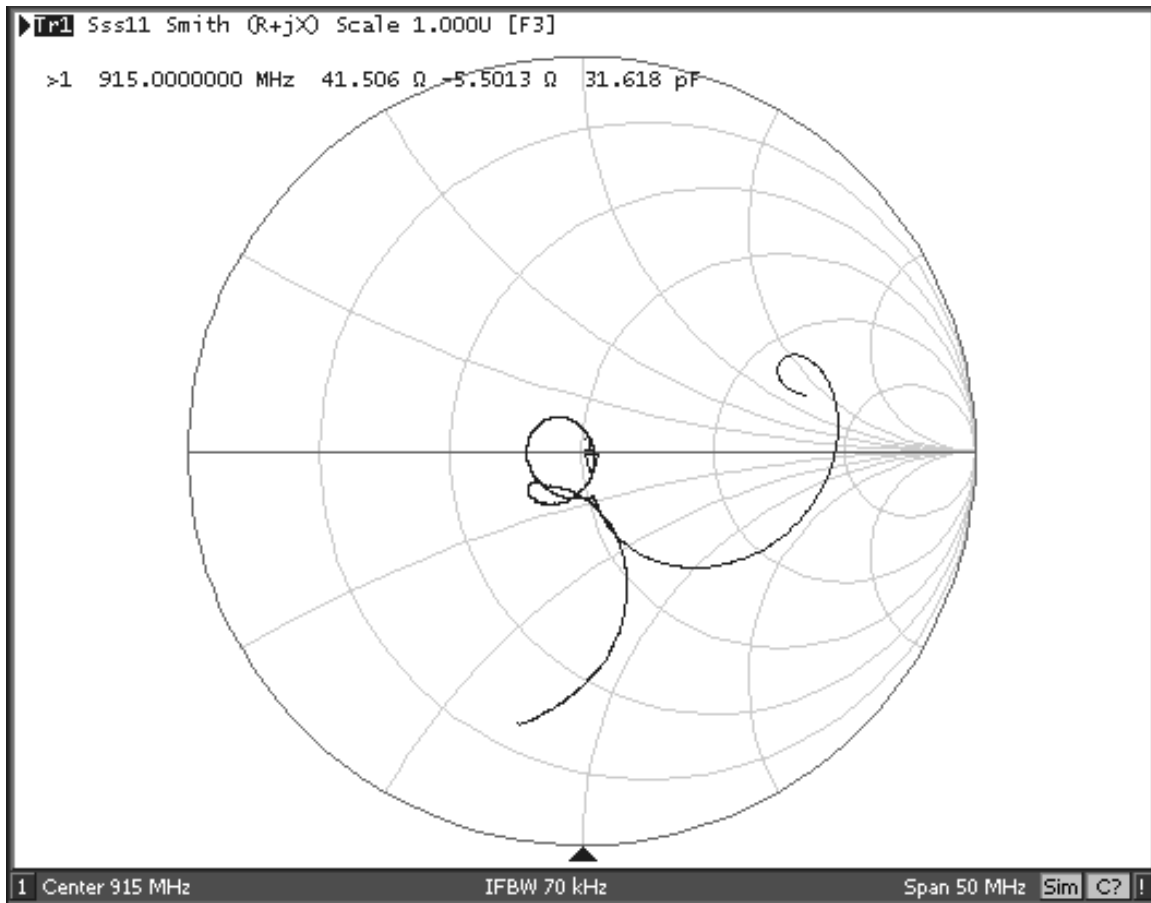

RF2040E Balanced Output Impedance Plot

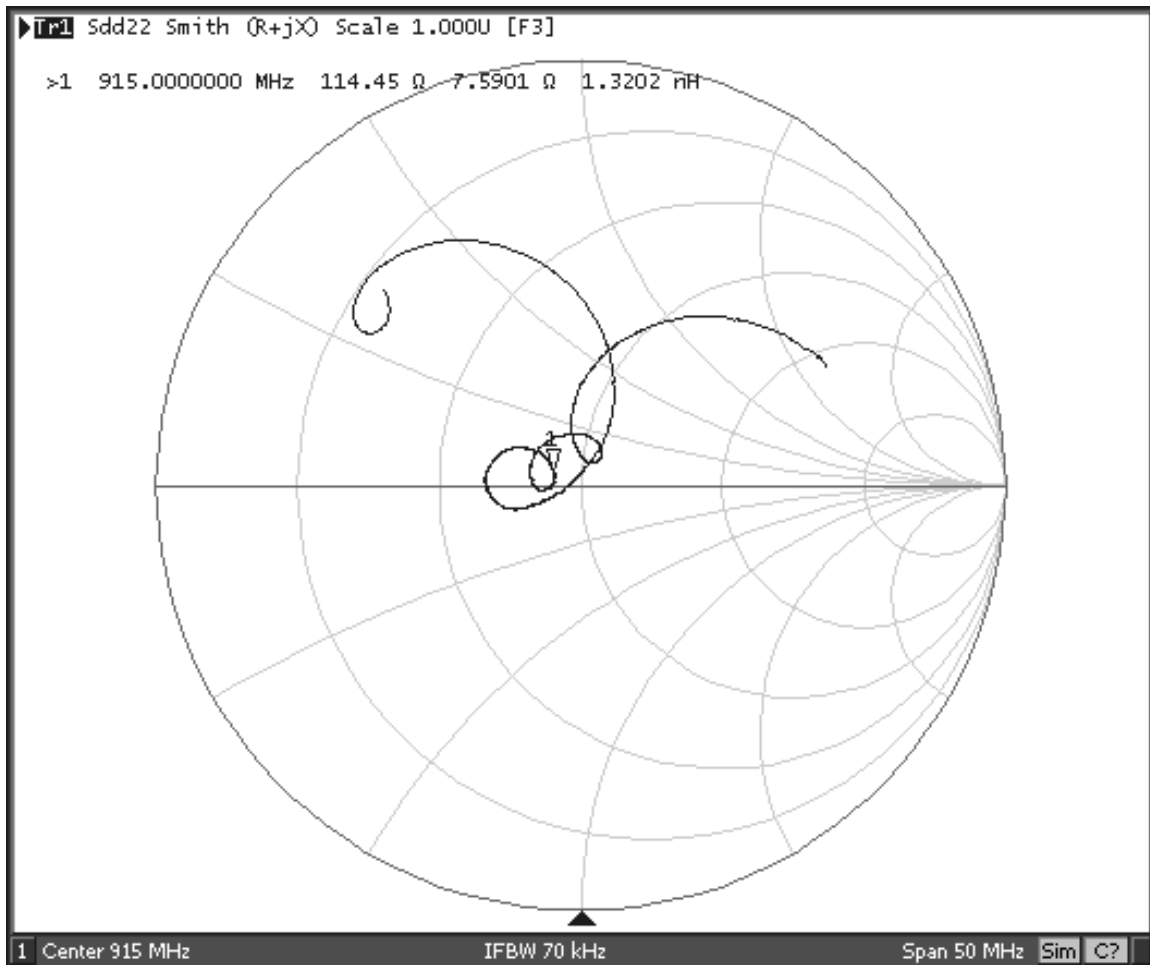

8-Terminal Ceramic Surface-Mount Case 3.0 X 3.0 mm Nominal Footprint

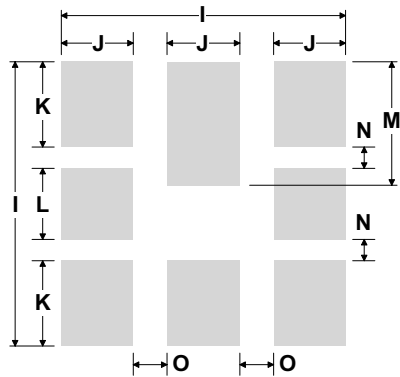
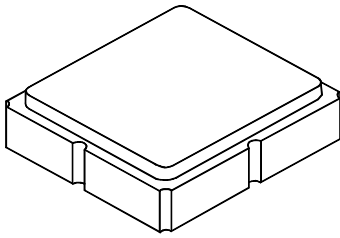

PCB Footprint Top View

Case and PCB Footprint Dimensions

Dimension	mm			Inches		
	Min	Nom	Max	Min	Nom	Max
A	2.87	3.0	3.13	0.113	0.118	0.123
B	2.87	3.0	3.13	0.113	0.118	0.123
C	1.14	1.27	1.40	0.045	0.050	0.055
D	0.79	0.92	1.05	0.031	0.036	0.041
E	0.62	0.75	0.88	0.024	0.029	0.034
F	0.47	0.60	0.73	0.018	0.024	0.029
G	0.47	0.60	0.73	0.018	0.024	0.029
H	1.07	1.20	1.33	0.042	0.047	0.052
I		3.19			0.126	
J		0.81			0.032	
K		0.96			0.038	
L		0.81			0.032	
M		1.39			0.055	
N		0.23			0.009	
O		0.38			0.015	

Case Materials

Materials	
Solder Pad Plating	0.3 to 1.0 μm Gold over 1.27 to 8.89 μm Nickel
Lid Plating	2.0 to 3.0 μm Nickel
Body	Al_2O_3 Ceramic
Pb Free	

TOP VIEW

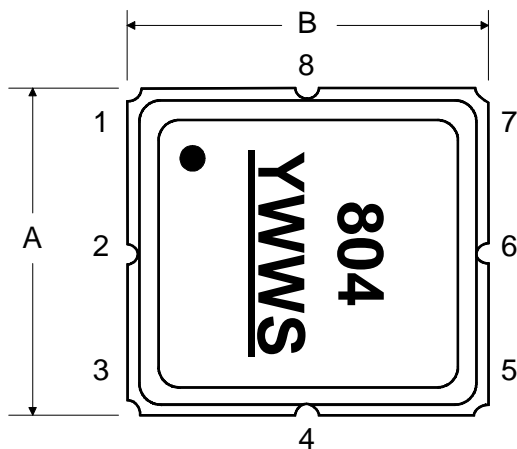

BOTTOM VIEW

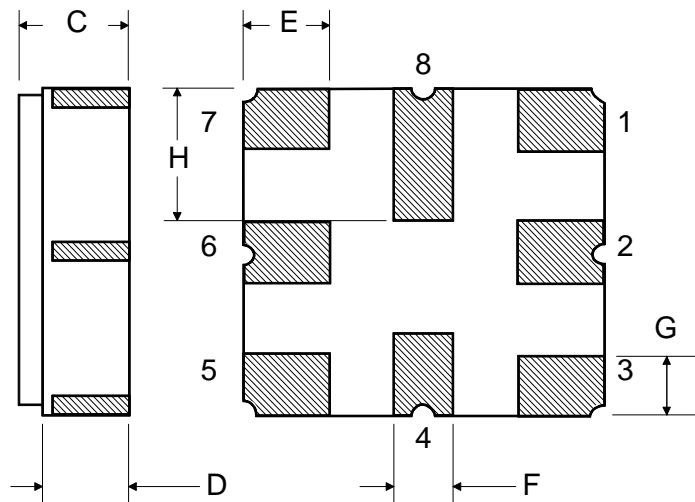

Tape and Reel Specifications

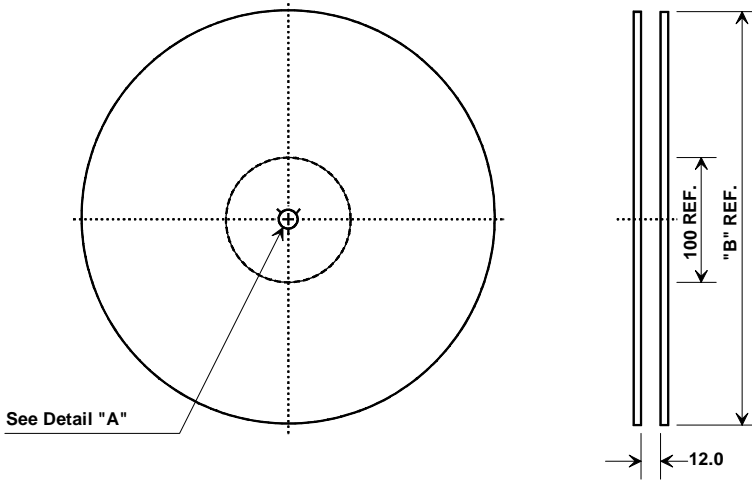

"B "		Quantity Per Reel
Inches	millimeters	
7	178	1000
13	330	3000

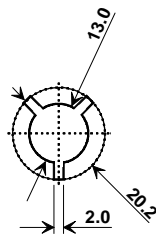

Carrier Tape Dimensions	
Ao	3.35 mm
Bo	3.35 mm
Ko	1.4 mm
Pitch	8.0 mm
W	12.0 mm

COMPONENT ORIENTATION and DIMENSIONS

