



AN3014 Application note

19 V, 90 W resonant converter with synchronous rectification
using the L6563H, L6599A and SRK2000

Introduction

This application note describes the characteristics and the features of a 90 W demonstration board (EVL90WADP-LLCSR), tailored to specifications for a typical high-end portable computer power supply. A peculiarity of this SMPS design is the very high efficiency compliant with ENERGY STAR[®] eligibility criteria (EPA rev. 2.0 EPS). One of the key factors in achieving this result is the SRK2000. This synchronous rectification driver for LLC resonant converters allows significantly reduced secondary-side losses. Thanks to this improvement, secondary-side heatsinks, which are typically needed for this power range, can be dramatically reduced or even removed.

Figure 1. EVL90WADP-LLCSR: 90 W adapter demonstration board

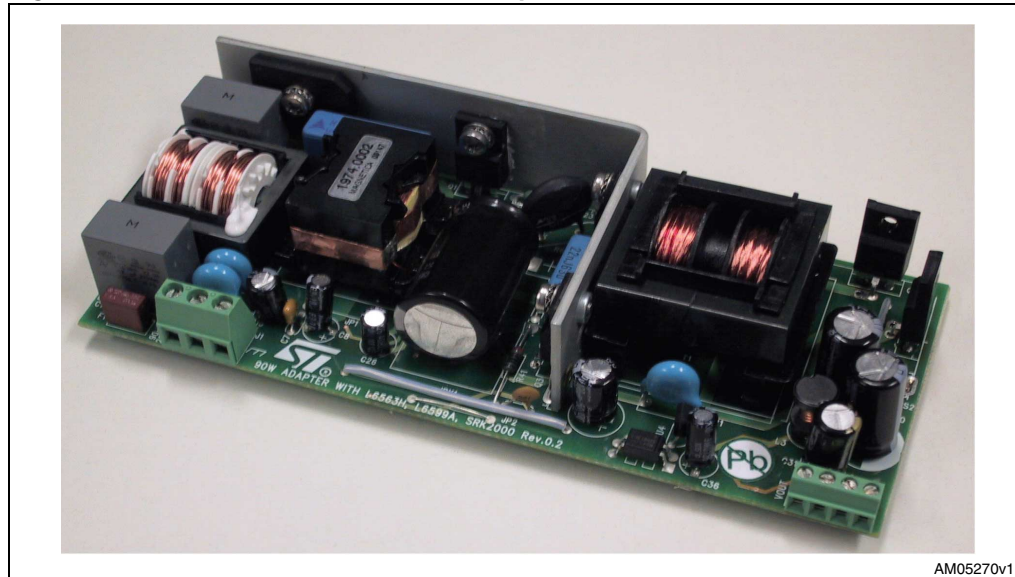

Contents

1	Main characteristics and circuit description	5
2	Efficiency measurement	10
3	Harmonic content measurement	12
4	Functional check	13
5	Thermal map	17
6	Conducted emission pre-compliance test	18
7	Bill of material	19
8	PFC coil specification	24
9	Transformer specification	26
10	Revision history	28

List of tables

Table 1.	Overall efficiency	10
Table 2.	Efficiency comparison	10
Table 3.	Light load efficiency	11
Table 4.	Thermal map reference points	17
Table 5.	EVL90WADP-LLCSR demonstration board bill of material	19
Table 6.	PFC coil winding data	24
Table 7.	Transformer winding data	26
Table 8.	Document revision history	28

List of figures

Figure 1.	EVL90WADP-LLCSR: 90 W adapter demonstration board	1
Figure 2.	Electrical diagram	9
Figure 3.	Light load efficiency diagram	11
Figure 4.	Compliance to EN61000-3-2 at 230 Vac - 50 Hz, full load	12
Figure 5.	Compliance to JEITA-MITI at 100 Vac - 50 Hz, full load.	12
Figure 6.	Resonant stage oscillator at 230 V - 50 Hz - full load.	13
Figure 7.	Resonant stage waveforms at 230 V - 50 Hz - full load	13
Figure 8.	Secondary waveforms at 230 V - 50 Hz	14
Figure 9.	Startup sequencing at 230 V - 50 Hz	14
Figure 10.	No load operation at 230 V - 50 Hz	14
Figure 11.	No load operation - detail at 230 V - 50 Hz.	14
Figure 12.	Transition full load to no load at 265 Vac - 50 Hz.	15
Figure 13.	Transition no load to full load at 265 Vac - 50 Hz.	15
Figure 14.	Short-circuit at full load and 115 Vac - 60 Hz	16
Figure 15.	Short-circuit detail at full load and 115 Vac - 60 Hz	16
Figure 16.	Thermal map at 115 Vac - 60 Hz - full load	17
Figure 17.	Thermal map at 230 Vac - 50 Hz - full load	17
Figure 18.	CE average measurement at 115 Vac and full load	18
Figure 19.	CE average measurement at 230 Vac and full load	18
Figure 20.	PFC coil electrical	24
Figure 21.	PFC coil mechanical aspect	25
Figure 22.	Transformer electrical diagram	26
Figure 23.	Transformer overall drawing	27

1 Main characteristics and circuit description

The main features of the SMPS are:

- Universal input mains range: 90 – 264 Vac, frequency 45 – 65 Hz
- Output voltage: 19 V at 4.75 A continuous operation
- Mains harmonics: according to EN61000-3-2 class-D or JEITA-MITI class-D
- Standby mains consumption: < 0.26 W at 230 Vac
- Efficiency at nominal load: > 92% at 115 Vac
- EMI: according to EN55022-class-B
- Safety: according to EN60950
- Dimensions: 65 x 155 mm, 25 mm maximum component height
- PCB: double-sided, 70 µm, FR-4, mixed PTH/SMT

The circuit is composed of two stages: a front-end PFC using the L6563H, and a LLC resonant converter based on the L6599A. The SRK2000 controls the synchronous rectification on the secondary side. The PFC stage works as a preregulator and powers the resonant stage with a constant voltage of 400 V. The downstream converter operates only if the PFC is on and regulating. In this way, the resonant stage can be optimized for a narrow input voltage range.

Startup sequence

As indicated previously, the PFC acts as master and the resonant stage can operate only if the PFC output is delivering the nominal output voltage. Therefore the circuit is designed so that at startup the PFC starts first, then the downstream converter turns on. Initially, the L6563H is supplied by the integrated high voltage startup circuit, but as soon as the PFC starts switching, a charge pump connected to the PFC inductor supplies both the PFC and resonant controllers. Once both stages have been activated, the controllers are supplied also by the auxiliary winding of the resonant transformer, assuring correct supply voltage even during standby operation.

Because the L6563H integrated HV startup circuit is turned off and therefore is not dissipative during normal operation, it significantly contributes to the reduction of power consumption when the power supply operates at light load, in accordance with current world-wide standby consumption standards.

Brownout protection

Brownout protection prevents the circuit from working with abnormal mains levels. It is easily achieved using the RUN pin (pin12) of the L6563H. This pin is connected through a resistor divider to the VFF pin (pin 5), which provides the mains voltage peak value information. An internal comparator enables the IC operations if the mains level is correct, within the nominal limits. At startup, if the input voltage is below 90 Vac (typ), circuit operations are inhibited.

The L6599A has similar protection on the LINE pin (pin 7). It is used to prevent the resonant converter from working with too low an input voltage, which can cause incorrect capacitive mode operation. If the bulk voltage (PFC output) is below 380 V, the resonant startup is not allowed. The L6599A internal comparator has a hysteresis which allows the turn-on and turn-off voltage to be set independently. The turn-off threshold has been set to 300 V in

order to avoid capacitive mode operation, but to allow the resonant stage to operate even in case of mains sag and consequent PFC output dip.

Fast voltage feed-forward

The voltage on the L6563H VFF pin (pin 5) is the peak value of the voltage on the MULT pin (pin 3). The RC network (R15+R26, C12) connected to VFF completes the peak-holding circuit. This signal is necessary to derive RMS input voltage information to compensate the loop gain, which is mains voltage dependent.

Generally speaking, if the time constant is too small, the voltage generated is affected by a considerable amount of ripple at twice the mains frequency, thus causing distortion of the current reference (resulting in high THD and poor PF). If the time constant is too large, there is a considerable delay in setting the right amount of feed-forward, resulting in excessive overshoot or undershoot of the preregulator's output voltage in response to large line voltage changes.

To overcome this issue, the L6563H implements the new fast voltage feed-forward function. As soon as the voltage on the VFF pin decreases to a set threshold (40 mV typically), a mains dip is assumed and an internal switch rapidly discharges the VFF capacitor via a 10-k Ω resistor. Thanks to this feature, it is possible to set an RC circuit with a long time constant, assuring a low THD and maintaining a fast response to mains dip.

Resonant power stage

The downstream converter employs ST's L6599A, which incorporates all the functions necessary to properly control the resonant converter with a 50% fixed duty cycle and works with a variable frequency.

The transformer uses the integrated magnetic approach, incorporating a resonant series inductor. Thus, no additional external coil is needed for the resonance. The transformer configuration chosen for the secondary winding is center tap.

On the secondary side, the output rectification is controlled by the SRK2000, an SR driver dedicated to LLC resonant topology.

A small LC filter has been added on the output, filtering the high-frequency ripple.

D15, R56, R62, R65, R66, Q5 and Q6 implement an output voltage "fast discharge" circuit which quickly discharges the output capacitors when the converter is turned off. It has been implemented to quickly decrease the residual output voltage after the converter is turned off at no load.

Output voltage feedback loop

The feedback loop is implemented by means of a typical circuit using a TL431 to modulate the current in the optocoupler diode.

On the primary side, R34 - connecting the RFMIN pin (pin 4) to the optocoupler phototransistor - closes the feedback loop and its value sets the maximum switching frequency at about 130 kHz. This value has been chosen to limit the switching losses at light load operation. R31, which connects the same pin to ground, sets the minimum switching frequency. The R-C series (R44 and C18) sets both the soft-start maximum frequency and duration.

L6599A overload and short-circuit protection

The current into the primary winding is sensed by the lossless circuit R41, C27, D11, D10, R39, and C25 and is fed to the ISEN pin (pin 6). In case of overcurrent, the voltage on the pin passes an internal threshold (0.8 V), triggering a protection sequence. The capacitor (C45) connected to the DELAY pin (pin 2) is charged by an internal 150- μ A current generator and is slowly discharged by the external resistor (R24). If the voltage on the pin reaches 2 V, the soft-start capacitor is completely discharged so that the switching frequency is pushed to its maximum value. As the voltage on the pin exceeds 3.5 V, the IC stops switching and the internal generator is turned off, so that the voltage on the pin decays due to the external resistor. The IC is soft-restarted as the voltage drops below 0.3 V. In this way, under short-circuit conditions, the converter works intermittently with very low input average power.

Overvoltage and open loop protection

Both the PFC and resonant circuit stages are equipped with their own overvoltage protection.

The PFC controller L6563H monitors its output voltage via the resistor divider connected to a dedicated pin (PFC_OK, pin 7), protecting the circuit in case of loop failures, disconnection or deviation from the nominal value of the feedback loop divider. If the voltage on pin #7 exceeds 2.5 V the IC stops switching and restarts as the voltage on the pin falls below 2.4 V, preventing the output voltage becoming excessive in case of transient due to the slow response of the error amplifier. However, if contemporaneously the voltage of the INV pin falls below 1.66 V (typ.), a feedback failure is assumed. In this case the PFC_OK circuitry latches the L6563H operations and, by means of the PWM_LATCH pin (pin 8) it latches the L6599A as well, via the DIS pin (pin 8). The converter is kept latched by the L6563H HV circuit which supplies the IC, charging the V_{CC} capacitor periodically. To resume converter operation, mains restart is necessary.

The DIS pin is used to protect also the resonant stage against overvoltage. The Zener diode D8 detects the auxiliary voltage, which is proportional to the output voltage. In case of loop failure it conducts and voltage on the DIS pin exceeds the internal threshold, and latches off the device. L6563H operation is also stopped by the PFC_STOP pin.

Secondary-side synchronous rectification with the SRK2000

The SRK2000 core function is to switch on each synchronous rectifier MOSFET whenever the corresponding transformer half-winding starts conducting (i.e. when the MOSFET body diode starts conducting), and then to switch it off when the current flowing through it approaches zero. For this purpose, the IC is equipped with two pins (DVS1 and DVS2) capable of sensing the MOSFET drain voltage level.

Standby power saving

The board has a burst-mode function implemented, allowing power saving during light load operation.

The L6599A STBY pin (pin 5) senses the optocoupler's collector voltage, which is related to the feedback control. This signal is compared to an internal reference (1.24 V). If the voltage on the pin is lower than the reference, the IC enters an idle state and its quiescent current is reduced. As the voltage exceeds the reference by 50 mV, the controller restarts the switching. The burst-mode operation load threshold can be programmed by properly choosing the resistor connecting the optocoupler to the RFMIN pin (R34). On this board, the controller operates in burst-mode if the load falls below ~ 10 W.

The L6563H implements its own burst-mode function. If the COMP voltage falls below 2.5 V, the IC stops switching, causing an output voltage drop. As a consequence, the COMP voltage rises again and the IC starts switching again.

In order to achieve better load transient response, the PFC burst-mode operation is partially forced by the resonant converter: as soon as the L6599A stops switching due to load drops, its PFC_STOP pin pulls down the L6563H's PFC_OK pin, disabling PFC switching. Thanks to this simple circuit, the PFC is forced into an idle state when the resonant stage is not switching, and rapidly wakes up when the downstream converter restarts switching. This solution prevents significant drop of the bulk voltage in case of abrupt load rising.

Figure 2. Electrical diagram

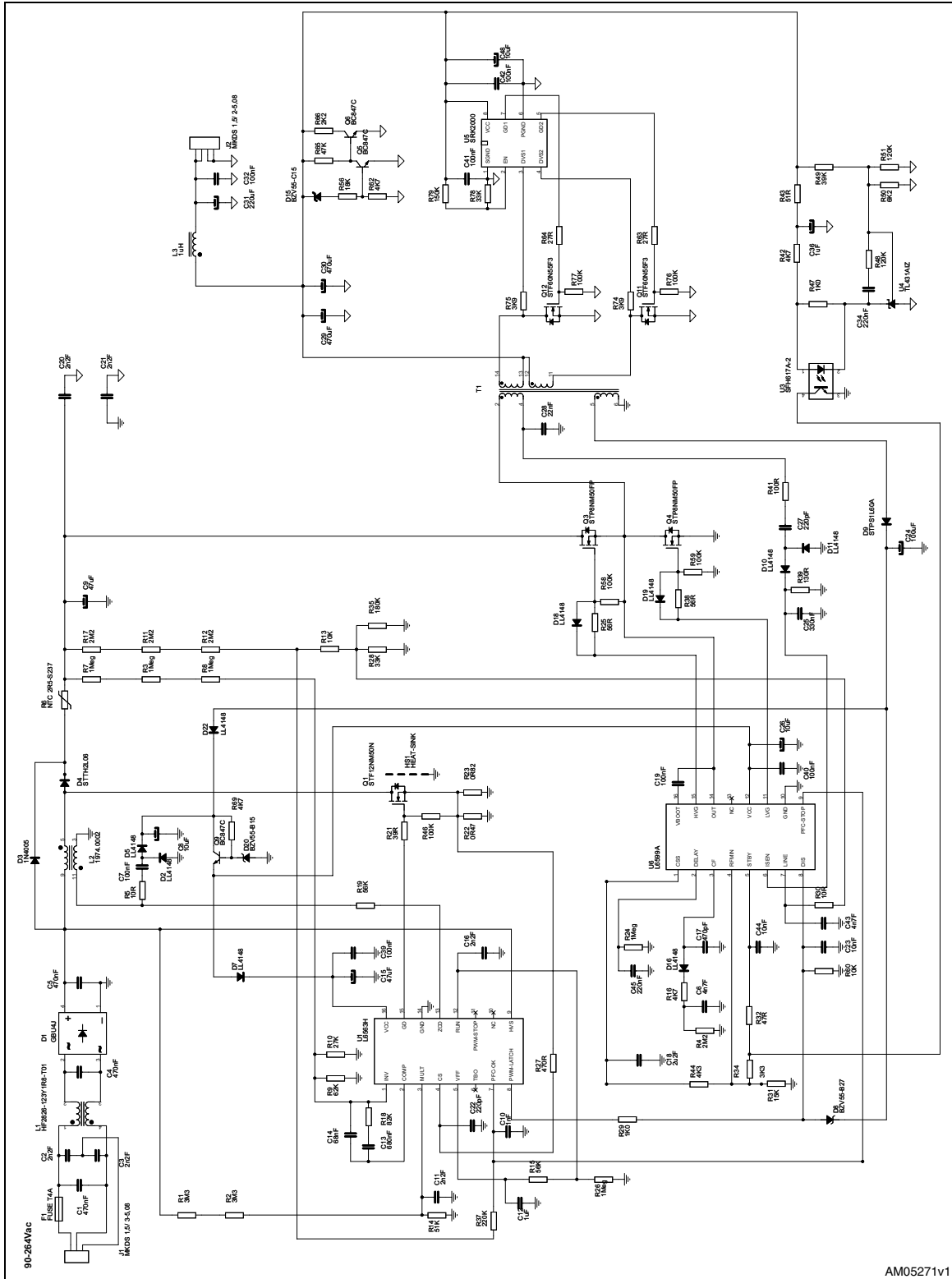

2 Efficiency measurement

EPA rev. 2.0 external power supply compliance verification

Table 1 shows the no-load consumption and overall efficiency, measured at the nominal mains voltages. At 115 Vac the average efficiency is 91.27%, while at 230 Vac it is 92.22%. Both values are much higher than the 87% required by the EPA rev 2.0 external power supply limits.

Even at no-load, the board performances are superior: maximum no-load consumption at nominal mains voltage is 260 mW only. This value is significantly lower than the limit imposed by the ENERGY STAR® program, which is 500 mW.

Table 1. Overall efficiency

Test	230 V-50 Hz					115 V-60 Hz				
	Vout [V]	Iout [mA]	Pout [W]	Pin [W]	Eff. [%]	Vout [V]	Iout [mA]	Pout [W]	Pin [W]	Eff. [%]
No load	18.98	0.00	0.00	0.26	-	18.98	0.00	0.00	0.23	-
25% load eff.	18.97	1187	22.52	25.46	88.45%	18.97	1187	22.51	25.41	88.57%
50% load eff.	18.95	2375	45.01	48.70	92.42%	18.95	2374	44.99	49.03	91.77%
75% load eff.	18.94	3565	67.52	71.96	93.82%	18.94	3565	67.50	73.06	92.38%
100% load eff.	18.92	4756	89.99	95.54	94.19%	18.92	4758	90.02	97.48	92.34%
Average eff.					92.22%					91.27%

Efficiency comparison between diode rectification and synchronous rectification

In *Table 2*, the efficiency of two different designs are compared. One is the EVL90WADP-LLCSR board, and the other is an identical board but with diode rectification (two STPS10L60 devices). In this way, a direct indication of the efficiency improvement obtained with the new synchronous rectification solution is obtained.

Table 2. Efficiency comparison

Test	230 V-50 Hz			115 V-60 Hz		
	Eff. with diodes	Eff. with SRK2000	Variation	Eff. with diodes	Eff. with SRK2000	Variation
25% load eff.	87.49%	88.45%	0.96%	88.24%	88.57%	0.33%
50% load eff.	91.52%	92.42%	0.90%	90.85%	91.77%	0.91%
75% load eff.	92.58%	93.82%	1.24%	91.16%	92.38%	1.23%
100% load eff.	92.84%	94.19%	1.35%	91.00%	92.34%	1.34%
Average eff.	91.11%	92.22%	1.11%	90.31%	91.27%	0.95%

Light load operation efficiency

Measurement results are reported in [Table 3](#) below and plotted in [Figure 3](#). As shown, efficiency is better than 68% even for very light loads, such as 1 W.

Table 3. Light load efficiency

Test	230 V - 50 Hz					115 V - 60 Hz				
	Vout [V]	Iout [mA]	Pout [W]	Pin [W]	Eff. [%]	Vout [V]	Iout [mA]	Pout [W]	Pin [W]	Eff. [%]
0.25 W	18.97	13.2	0.250	0.610	41.05%	18.97	13.2	0.250	0.590	42.45%
0.5 W	18.97	26.4	0.501	0.877	57.18%	18.97	26.4	0.501	0.870	57.57%
1.0 W	18.97	52.7	0.999	1.467	68.13%	18.97	52.7	0.999	1.457	68.60%
1.5 W	18.98	79.0	1.499	2.160	69.41%	18.97	79.2	1.503	2.134	70.41%
2.0 W	18.97	105.5	2.002	2.822	70.93%	18.97	105.5	2.002	2.895	69.15%
2.5 W	18.97	131.8	2.500	3.558	70.27%	18.98	131.8	2.501	3.711	67.38%
3.0 W	18.98	158.3	3.004	4.110	73.09%	18.97	158.3	3.002	4.230	70.97%
3.5 W	18.97	184.5	3.501	4.660	75.13%	18.97	184.5	3.501	4.637	75.49%
4.0 W	18.97	210.8	3.999	5.256	76.08%	18.97	210.8	3.999	5.234	76.40%
4.5 W	18.97	237.3	4.502	5.840	77.08%	18.97	237.3	4.502	5.830	77.22%
5.0 W	18.97	263.6	5.000	6.450	77.52%	18.97	263.6	5.001	6.420	77.89%

Figure 3. Light load efficiency diagram

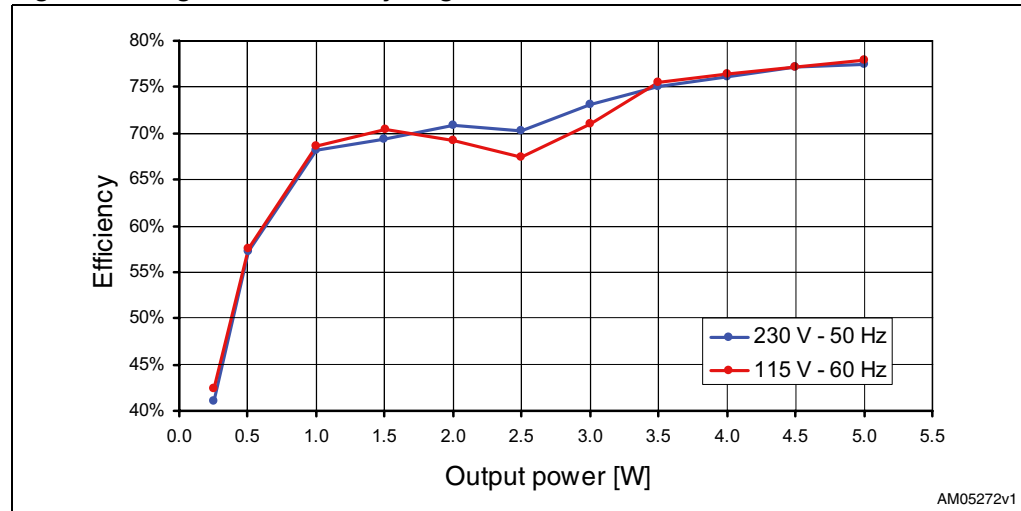

3 Harmonic content measurement

The board has been tested according to the European standard EN61000-3-2 class-D and Japanese standard JEITA-MITI Class-D, at both nominal input voltage mains. As reported in graphs that follow, the circuit is capable of reducing the harmonics well below the limits of both regulations.

Figure 4. Compliance to EN61000-3-2 at 230 Vac - 50 Hz, full load

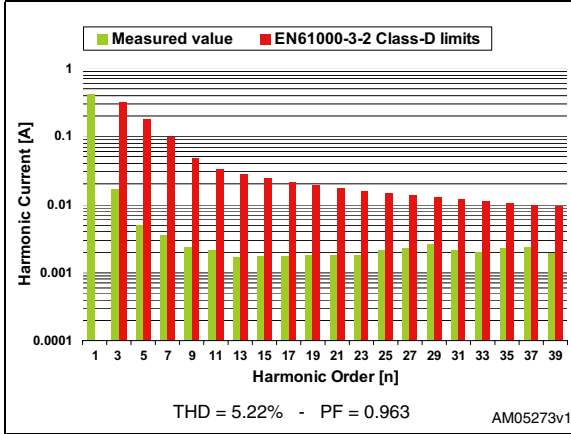
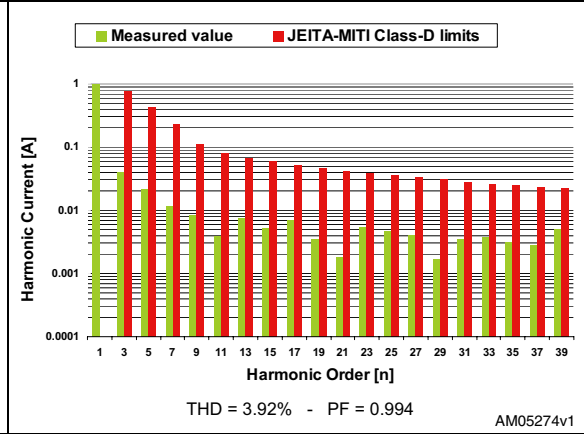

Figure 5. Compliance to JEITA-MITI at 100 Vac - 50 Hz, full load



At the bottom of the diagrams, the total harmonic distortion and power factor measurements are also reported. The values in all conditions provide a clear overview of the correct functionality of the PFC.

4 Functional check

Figure 6 and *Figure 7* are waveforms relevant to the resonant stage during steady state operation. The selected switching frequency is approximately 100 kHz in order to achieve a good trade-off between transformer losses and dimensions. The converter operates above the resonance frequency. *Figure 7* shows the resonant ZVS operation. Both MOSFETs are turned on when resonant current is flowing through their body diodes and the drain-source voltage is zero.

Figure 6. Resonant stage oscillator at 230 V - 50 Hz - full load

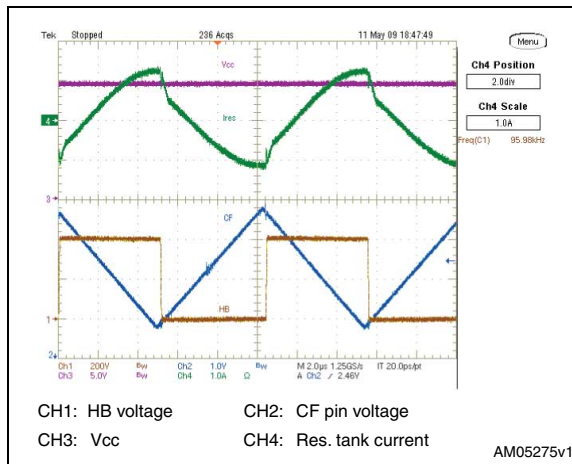
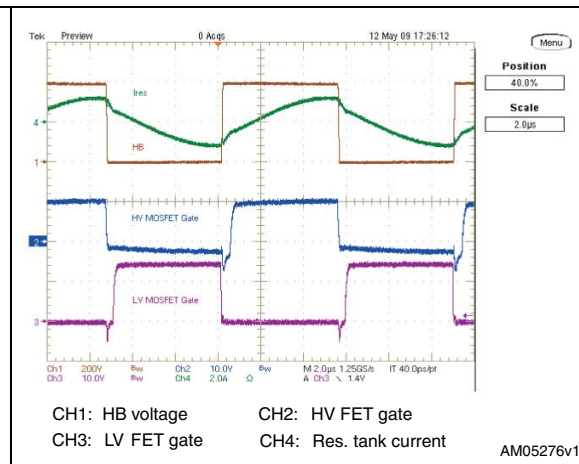

Figure 7. Resonant stage waveforms at 230 V - 50 Hz - full load



In *Figure 8*, typical waveforms relevant to the secondary side are shown. It can be noted that the rectifier MOSFETs are switched on and off according to the current flowing through them. *Figure 9* shows the waveforms during startup at 90 Vac and full load. Here, the sequence of the two stages can be noted: at power-on the L6563H and L6599A V_{CC} voltages increase up to the turn-on thresholds of the two ICs. The PFC starts and its output voltage increases from the mains rectified voltage to its nominal value. In the meantime, the L6599A is kept inactive by the LINE pin (pin 7) until the PFC voltage reaches the set threshold. Then the resonant starts operating and the output voltage reaches the nominal level.

Figure 8. Secondary waveforms at 230 V - 50 Hz

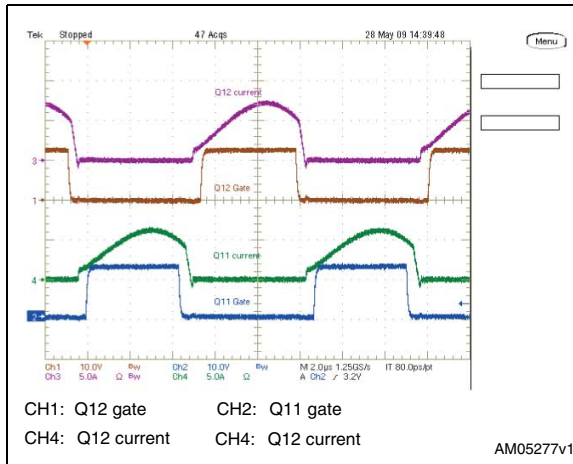
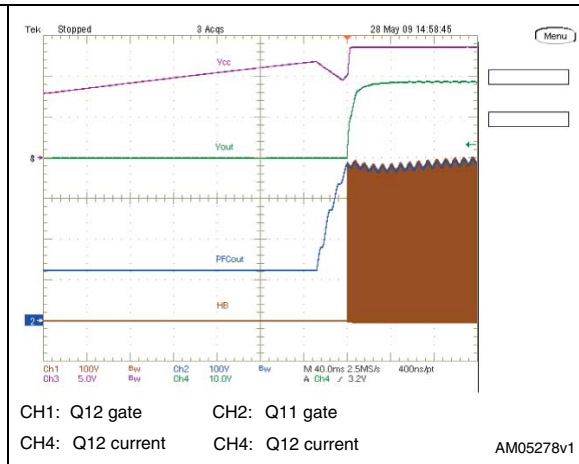

Figure 9. Startup sequencing at 230 V - 50 Hz



Standby and no-load operation

In *Figure 10* and *Figure 11*, some burst-mode waveforms are displayed. As illustrated, both the L6599A and L6563H operate in burst-mode. In *Figure 11* it can be observed that the PFC and LLC bursts are synchronized.

Figure 10. No load operation at 230 V - 50 Hz

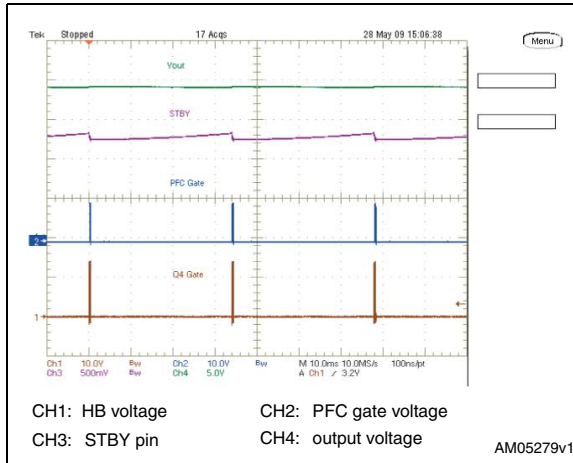
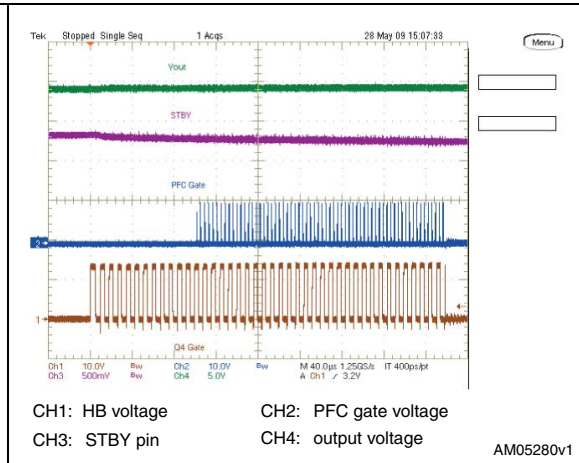

Figure 11. No load operation - detail at 230 V - 50 Hz



In *Figure 12* and *Figure 13* the transitions from full load to no load and vice-versa at maximum input voltage have been checked. The maximum input voltage has been chosen because it is the most critical input voltage for transition; in fact, at no load the burst pulses have the lower repetition frequency and the V_{CC} could drop, causing restart cycles of the controller. As visible in the images, both transitions are clean and there is no output voltage or V_{CC} dip.

Figure 12. Transition full load to no load at 265 Vac - 50 Hz

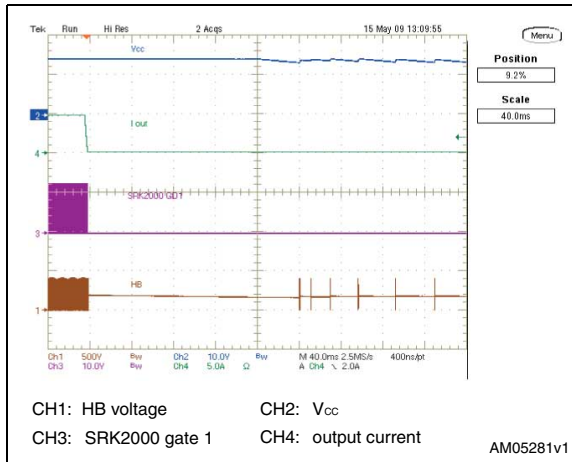
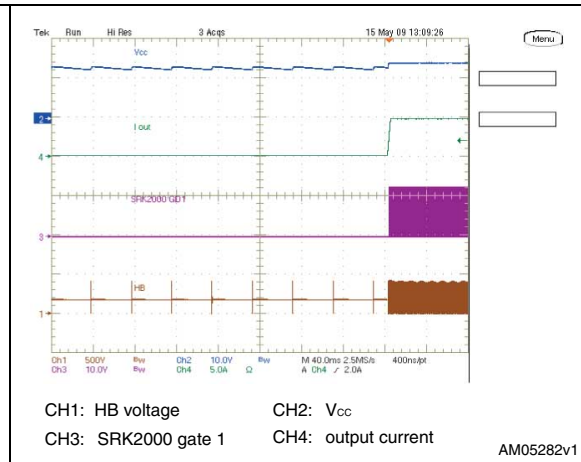

Figure 13. Transition no load to full load at 265 Vac - 50 Hz



Overcurrent and short-circuit protection

The L6599A is equipped with a current sensing input (pin 6, ISEN) and a dedicated overcurrent management system. The current flowing in the resonant tank is detected and the signal is fed to the ISEN pin. It is internally connected to a first comparator, referenced to 0.8 V, and to a second comparator referenced to 1.5 V. If the voltage externally applied to the pin exceeds 0.8 V, the first comparator is tripped, causing an internal switch to be turned on and discharging the soft-start capacitor CSS.

Under output short-circuit, this operation results in a nearly constant peak primary current.

With the L6599A, designers can externally program the maximum time that the converter is allowed to run in overload or short-circuit conditions. Overloads or short-circuits lasting less than the set time do not cause any protective action, thus providing the system with immunity to short-duration phenomena. If, instead, an overload condition continues, a protection procedure is activated that shuts down the L6599A and, in case of continuous overload/short-circuit, results in continuous intermittent operation with a user-defined duty cycle. This function is realized with the DELAY pin (pin 2) by means of a capacitor (C45) and the parallel resistor R24 connected to ground. If the voltage on the ISEN pin exceeds 0.8 V, the first OCP comparator, in addition to discharging CSS, turns on an internal 150 μ A current generator which, via the DELAY pin, charges C45. If the voltage on C45 is 3.5 V, the L6599A stops switching and the PFC_STOP pin is pulled low. Also, the internal generator is turned off, so that C45 is now slowly discharged by R24. The IC restarts when the voltage on C45 is less than 0.3 V. Additionally, if the voltage on the ISEN pin reaches 1.5 V for any reason (e.g. transformer saturation), the second comparator is triggered, the L6599A shuts down, and operation resumes after an off-on cycle.

Figure 14. Short-circuit at full load and 115 Vac - 60 Hz

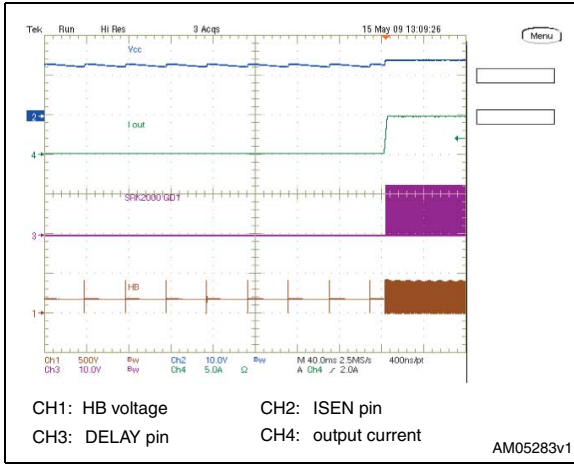
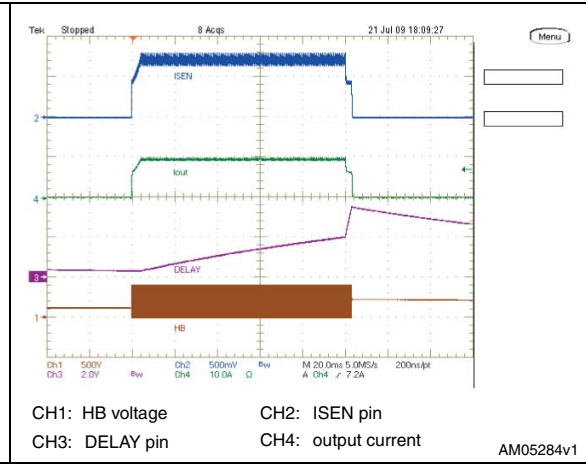

Figure 15. Short-circuit detail at full load and 115 Vac - 60 Hz



In the graphs above it can be noted that the average output current as well as the average primary current are limited, preventing converter over-heating and consequent failure.

5 Thermal map

In order to check design reliability, thermal mapping by means of an IR camera was done. Below, thermal measurements of the component side of the board at nominal input voltage are shown. The pointers on the images have been placed across key components. The ambient temperature during both measurements was 27 °C.

Figure 16. Thermal map at 115 Vac - 60 Hz - full load

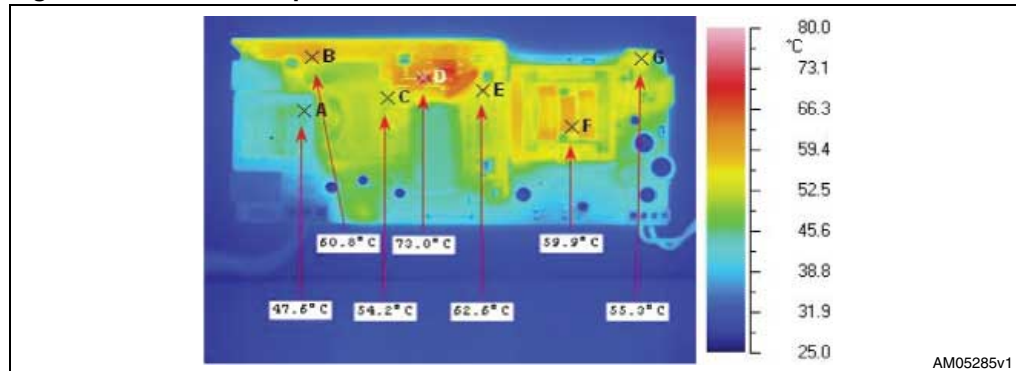

Figure 17. Thermal map at 230 Vac - 50 Hz - full load

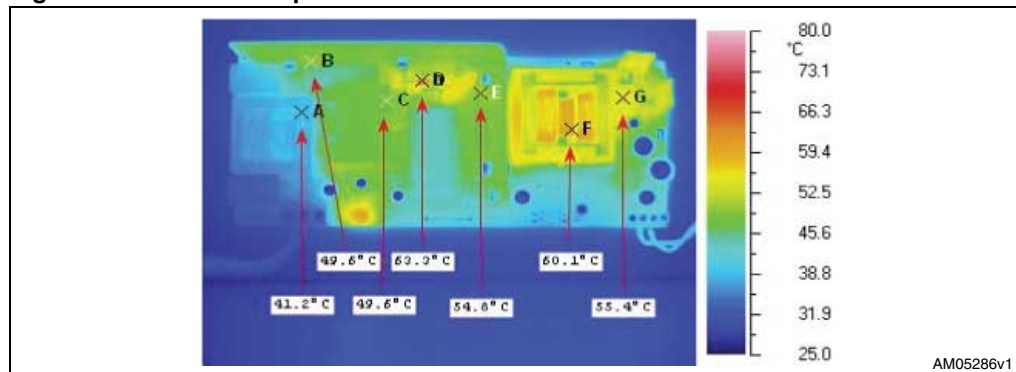

Table 4. Thermal map reference points

Point	Reference	Description
A	L1	EMI filtering inductor
B	D1	Bridge rectifier
C	L2	PFC inductor
D	D4	PFC output diode
E	Q3	Resonant high-side MOSFET
F	T1	Resonant power transformer
G	Q11	Output rectifier MOSFETs (hottest spot)

The pictures highlight that although both the synchronous rectifier MOSFETs at secondary side are working without a heatsink, their operating case temperature is lower than 60 °C.

6 Conducted emission pre-compliance test

The following figures represent the average measurement of the conducted noise at full load and nominal mains voltages. The limits shown on the diagrams are those of the EN55022 class-B standard, which is most popular standard for domestic equipment, and sets more severe limits compared to class-A, dedicated to IT technology equipment. As visible in the diagrams, under all test conditions the measurements are well below the limits.

Figure 18. CE average measurement at 115 Vac and full load

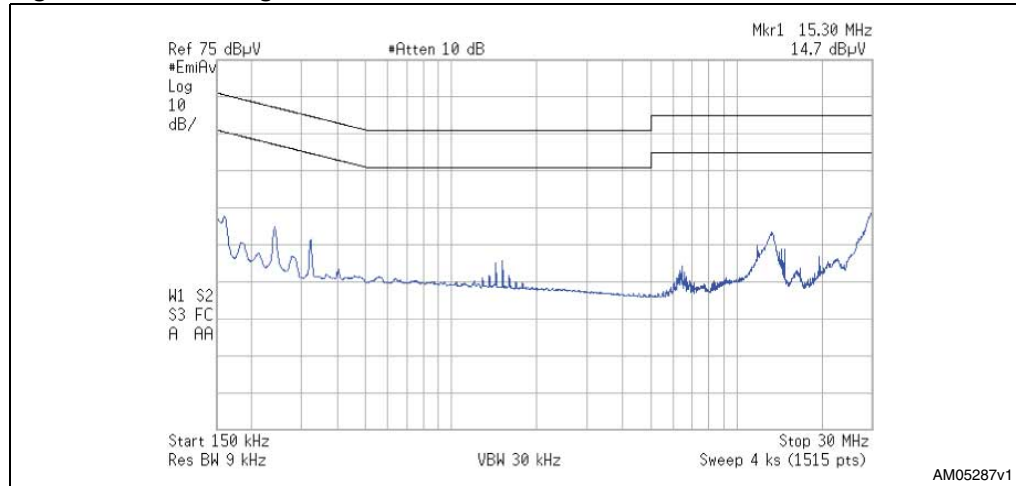
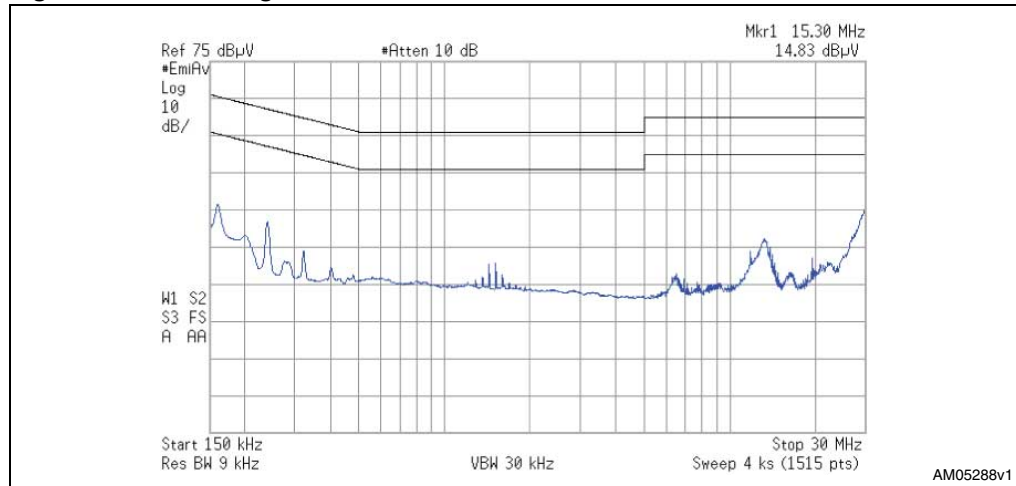

Figure 19. CE average measurement at 230 Vac and full load



7 Bill of material

Table 5. EVL90WADP-LLCSR demonstration board bill of material

Des.	Part type/part value	Description	Supplier	Case
C1	470 nF	X2 - FLM cap - R46-I 3470--M1-	ARCOTRONICS	9x18 mm P15 mm
C2	2.2 nF	Y1 safety cap. DE1E3KX222M	Murata	DWG
C3	2.2 nF	Y1 safety cap. DE1E3KX222M	Murata	DWG
C4	470 nF	X2 - FLM cap - R46-I 3470--M1-	ARCOTRONICS	9x18 mm P15 mm
C5	470 nF	400 V - FILM cap - B32653A4474	EPCOS	DWG
C6	4.7 nF	50 V CERCAP - general purpose	AVX	0805
C7	100 nF	100 V CERCAP - general purpose	AVX	PTH
C8	10 µF	Aluminum ELCAP - YXF series	Rubycon	Dia. 6.3x11 mm
C9	47 µF	450 V aluminum ELCAP - ED series	Panasonic	Dia. 18x32 mm
C10	1 nF	50 V CERCAP - general purpose	AVX	0805
C11	2.2 nF	50 V CERCAP - general purpose	AVX	0805
C12	1 µF	25 V CERCAP - general purpose	AVX	0805
C13	680 nF	25 V CERCAP - general purpose	AVX	1206
C14	68 nF	50 V CERCAP - general purpose	AVX	0805
C15	47 µF	50 V aluminum ELCAP - YXF series	Rubycon	Dia. 6.3x11 mm
C16	2.2 nF	50 V CERCAP - general purpose	AVX	1206
C17	470 pF	50 V - 5% - C0G - CERCAP	AVX	0805
C18	2.2 µF	6.3 V CERCAP - general purpose	AVX	1206
C19	100 nF	50 V CERCAP - general purpose	AVX	1206
C20	2.2 nF	Y1 safety cap. DE1E3KX222M	Murata	DWG
C21	2.2 nF	Y1 safety cap. DE1E3KX222M	Murata	DWG
C22	220 pF	50 V CERCAP - general purpose	AVX	0805
C23	10 nF	50 V CERCAP - general purpose	AVX	0805
C24	100 µF	50 V aluminum ELCAP-YXF series	Rubycon	Dia. 10x12.5 mm
C25	330 nF	50 V CERCAP - general purpose	AVX	0805
C26	10 µF	50 V aluminum ELCAP - YXF series	Rubycon	Dia. 6.3x11 mm
C27	220 pF	500 V CERCAP - 5MQ221KAAAA	AVX	5x3 mm
C28	22 nF	630 V - PHE450MA5220JR05	KEMET	16x8 mm
C29	470 µF	35 V aluminum ELCAP - YXF series	Rubycon	Dia. 12.5x20 mm
C30	470 µF	35 V aluminum ELCAP - YXF series	Rubycon	Dia. 12.5x20 mm
C31	220 µF	35 V aluminum ELCAP - FM series	Panasonic	D8x16
C32	100 nF	50 V CERCAP - general purpose	AVX	0805

Table 5. EVL90WADP-LLCSR demonstration board bill of material (continued)

Des.	Part type/part value	Description	Supplier	Case
C34	220 nF	50 V CERCAP - general purpose	AVX	0805
C36	1 μ F	50 V aluminum ELCAP - YXF series	Rubycon	Dia. 6.3x11 mm
C39	100 nF	50 V CERCAP - general purpose	AVX	0805
C40	100 nF	50 V CERCAP - general purpose	AVX	1206
C41	100 nF	50 V CERCAP - general purpose	AVX	0805
C42	100 nF	50 V CERCAP - general purpose	AVX	1206
C43	4.7 nF	50 V CERCAP - general purpose	AVX	1206
C44	10 nF	50 V CERCAP - general purpose	AVX	1206
C45	220 nF	25 V CERCAP - general purpose	AVX	0805
C48	10 μ F	50 V aluminum ELCAP - YXF series	Rubycon	Dia. 6.3x11 mm
D1	GBU4J	Single-phase bridge rectifier	Vishay	GBU
D2	LL4148	High-speed signal diode	Vishay	SOD-80
D3	1N4005	General purpose rectifier	Vishay	DO-41
D4	STTH2L06	Ultrafast high-voltage rectifier	STMicroelectronics	DO-41
D5	LL4148	High-speed signal diode	Vishay	SOD-80
D7	LL4148	High-speed signal diode	Vishay	SOD-80
D8	BZV55-B27	Zener diode	Vishay	SOD-80
D9	STPS1L60A	Power Schottky rectifier	STMicroelectronics	SMA
D10	LL4148	High-speed signal diode	Vishay	SOD-80
D11	LL4148	High-speed signal diode	Vishay	SOD-80
D15	BZV55-C15	Zener diode	Vishay	SOD-80
D16	LL4148	High-speed signal diode	Vishay	SOD-80
D18	LL4148	High-speed signal diode	Vishay	SOD-80
D19	LL4148	High-speed signal diode	Vishay	SOD-80
D20	BZV55-B15	Zener diode	Vishay	SOD-80
D22	LL4148	Fast switching diode	Vishay	SOD-80
F1	Fuse T4A	Fuse 4 A - time lag - 3921400	Littelfuse	P 5.08 mm
HS1	Heatsink	Heatsink for D1, Q1, Q3, Q4		DWG
J1	MKDS 1,5/ 3-5,08	PCB term. block, screw conn., - 3 wires	Phoenix Contact	P 5.08 mm
J2	MKDS 1,5/ 2-5,08	PCB term. block, screw conn., - 2 wires	Phoenix Contact	P 5.08 mm
L1	HF2826-123Y1R8-T01	Input EMI filter	TDK	DWG
L2	1974.0002	PFC inductor - 0.52 mH	Magnetica	DWG
L3	1073.0083	1 μ H - 5 A inductor	Magnetica	DWG
Q1	STF12NM50N	N-channel power MOSFET	STMicroelectronics	TO-220FP
Q3	STP8NM50FP	N-channel power MOSFET	STMicroelectronics	TO-220FP

Table 5. EVL90WADP-LLCSR demonstration board bill of material (continued)

Des.	Part type/part value	Description	Supplier	Case
Q4	STP8NM50FP	N-channel power MOSFET	STMicroelectronics	TO-220FP
Q5	BC847C	NPN small signal BJT	Vishay	SOT-23
Q6	BC847C	NPN small signal BJT	Vishay	SOT-23
Q9	BC847C	NPN small signal BJT	Vishay	SOT-23
Q11	STF60N55F3	N-channel power MOSFET	STMicroelectronics	TO-220FP
Q12	STF60N55F3	N-channel power MOSFET	STMicroelectronics	TO-220FP
R1	3.3 M Ω	SMD film res - 1/4 W - 5% - 250 ppm/ $^{\circ}$ C	Vishay	1206
R2	3.3 M Ω	SMD film res - 1/4 W - 5% - 250 ppm/ $^{\circ}$ C	Vishay	1206
R3	1 M Ω	SMD film res - 1/4 W - 1% - 100 ppm/ $^{\circ}$ C	Vishay	1206
R4	2.2 M Ω	SMD film res - 1/8 W - 5% - 250 ppm/ $^{\circ}$ C	Vishay	0805
R5	10 Ω	SMD film res - 1/4 W - 5% - 250 ppm/ $^{\circ}$ C	Vishay	1206
R6	NTC 2R5-S237	NTC resistor P/N B57237S0259M000	EPCOS	DWG
R7	1 M Ω	SMD film res - 1/4 W - 1% - 100 ppm/ $^{\circ}$ C	Vishay	1206
R8	1 M Ω	SMD film res - 1/4 W - 1% - 100 ppm/ $^{\circ}$ C	Vishay	1206
R9	62 k Ω	SMD film res - 1/8 W - 1% - 100 ppm/ $^{\circ}$ C	Vishay	0805
R10	27 k Ω	SMD film res - 1/8 W - 1% - 100 ppm/ $^{\circ}$ C	Vishay	0805
R11	2.2 M Ω	SMD film res - 1/4 W - 1% - 100 ppm/ $^{\circ}$ C	Vishay	1206
R12	2.2 M Ω	SMD film res - 1/4 W - 1% - 100 ppm/ $^{\circ}$ C	Vishay	1206
R13	10 k Ω	SMD film res - 1/4 W - 1% - 100 ppm/ $^{\circ}$ C	Vishay	1206
R14	51 k Ω	SMD film res - 1/8 W - 5% - 250 ppm/ $^{\circ}$ C	Vishay	0805
R15	56 k Ω	SMD film res - 1/4 W - 1% - 100 ppm/ $^{\circ}$ C	Vishay	1206
R16	4.7 k Ω	SMD film res - 1/8 W - 5% - 250 ppm/ $^{\circ}$ C	Vishay	0805
R17	2.2 k Ω	SMD film res - 1/4 W - 1% - 100 ppm/ $^{\circ}$ C	Vishay	1206
R18	82 k Ω	SMD film res - 1/8 W - 5% - 250 ppm/ $^{\circ}$ C	Vishay	0805
R19	56 k Ω	SMD film res - 1/8 W - 5% - 250 ppm/ $^{\circ}$ C	Vishay	0805
R21	39 Ω	SMD film res - 1/8 W - 5% - 250 ppm/ $^{\circ}$ C	Vishay	0805
R22	0.47 Ω	Axial film res - 0.4 W - 5% - 250 ppm/ $^{\circ}$ C	Vishay	PTH
R23	0.82 Ω	Axial film res - 0.4 W - 5% - 250 ppm/ $^{\circ}$ C	Vishay	PTH
R24	1 M Ω	SMD film res - 1/8 W - 5% - 250 ppm/ $^{\circ}$ C	Vishay	0805
R25	56 Ω	SMD film res - 1/8 W - 5% - 250 ppm/ $^{\circ}$ C	Vishay	0805
R26	1 M Ω	SMD film res - 1/8 W - 1% - 100 ppm/ $^{\circ}$ C	Vishay	0805
R27	470 Ω	SMD film res - 1/4 W - 5% - 250 ppm/ $^{\circ}$ C	Vishay	1206
R28	33 k Ω	SMD film res - 1/8 W - 1% - 100 ppm/ $^{\circ}$ C	Vishay	0805
R29	1.0 k Ω	SMD film res - 1/4 W - 5% - 250 ppm/ $^{\circ}$ C	Vishay	1206
R30	10 Ω	SMD film res - 1/8 W - 5% - 250 ppm/ $^{\circ}$ C	Vishay	0805

Table 5. EVL90WADP-LLCSR demonstration board bill of material (continued)

Des.	Part type/part value	Description	Supplier	Case
R31	15 k Ω	SMD film res - 1/8 W - 1% - 100 ppm/ $^{\circ}$ C	Vishay	0805
R32	47 Ω	SMD film res - 1/8 W - 5% - 250 ppm/ $^{\circ}$ C	Vishay	0805
R34	3.3 k Ω	SMD film res - 1/4 W - 5% - 250 ppm/ $^{\circ}$ C	Vishay	1206
R35	180 k Ω	SMD film res - 1/8 W - 1% - 100 ppm/ $^{\circ}$ C	Vishay	0805
R37	220 k Ω	SMD film res - 1/4 W - 5% - 250 ppm/ $^{\circ}$ C	Vishay	1206
R38	56 Ω	SMD film res - 1/8 W - 5% - 250 ppm/ $^{\circ}$ C	Vishay	0805
R39	130 Ω	SMD film res - 1/8 W - 5% - 250 ppm/ $^{\circ}$ C	Vishay	0805
R40	0.0 Ω	SMD film res - 1/4 W - 5% - 250 ppm/ $^{\circ}$ C	Vishay	1206
R41	100 Ω	Axial film res-0.4 W - 5% - 250 ppm/ $^{\circ}$ C	Vishay	PTH
R42	4.7 k Ω	SMD film res - 1/8 W - 5% - 250 ppm/ $^{\circ}$ C	Vishay	0805
R43	51 Ω	SMD film res - 1/8 W - 5% - 250 ppm/ $^{\circ}$ C	Vishay	0805
R44	4.3 k Ω	SMD film res - 1/4 W - 5% - 250 ppm/ $^{\circ}$ C	Vishay	1206
R46	100 k Ω	SMD film res - 1/8 W - 5% - 250 ppm/ $^{\circ}$ C	Vishay	0805
R47	1.0 k Ω	SMD film res - 1/8 W - 5% - 250 ppm/ $^{\circ}$ C	Vishay	0805
R48	100 k Ω	SMD film res - 1/8 W - 5% - 250 ppm/ $^{\circ}$ C	Vishay	0805
R49	39 k Ω	SMD film res - 1/8 W - 1% - 100 ppm/ $^{\circ}$ C	Vishay	0805
R50	6.2 k Ω	SMD film res - 1/8 W - 1% - 100 ppm/ $^{\circ}$ C	Vishay	0805
R51	120 k Ω	SMD film res - 1/8 W - 1% - 100 ppm/ $^{\circ}$ C	Vishay	0805
R53	0.0 Ω	SMD film res - 1/8 W - 5% - 250 ppm/ $^{\circ}$ C	Vishay	0805
R54	0.0 Ω	SMD film res - 1/8 W - 5% - 250 ppm/ $^{\circ}$ C	Vishay	0805
R56	18 k Ω	SMD film res - 1/8 W - 5% - 250 ppm/ $^{\circ}$ C	Vishay	0805
R58	100 k Ω	SMD film res - 1/8 W - 5% - 250 ppm/ $^{\circ}$ C	Vishay	0805
R59	100 k Ω	SMD film res - 1/8 W - 5% - 250 ppm/ $^{\circ}$ C	Vishay	0805
R60	10 k Ω	SMD film res - 1/8 W - 5% - 250 ppm/ $^{\circ}$ C	Vishay	0805
R62	4.7 k Ω	SMD film res - 1/8 W - 5% - 250 ppm/ $^{\circ}$ C	Vishay	0805
R63	27 Ω	SMD film res - 1/8 W - 5% - 250 ppm/ $^{\circ}$ C	Vishay	0805
R64	27 Ω	SMD film res - 1/8 W - 5% - 250 ppm/ $^{\circ}$ C	Vishay	0805
R65	47 k Ω	SMD film res - 1/8 W - 5% - 250 ppm/ $^{\circ}$ C	Vishay	0805
R66	2.2 k Ω	SMD film res - 1/4 W - 5% - 250 ppm/ $^{\circ}$ C	Vishay	1206
R68	7.5 k Ω	SMD film res - 1/8 W - 5% - 250 ppm/ $^{\circ}$ C	Vishay	0805
R69	4.7 k Ω	SMD film res - 1/8 W - 5% - 250 ppm/ $^{\circ}$ C	Vishay	0805
R74	3.9 k Ω	SMD film res - 1/8 W - 5% - 250 ppm/ $^{\circ}$ C	Vishay	0805
R75	3.9 k Ω	SMD film res - 1/8 W - 5% - 250 ppm/ $^{\circ}$ C	Vishay	0805
R76	100 k Ω	SMD film res - 1/8 W - 5% - 250 ppm/ $^{\circ}$ C	Vishay	0805
R77	100 k Ω	SMD film res - 1/8 W - 5% - 250 ppm/ $^{\circ}$ C	Vishay	0805

Table 5. EVL90WADP-LLCSR demonstration board bill of material (continued)

Des.	Part type/part value	Description	Supplier	Case
R78	33 k Ω	SMD film res - 1/8 W - 5% - 250 ppm/ $^{\circ}$ C	Vishay	0805
R79	150 k Ω	SMD film res - 1/8 W - 5% - 250 ppm/ $^{\circ}$ C	Vishay	0805
R80	0.0 Ω	SMD film res - 1/4 W - 5% - 250 ppm/ $^{\circ}$ C	Vishay	1206
T1	1860.0025	Resonant power transformer	Magnetica	DWG
U1	L6563H	High voltage startup TM PFC controller	STMicroelectronics	SO-16
U3	SFH617A-2	Optocoupler	Infineon	DIP-4
U4	TL431AIZ	Programmable shunt voltage reference	STMicroelectronics	TO-92
U5	SRK2000	Synch. rect. driver for LLC res conv	STMicroelectronics	SO-8
U6	L6599A	Improved HV resonant controller	STMicroelectronics	SO-16

8 PFC coil specification

General description and characteristics

- Application type: consumer, home appliance
- Transformer type: open
- Coil former: vertical type, 6+6 pins
- Max. temperature rise: 45 °C
- Max. operating ambient temperature: 60 °C
- Mains insulation: N.A.
- Unit finishing: varnished

Electrical characteristics

- Converter topology: boost, transition mode
- Core type: PQ26/20-PC44 or equivalent
- Min. operating frequency: 40 kHz
- Typical operating frequency: 120 kHz
- Primary inductance: 520 $\mu\text{H} \pm 10\%$ at 1 kHz - 0.25 V (see note below)
- Peak primary current: 4.2 Apk

Note: Measured between pins 5 and 9.

Electrical diagram and winding characteristics

Figure 20. PFC coil electrical

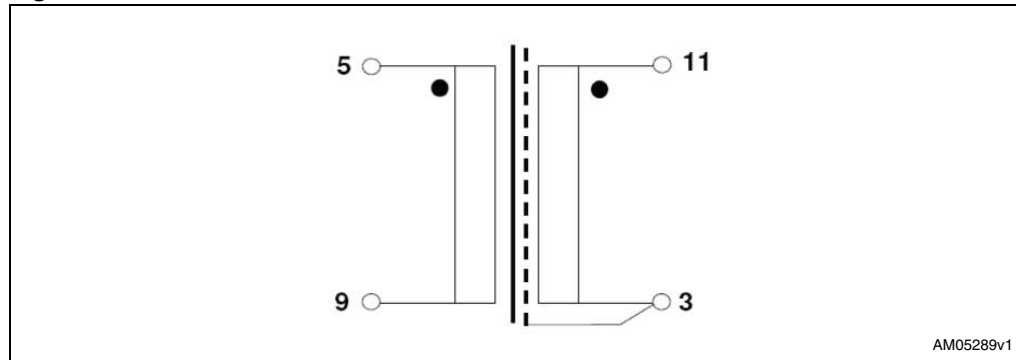

AM05289v1

Table 6. PFC coil winding data

Pins	Windings	RMS current	Number of turns	Wire type
11 - 3	AUX	0.05 A _{RMS}	5.5	ϕ 0.28 mm – G2
5 - 9	Primary	1.4 A _{RMS}	57.5	30x ϕ 0.1 mm – G1

Mechanical aspect and pin numbering

- Maximum height from PCB: 22 mm
- Coil former type: vertical, 6+6 pins (pins 1, 2, 4, 6, 7, 10, 12 are removed)
- Pin distance: 3.81 mm
- Row distance: 25 mm
- External copper shield: not insulated, wound around the ferrite core and including the coil former. Height is 8 mm. Connected to pin 3 by a soldered solid wire.

Figure 21. PFC coil mechanical aspect

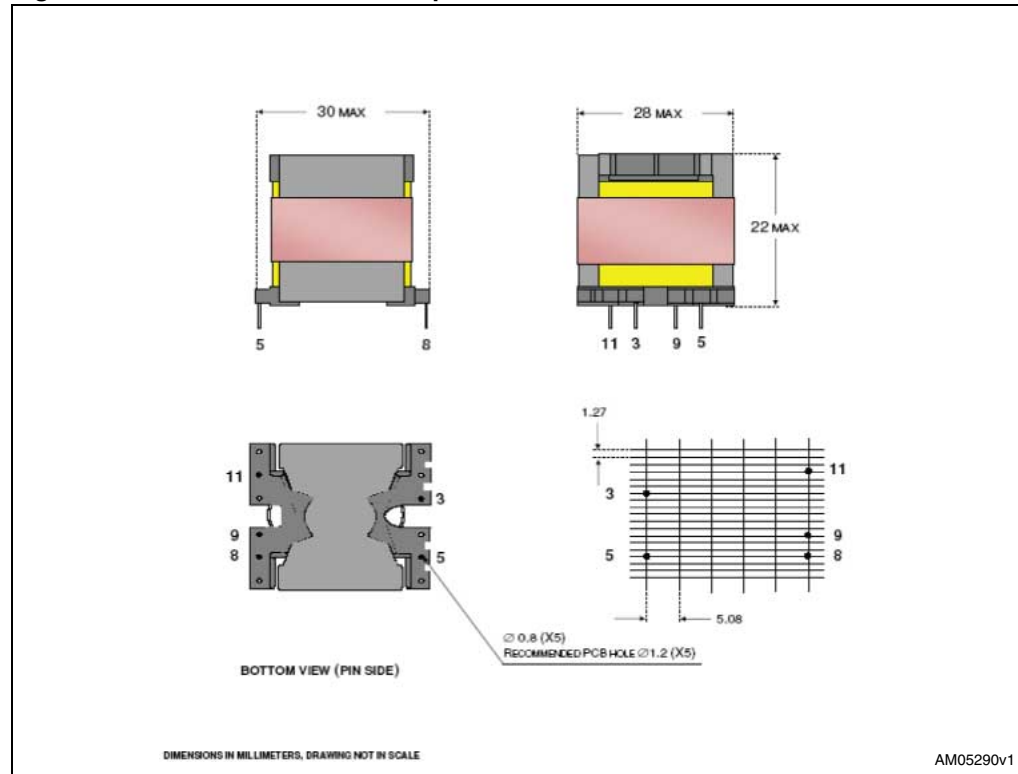

Manufacturer

- Magnetica - Italy
- Inductor P/N: 1974.0002

9 Transformer specification

General description and characteristics

- Application type: consumer, home appliance
- Transformer type: open
- Coil former: horizontal type, 7+7 pins, two slots
- Max. temperature rise: 45 °C
- Max. operating ambient temperature: 60 °C
- Mains insulation: in accordance with EN60950

Electrical characteristics

- Converter topology: half bridge, resonant
- Core type: ETD34-PC44 or equivalent
- Min. operating frequency: 60 kHz
- Typical operating frequency: 100 kHz
- Primary inductance: 1200 $\mu\text{H} \pm 10\%$ at 1 kHz - 0.25 V (see [Note 1](#))
- Leakage inductance: 200 $\mu\text{H} \pm 10\%$ at 100 kHz - 0.25 V (see [Note 2](#))

Note: 1 Measured between pins 2-4

2 Measured between pins 2-4 with only one secondary winding shorted

Electrical diagram and winding characteristics

Figure 22. Transformer electrical diagram

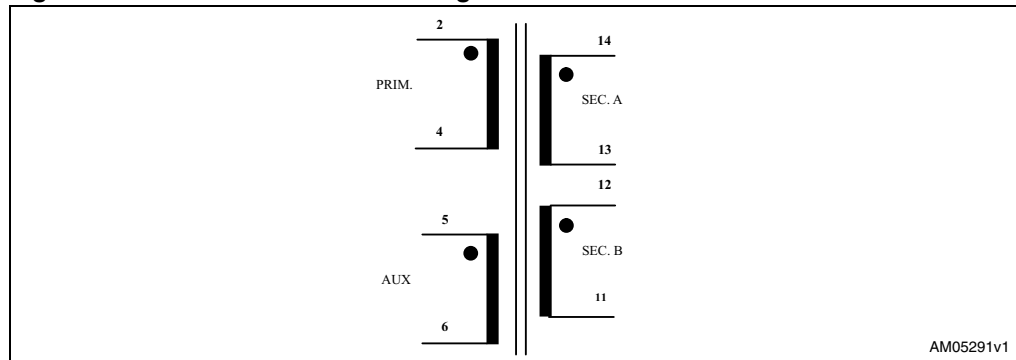

Table 7. Transformer winding data

Pins	Winding	RMS current	Number of turns	Wire type
2-4	Primary	1 A _{RMS}	50	30x ϕ 0.1 mm – G1
14-13	Sec - A ⁽¹⁾	4 A _{RMS}	5	90x ϕ 0.1 mm – G1
12-11	Sec – B ⁽¹⁾	4 A _{RMS}	5	90x ϕ 0.1 mm – G1
5-6	Aux ⁽²⁾	0.05 A _{RMS}	4	ϕ 0.28 mm – G2

1. Secondary windings A and B are in parallel

- Aux winding is wound on top of primary winding

Mechanical aspect and pin numbering

- Maximum height from PCB: 30 mm
- Coil former type: horizontal, 7+7 pins (pins 1 and 7 are removed)
- Pin distance: 5.08 mm
- Row distance: 25.4 mm

Figure 23. Transformer overall drawing

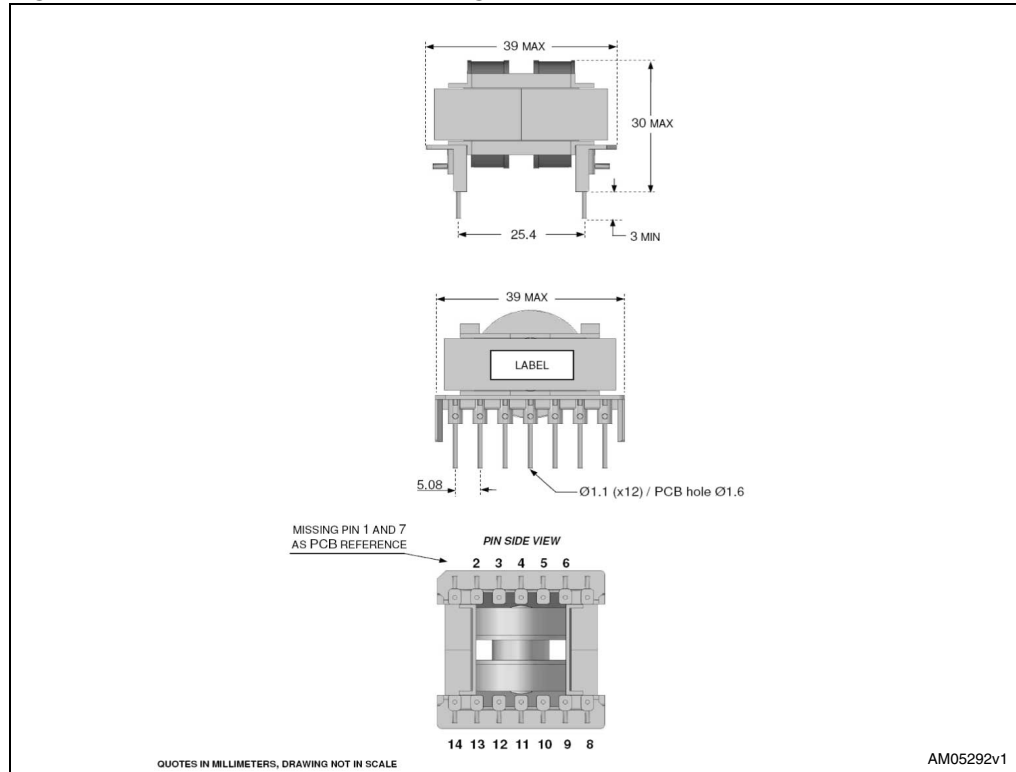

Manufacturer

- Magnetica - Italy
- Transformer P/N: 1860.0025

10 Revision history

Table 8. Document revision history

Date	Revision	Changes
22-Mar-2010	1	Initial release.
13-Dec-2010	2	Updated <i>Chapter 1</i>

Please Read Carefully:

Information in this document is provided solely in connection with ST products. STMicroelectronics NV and its subsidiaries ("ST") reserve the right to make changes, corrections, modifications or improvements, to this document, and the products and services described herein at any time, without notice.

All ST products are sold pursuant to ST's terms and conditions of sale.

Purchasers are solely responsible for the choice, selection and use of the ST products and services described herein, and ST assumes no liability whatsoever relating to the choice, selection or use of the ST products and services described herein.

No license, express or implied, by estoppel or otherwise, to any intellectual property rights is granted under this document. If any part of this document refers to any third party products or services it shall not be deemed a license grant by ST for the use of such third party products or services, or any intellectual property contained therein or considered as a warranty covering the use in any manner whatsoever of such third party products or services or any intellectual property contained therein.

UNLESS OTHERWISE SET FORTH IN ST'S TERMS AND CONDITIONS OF SALE ST DISCLAIMS ANY EXPRESS OR IMPLIED WARRANTY WITH RESPECT TO THE USE AND/OR SALE OF ST PRODUCTS INCLUDING WITHOUT LIMITATION IMPLIED WARRANTIES OF MERCHANTABILITY, FITNESS FOR A PARTICULAR PURPOSE (AND THEIR EQUIVALENTS UNDER THE LAWS OF ANY JURISDICTION), OR INFRINGEMENT OF ANY PATENT, COPYRIGHT OR OTHER INTELLECTUAL PROPERTY RIGHT.

UNLESS EXPRESSLY APPROVED IN WRITING BY AN AUTHORIZED ST REPRESENTATIVE, ST PRODUCTS ARE NOT RECOMMENDED, AUTHORIZED OR WARRANTED FOR USE IN MILITARY, AIR CRAFT, SPACE, LIFE SAVING, OR LIFE SUSTAINING APPLICATIONS, NOR IN PRODUCTS OR SYSTEMS WHERE FAILURE OR MALFUNCTION MAY RESULT IN PERSONAL INJURY, DEATH, OR SEVERE PROPERTY OR ENVIRONMENTAL DAMAGE. ST PRODUCTS WHICH ARE NOT SPECIFIED AS "AUTOMOTIVE GRADE" MAY ONLY BE USED IN AUTOMOTIVE APPLICATIONS AT USER'S OWN RISK.

Resale of ST products with provisions different from the statements and/or technical features set forth in this document shall immediately void any warranty granted by ST for the ST product or service described herein and shall not create or extend in any manner whatsoever, any liability of ST.

ST and the ST logo are trademarks or registered trademarks of ST in various countries.

Information in this document supersedes and replaces all information previously supplied.

The ST logo is a registered trademark of STMicroelectronics. All other names are the property of their respective owners.

© 2010 STMicroelectronics - All rights reserved

STMicroelectronics group of companies

Australia - Belgium - Brazil - Canada - China - Czech Republic - Finland - France - Germany - Hong Kong - India - Israel - Italy - Japan - Malaysia - Malta - Morocco - Philippines - Singapore - Spain - Sweden - Switzerland - United Kingdom - United States of America

www.st.com

