

# LM2731

## 0.6/1.6 MHz Boost Converters With 22V Internal FET Switch in SOT-23

### General Description

The LM2731 switching regulators are current-mode boost converters operating at fixed frequencies of 1.6 MHz ("X" option) and 600 kHz ("Y" option).

The use of SOT-23 package, made possible by the minimal power loss of the internal 1.8A switch, and use of small inductors and capacitors result in the industry's highest power density. The 22V internal switch makes these solutions perfect for boosting to voltages up to 20V.

These parts have a logic-level shutdown pin that can be used to reduce quiescent current and extend battery life.

Protection is provided through cycle-by-cycle current limiting and thermal shutdown. Internal compensation simplifies design and reduces component count.

Switch Frequency

X	Y
1.6 MHz	0.6 MHz

### Features

- 22V DMOS FET switch
- 1.6 MHz ("X"), 0.6 MHz ("Y") switching frequency
- Low  $R_{DS(ON)}$  DMOS FET
- Switch current up to 1.8A
- Wide input voltage range (2.7V–14V)
- Low shutdown current (<1  $\mu$ A)
- 5-Lead SOT-23 package
- Uses tiny capacitors and inductors
- Cycle-by-cycle current limiting
- Internally compensated

### Applications

- White LED Current Source
- PDA's and Palm-Top Computers
- Digital Cameras
- Portable Phones and Games
- Local Boost Regulator

### Typical Application Circuit

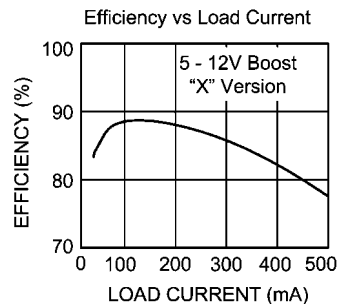
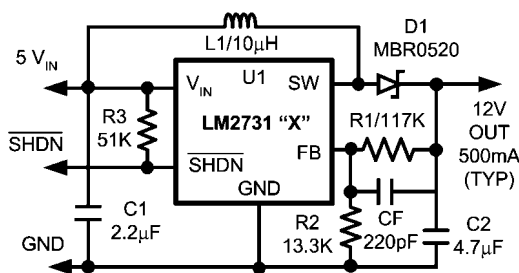

20059110

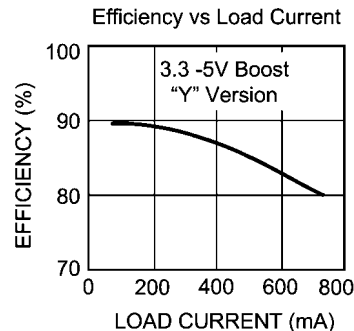
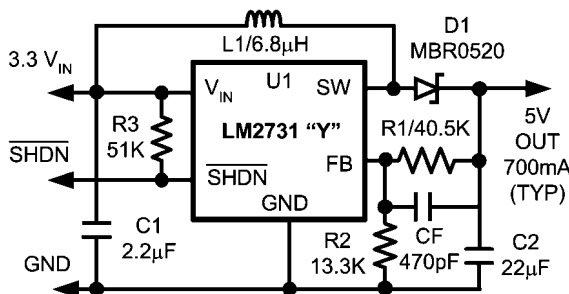

20059130

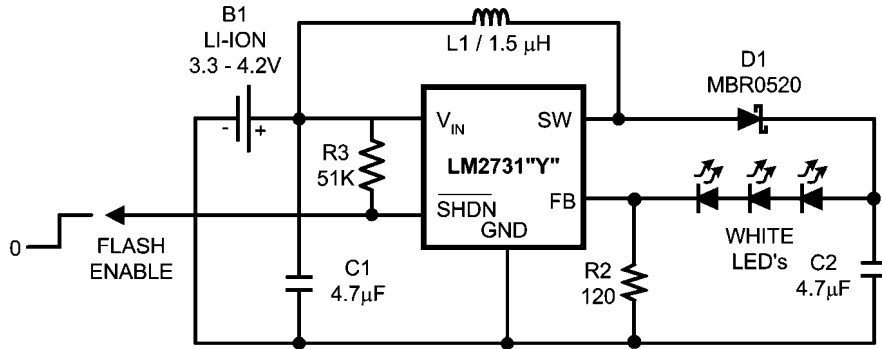
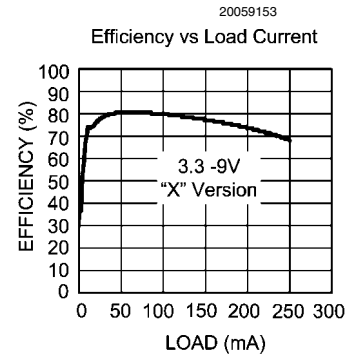
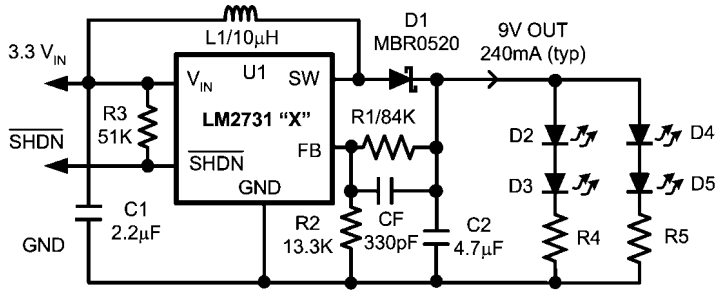
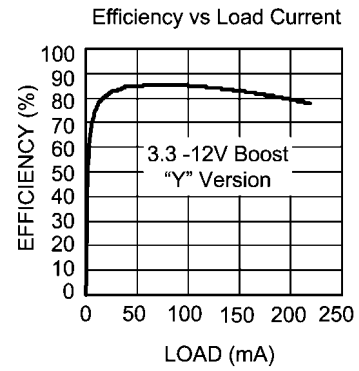
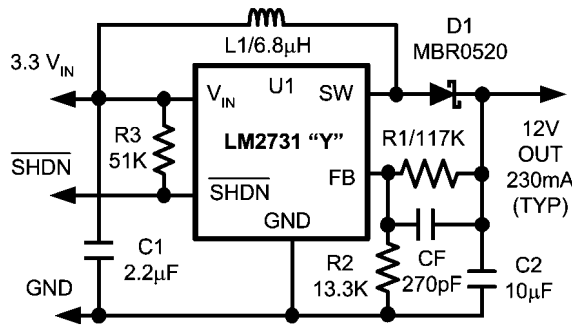

White LED Flash Application

## Connection Diagram

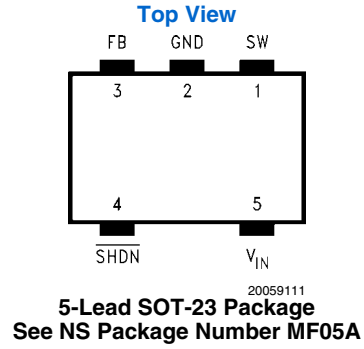

## Ordering Information

Order Number	Package Type	Package Drawing	Supplied As	Package ID
LM2731XMF	SOT23-5	MF05A	1K Tape and Reel	S51A
LM2731XMF <sub>X</sub>			3K Tape and Reel	S51A
LM2731YMF			1K Tape and Reel	S51B
LM2731YMF <sub>X</sub>			3K Tape and Reel	S51B

## Pin Descriptions

Pin	Name	Function
1	SW	Drain of the internal FET switch.
2	GND	Analog and power ground.
3	FB	Feedback point that connects to external resistive divider.
4	SHDN	Shutdown control input. Connect to $V_{IN}$ if the feature is not used.
5	$V_{IN}$	Analog and power input.

## Absolute Maximum Ratings *(Note 1)*

If Military/Aerospace specified devices are required, please contact the National Semiconductor Sales Office/Distributors for availability and specifications.

Storage Temperature Range	-65°C to +150°C
Operating Junction Temperature Range	-40°C to +125°C
Lead Temp. (Soldering, 5 sec.)	300°C

Power Dissipation *(Note 2)*

FB Pin Voltage	-0.4V to +6V
SW Pin Voltage	-0.4V to +22V
Input Supply Voltage	-0.4V to +14.5V
SHDN Pin Voltage	-0.4V to $V_{IN} + 0.3V$
$\theta_{J-A}$ (SOT23-5)	265°C/W
ESD Rating <i>(Note 3)</i> Human Body Model	2 kV

Internally Limited

## Electrical Characteristics

Limits in standard typeface are for  $T_J = 25^\circ\text{C}$ , and limits in **boldface type** apply over the full operating temperature range ( $-40^\circ\text{C} \leq T_J \leq +125^\circ\text{C}$ ). Unless otherwise specified:  $V_{IN} = 5V$ ,  $V_{SHDN} = 5V$ ,  $I_L = 0A$ .

Symbol	Parameter	Conditions	Min <i>(Note 4)</i>	Typical <i>(Note 5)</i>	Max <i>(Note 4)</i>	Units
$V_{IN}$	Input Voltage		<b>2.7</b>		<b>14</b>	V
$V_{OUT(MIN)}$	Minimum Output Voltage Under Load	$R_L = 43\Omega$ X Option <i>(Note 8)</i>	$V_{IN} = 2.7V$ <b>5.4</b>	7		V
			$V_{IN} = 3.3V$ <b>8</b>	10		
			$V_{IN} = 5V$ <b>13</b>	17		
		$R_L = 43\Omega$ Y Option <i>(Note 8)</i>	$V_{IN} = 2.7V$ <b>8.25</b>	10		
			$V_{IN} = 3.3V$ <b>10.5</b>	12		
			$V_{IN} = 5V$ <b>14</b>	16		
		$R_L = 15\Omega$ X Option <i>(Note 8)</i>	$V_{IN} = 2.7V$ <b>3.75</b>	5		
			$V_{IN} = 3.3V$ <b>5</b>	6.5		
			$V_{IN} = 5V$ <b>8.75</b>	11		
		$R_L = 15\Omega$ Y Option <i>(Note 8)</i>	$V_{IN} = 2.7V$ <b>5</b>	6		
			$V_{IN} = 3.3V$ <b>5.5</b>	7.5		
			$V_{IN} = 5V$ <b>9</b>	11		
$I_{SW}$	Switch Current Limit	<i>(Note 6)</i>	1.8 <b>1.4</b>	2		A
$R_{DS(ON)}$	Switch ON Resistance	$I_{SW} = 100\text{ mA}$ $V_{in} = 5V$		260	400 <b>500</b>	$m\Omega$
		$I_{SW} = 100\text{ mA}$ $V_{in} = 3.3V$		300	450 <b>550</b>	
$SHDN_{TH}$	Shutdown Threshold	Device ON	<b>1.5</b>			V
		Device OFF			<b>0.50</b>	
$I_{SHDN}$	Shutdown Pin Bias Current	$V_{SHDN} = 0$		0		$\mu\text{A}$
		$V_{SHDN} = 5V$		0	<b>2</b>	
$V_{FB}$	Feedback Pin Reference Voltage	$V_{IN} = 3V$	<b>1.205</b>	1.230	<b>1.255</b>	V
$I_{FB}$	Feedback Pin Bias Current	$V_{FB} = 1.23V$		60	<b>500</b>	nA
$I_Q$	Quiescent Current	$V_{SHDN} = 5V$ , Switching "X"		2	<b>3.0</b>	mA
		$V_{SHDN} = 5V$ , Switching "Y"		1.0	<b>2</b>	
		$V_{SHDN} = 5V$ , Not Switching		400	<b>500</b>	$\mu\text{A}$
		$V_{SHDN} = 0$		0.024	1	
$\frac{\Delta V_{FB}}{\Delta V_{IN}}$	FB Voltage Line Regulation	$2.7V \leq V_{IN} \leq 14V$		0.02		%/V
$F_{SW}$	Switching Frequency <i>(Note 7)</i>	"X" Option	<b>1</b>	1.6	<b>1.85</b>	MHz
		"Y" Option	<b>0.40</b>	0.60	<b>0.8</b>	

Symbol	Parameter	Conditions	Min (Note 4)	Typical (Note 5)	Max (Note 4)	Units
D <sub>MAX</sub>	Maximum Duty Cycle (Note 7)	"X" Option	86	93		%
		"Y" Option	92	96		
I <sub>L</sub>	Switch Leakage	Not Switching V <sub>SW</sub> = 5V			1	μA

**Note 1:** Absolute Maximum Ratings indicate limits beyond which damage to the component may occur. Electrical specifications do not apply when operating the device outside of the limits set forth under the operating ratings which specify the intended range of operating conditions.

**Note 2:** The maximum power dissipation which can be safely dissipated for any application is a function of the maximum junction temperature, T<sub>J</sub>(MAX) = 125°C, the junction-to-ambient thermal resistance for the SOT-23 package, θ<sub>J-A</sub> = 265°C/W, and the ambient temperature, T<sub>A</sub>. The maximum allowable power dissipation at any ambient temperature for designs using this device can be calculated using the formula:

$$P(\text{MAX}) = \frac{T_J(\text{MAX}) - T_A}{\theta_{J-A}} = \frac{125 - T_A}{265}$$

If power dissipation exceeds the maximum specified above, the internal thermal protection circuitry will protect the device by reducing the output voltage as required to maintain a safe junction temperature.

**Note 3:** The human body model is a 100 pF capacitor discharged through a 1.5 kΩ resistor into each pin.

**Note 4:** Limits are guaranteed by testing, statistical correlation, or design.

**Note 5:** Typical values are derived from the mean value of a large quantity of samples tested during characterization and represent the most likely expected value of the parameter at room temperature.

**Note 6:** Switch current limit is dependent on duty cycle (see Typical Performance Characteristics).

**Note 7:** Guaranteed limits are the same for V<sub>IN</sub> = 3.3V input.

**Note 8:** L = 10 μH, C<sub>OUT</sub> = 4.7 μF, duty cycle = maximum

## Typical Performance Characteristics

Unless otherwise specified: V<sub>IN</sub> = 5V,  $\overline{\text{SHDN}}$  pin tied to V<sub>IN</sub>.

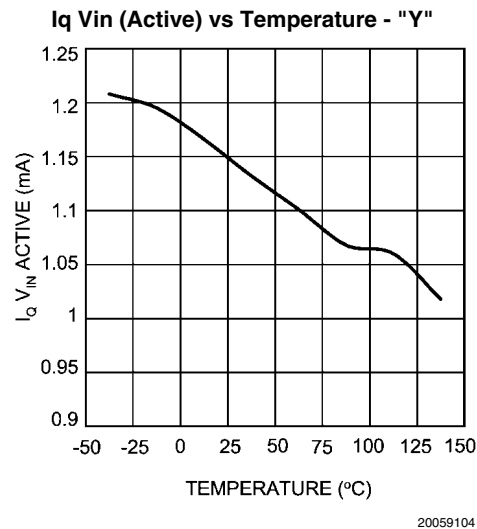
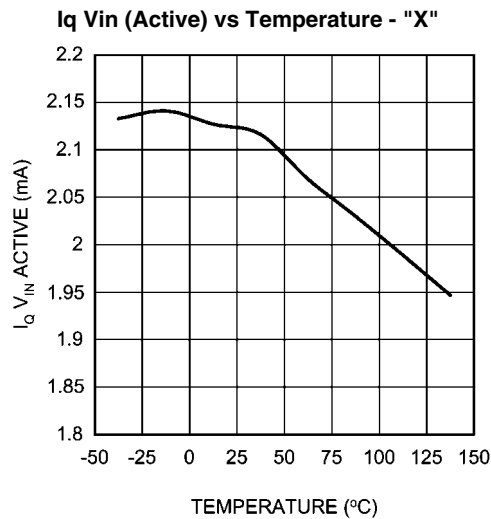

Oscillator Frequency vs Temperature - "X"

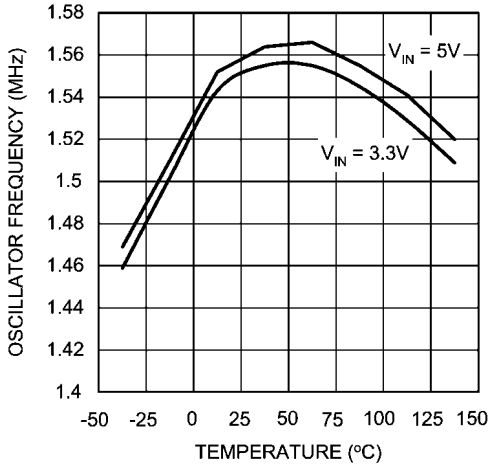

20059105

Oscillator Frequency vs Temperature - "Y"

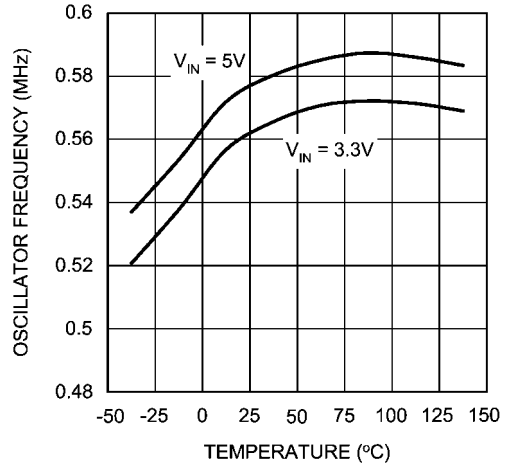

20059101

Max. Duty Cycle vs Temperature - "X"

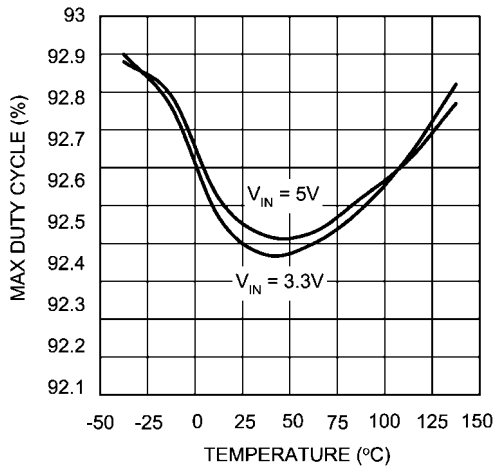

20059107

Max. Duty Cycle vs Temperature - "Y"

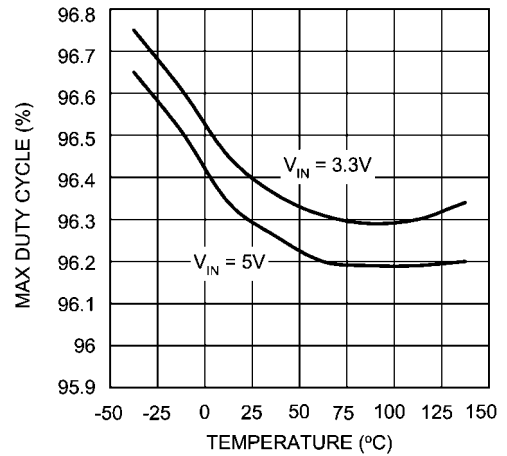

20059106

Iq Vin (Idle) vs Temperature

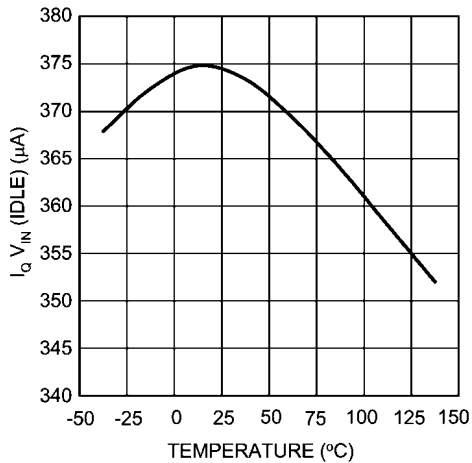

20059125

Feedback Bias Current vs Temperature

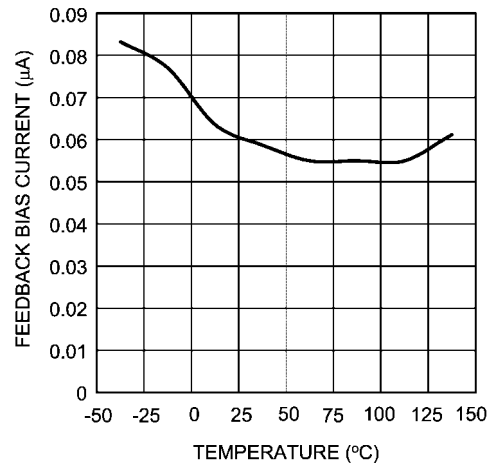

20059126

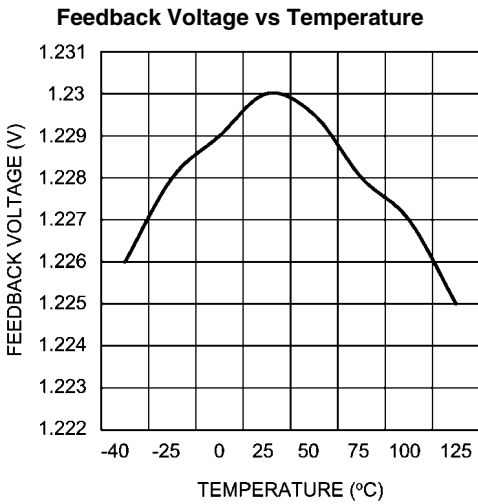

20059127

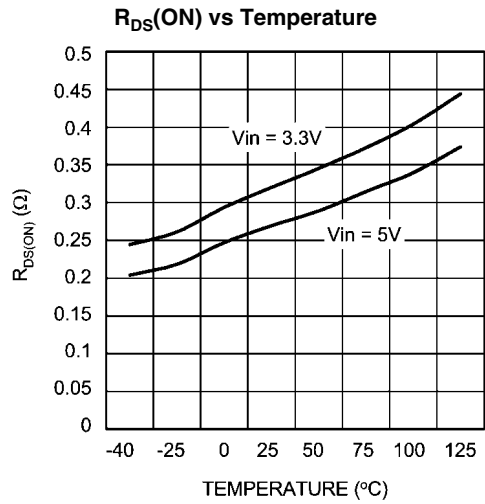

20059128

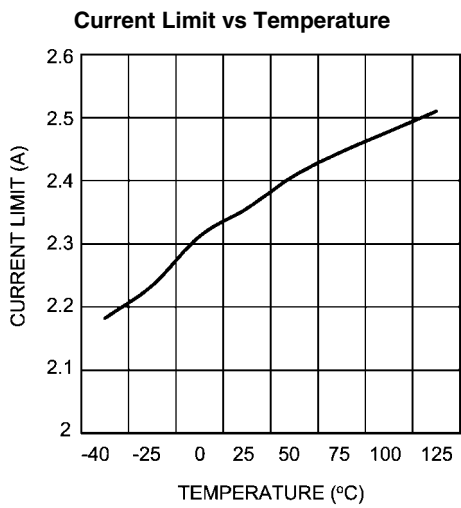

20059129

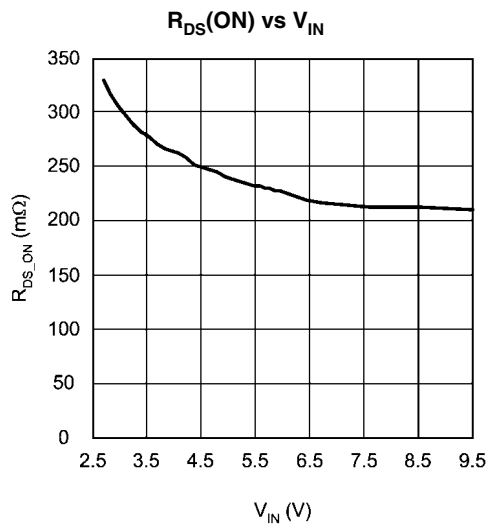

20059152

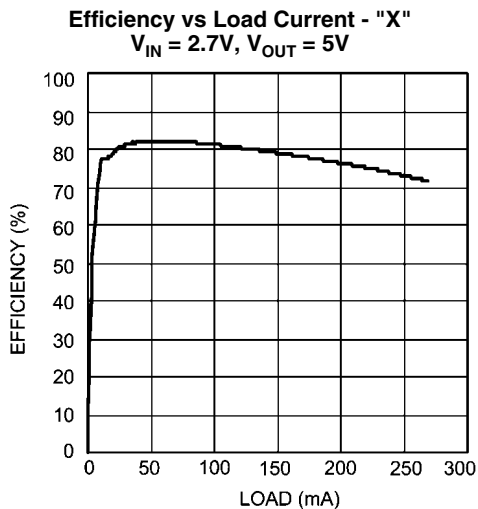

20059135

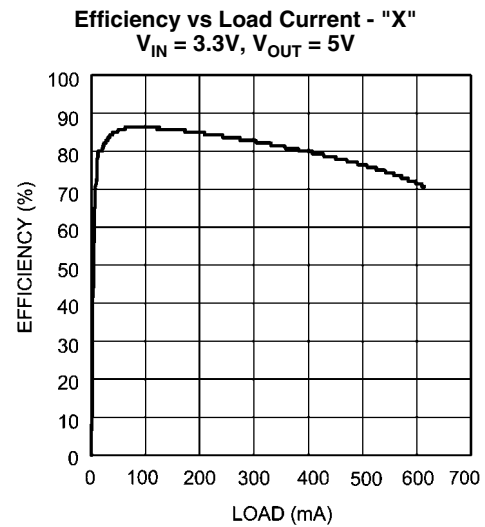

20059136

Efficiency vs Load Current - "X"  
 $V_{IN} = 4.2V, V_{OUT} = 5V$

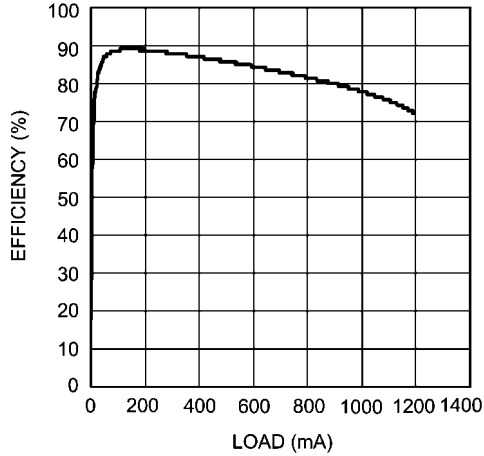

20059137

Efficiency vs Load Current - "X"  
 $V_{IN} = 2.7V, V_{OUT} = 12V$

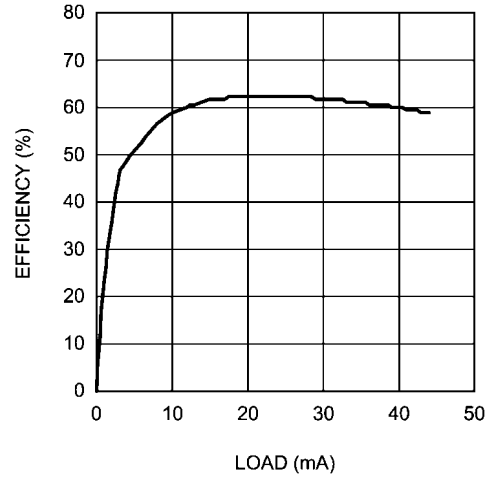

20059138

Efficiency vs Load Current - "X"  
 $V_{IN} = 3.3V, V_{OUT} = 12V$

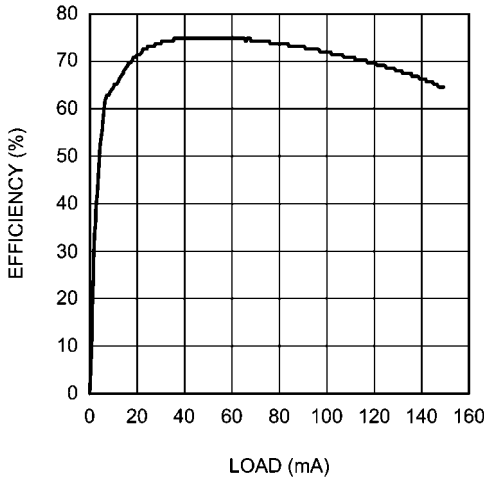

20059139

Efficiency vs Load Current - "X"  
 $V_{IN} = 5V, V_{OUT} = 12V$

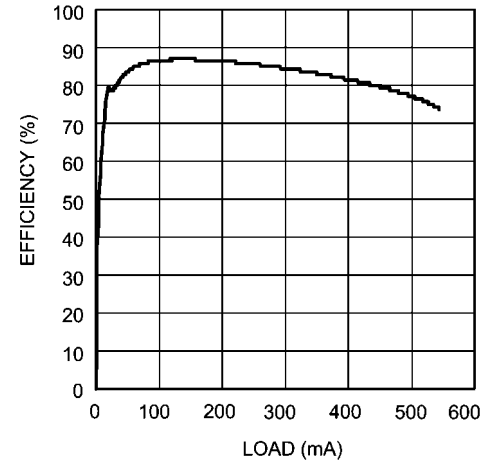

20059140

Efficiency vs Load Current - "X"  
 $V_{IN} = 5V, V_{OUT} = 18V$

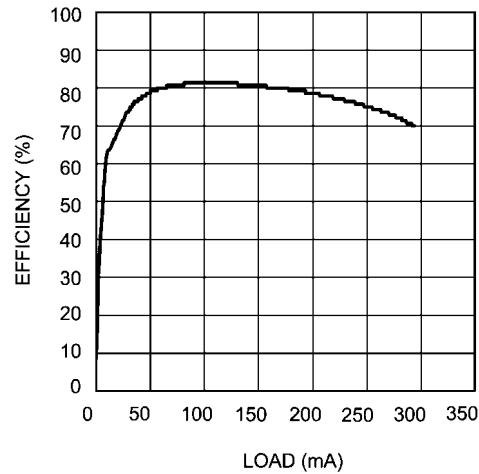

20059141

Efficiency vs Load Current - "Y"  
 $V_{IN} = 2.7V, V_{OUT} = 5V$

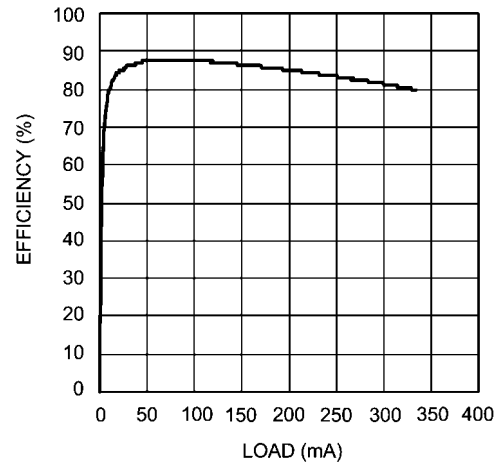

20059142



Efficiency vs Load Current - "Y"  
 $V_{IN} = 3.3V, V_{OUT} = 5V$

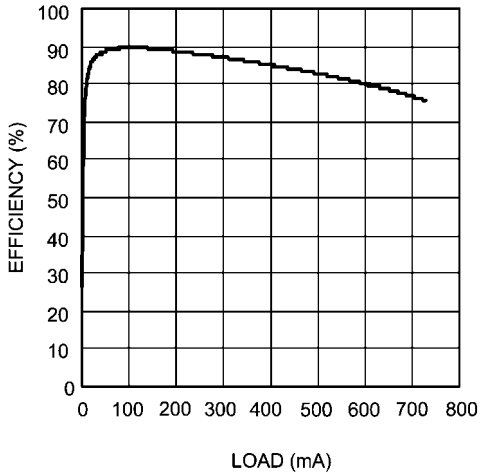

20059143

Efficiency vs Load Current - "Y"  
 $V_{IN} = 4.2V, V_{OUT} = 5V$

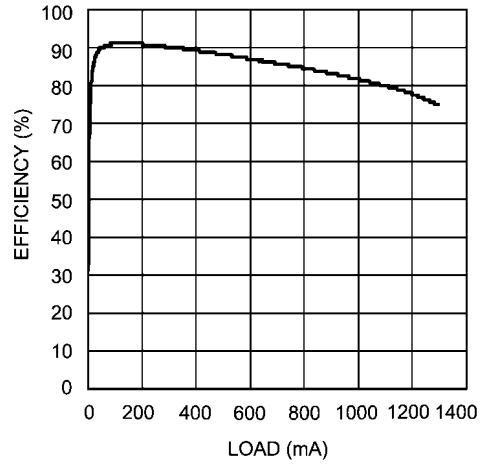

20059144

Efficiency vs Load Current - "Y"  
 $V_{IN} = 2.7V, V_{OUT} = 12V$

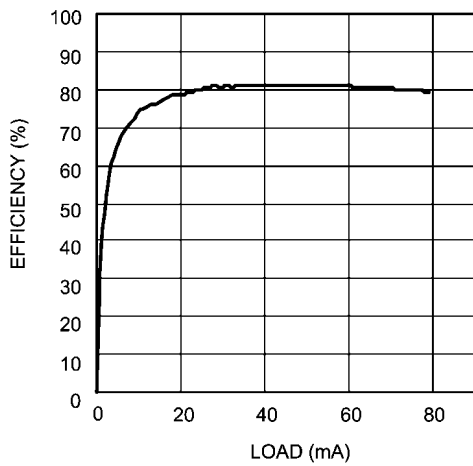

20059145

Efficiency vs Load Current - "Y"  
 $V_{IN} = 3.3V, V_{OUT} = 12V$

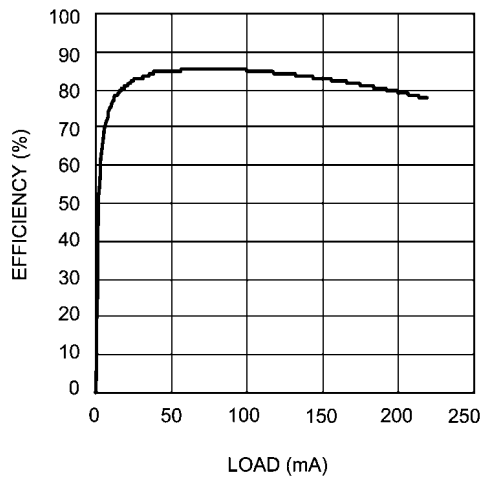

20059146

Efficiency vs Load Current - "Y"  
 $V_{IN} = 5V, V_{OUT} = 12V$

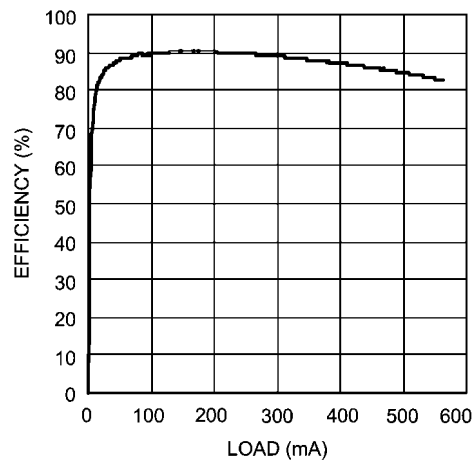

20059147

## Block Diagram

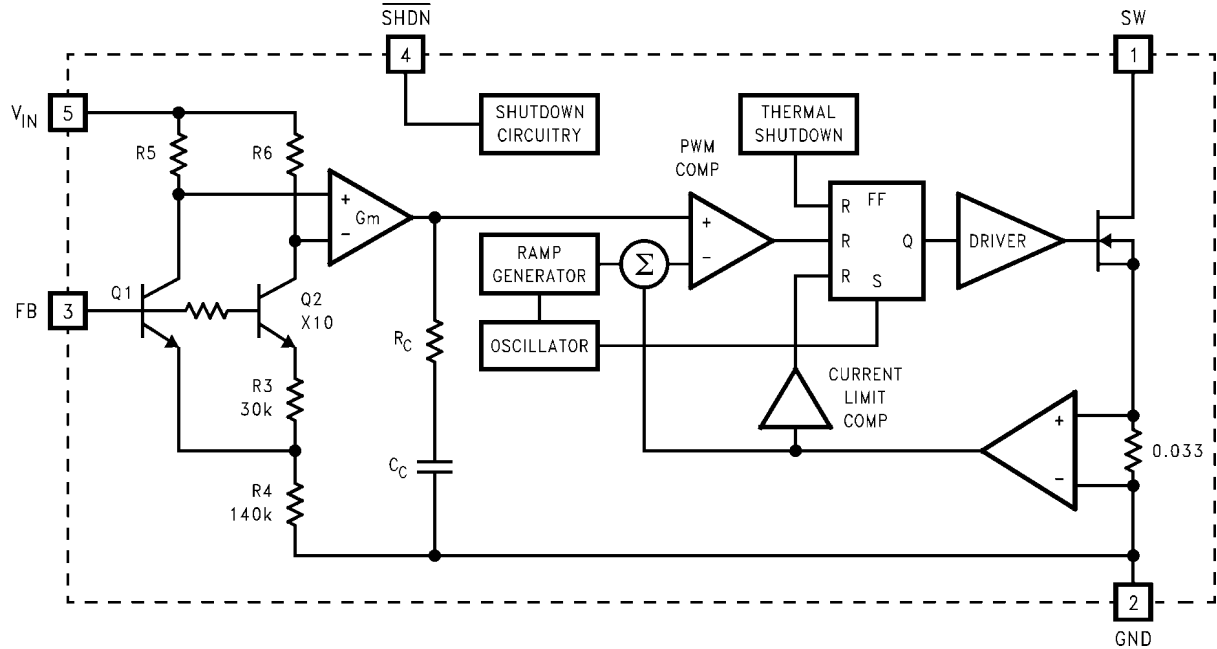

20059112

## Theory of Operation

The LM2731 is a switching converter IC that operates at a fixed frequency (0.6 or 1.6 MHz) for fast transient response over a wide input voltage range and incorporates pulse-by-pulse current limiting protection. Because this is current mode control, a 33 mΩ sense resistor in series with the switch FET is used to provide a voltage (which is proportional to the FET current) to both the input of the pulse width modulation (PWM) comparator and the current limit amplifier.

At the beginning of each cycle, the S-R latch turns on the FET. As the current through the FET increases, a voltage (proportional to this current) is summed with the ramp coming from the ramp generator and then fed into the input of the PWM comparator. When this voltage exceeds the voltage on the other input (coming from the Gm amplifier), the latch resets and turns the FET off. Since the signal coming from the Gm amplifier is derived from the feedback (which samples the voltage at the output), the action of the PWM comparator constantly sets the correct peak current through the FET to keep the output voltage in regulation.

Q1 and Q2 along with R3 - R6 form a bandgap voltage reference used by the IC to hold the output in regulation. The currents flowing through Q1 and Q2 will be equal, and the feedback loop will adjust the regulated output to maintain this. Because of this, the regulated output is always maintained at a voltage level equal to the voltage at the FB node "multiplied up" by the ratio of the output resistive divider.

The current limit comparator feeds directly into the flip-flop that drives the switch FET. If the FET current reaches the limit threshold, the FET is turned off and the cycle terminated until the next clock pulse. The current limit input terminates the pulse regardless of the status of the output of the PWM comparator.

## Application Hints

### SELECTING THE EXTERNAL CAPACITORS

The best capacitors for use with the LM2731 are multi-layer ceramic capacitors. They have the lowest ESR (equivalent series resistance) and highest resonance frequency which makes them optimum for use with high frequency switching converters.

When selecting a ceramic capacitor, only X5R and X7R dielectric types should be used. Other types such as Z5U and Y5F have such severe loss of capacitance due to effects of temperature variation and applied voltage, they may provide as little as 20% of rated capacitance in many typical applications. Always consult capacitor manufacturer's data curves before selecting a capacitor. High-quality ceramic capacitors can be obtained from Taiyo-Yuden, AVX, and Murata.

### SELECTING THE OUTPUT CAPACITOR

A single ceramic capacitor of value 4.7 μF to 10 μF will provide sufficient output capacitance for most applications. If larger amounts of capacitance are desired for improved line support and transient response, tantalum capacitors can be used. Aluminum electrolytics with ultra low ESR such as Sanyo Oscon can be used, but are usually prohibitively expensive. Typical Al electrolytic capacitors are not suitable for switching frequencies above 500 kHz due to significant ringing and temperature rise due to self-heating from ripple current. An output capacitor with excessive ESR can also reduce phase margin and cause instability.

In general, if electrolytics are used, it is recommended that they be paralleled with ceramic capacitors to reduce ringing, switching losses, and output voltage ripple.

### SELECTING THE INPUT CAPACITOR

An input capacitor is required to serve as an energy reservoir for the current which must flow into the coil each time the switch turns ON. This capacitor must have extremely low ESR, so ceramic is the best choice. We recommend a nominal value of 2.2 μF, but larger values can be used. Since this

capacitor reduces the amount of voltage ripple seen at the input pin, it also reduces the amount of EMI passed back along that line to other circuitry.

### FEED-FORWARD COMPENSATION

Although internally compensated, the feed-forward capacitor  $C_f$  is required for stability (see *Basic Application Circuit*). Adding this capacitor puts a zero in the loop response of the converter. The recommended frequency for the zero  $f_z$  should be approximately 6 kHz.  $C_f$  can be calculated using the formula:

$$C_f = 1 / (2 \times \pi \times R_1 \times f_z)$$

### SELECTING DIODES

The external diode used in the typical application should be a Schottky diode. A 20V diode such as the MBR0520 is recommended.

The MBR05XX series of diodes are designed to handle a maximum average current of 0.5A. For applications exceeding 0.5A average but less than 1A, a Microsemi UPS5817 can be used.

### LAYOUT HINTS

High frequency switching regulators require very careful layout of components in order to get stable operation and low noise. All components must be as close as possible to the LM2731 device. It is recommended that a 4-layer PCB be used so that internal ground planes are available.

As an example, a recommended layout of components is shown:

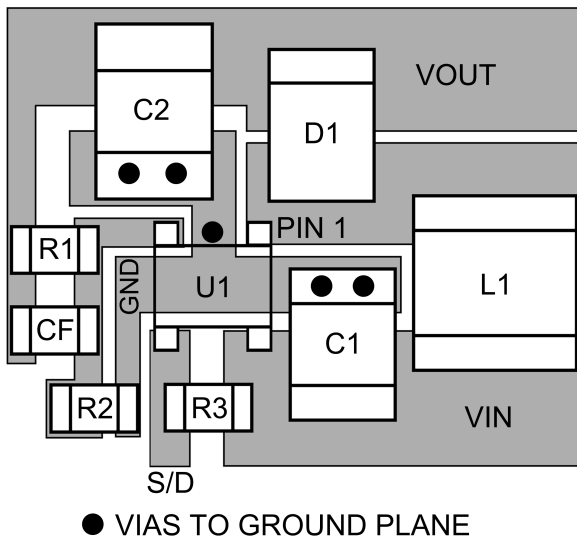

Recommended PCB Component Layout

20059116

Some additional guidelines to be observed:

1. Keep the path between L1, D1, and C2 extremely short. Parasitic trace inductance in series with D1 and C2 will increase noise and ringing.
2. The feedback components R1, R2 and CF must be kept close to the FB pin of U1 to prevent noise injection on the FB pin trace.
3. If internal ground planes are available (recommended) use vias to connect directly to ground at pin 2 of U1, as well as the negative sides of capacitors C1 and C2.

### SETTING THE OUTPUT VOLTAGE

The output voltage is set using the external resistors R1 and R2 (see *Basic Application Circuit*). A value of approximately 13.3 k $\Omega$  is recommended for R2 to establish a divider current of approximately 92  $\mu$ A. R1 is calculated using the formula:

$$R_1 = R_2 \times (V_{OUT}/1.23 - 1)$$

### SWITCHING FREQUENCY

The LM2731 is provided with two switching frequencies: the "X" version is typically 1.6 MHz, while the "Y" version is typically 600 kHz. The best frequency for a specific application must be determined based on the trade-offs involved:

Higher switching frequency means the inductors and capacitors can be made smaller and cheaper for a given output voltage and current. The down side is that efficiency is slightly lower because the fixed switching losses occur more frequently and become a larger percentage of total power loss. EMI is typically worse at higher switching frequencies because more EMI energy will be seen in the higher frequency spectrum where most circuits are more sensitive to such interference.

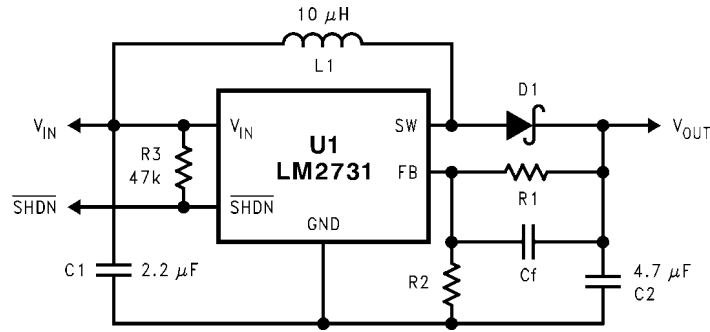

20059117

Basic Application Circuit

### DUTY CYCLE

The maximum duty cycle of the switching regulator determines the maximum boost ratio of output-to-input voltage that the converter can attain in continuous mode of operation. The duty cycle for a given boost application is defined as:

$$\text{Duty Cycle} = \frac{V_{\text{OUT}} + V_{\text{DIODE}} - V_{\text{IN}}}{V_{\text{OUT}} + V_{\text{DIODE}} - V_{\text{SW}}}$$

This applies for continuous mode operation.

### INDUCTANCE VALUE

The first question we are usually asked is: "How small can I make the inductor?" (because they are the largest sized component and usually the most costly). The answer is not simple and involves trade-offs in performance. Larger inductors mean less inductor ripple current, which typically means less output voltage ripple (for a given size of output capacitor). Larger inductors also mean more load power can be delivered because the energy stored during each switching cycle is:

$$E = L/2 \times (I_p)^2$$

Where "p" is the peak inductor current. An important point to observe is that the LM2731 will limit its switch current based on peak current. This means that since  $I_p(\text{max})$  is fixed, increasing L will increase the maximum amount of power available to the load. Conversely, using too little inductance may limit the amount of load current which can be drawn from the output.

Best performance is usually obtained when the converter is operated in "continuous" mode at the load current range of interest, typically giving better load regulation and less output ripple. Continuous operation is defined as not allowing the inductor current to drop to zero during the cycle. It should be noted that all boost converters shift over to discontinuous operation as the output load is reduced far enough, but a larger inductor stays "continuous" over a wider load current range.

To better understand these trade-offs, a typical application circuit (5V to 12V boost with a 10 μH inductor) will be analyzed. We will assume:

$$V_{\text{IN}} = 5\text{V}, V_{\text{OUT}} = 12\text{V}, V_{\text{DIODE}} = 0.5\text{V}, V_{\text{SW}} = 0.5\text{V}$$

Since the frequency is 1.6 MHz (nominal), the period is approximately 0.625 μs. The duty cycle will be 62.5%, which means the ON time of the switch is 0.390 μs. It should be noted that when the switch is ON, the voltage across the inductor is approximately 4.5V.

Using the equation:

$$V = L (di/dt)$$

We can then calculate the di/dt rate of the inductor which is found to be 0.45 A/μs during the ON time. Using these facts, we can then show what the inductor current will look like during operation:

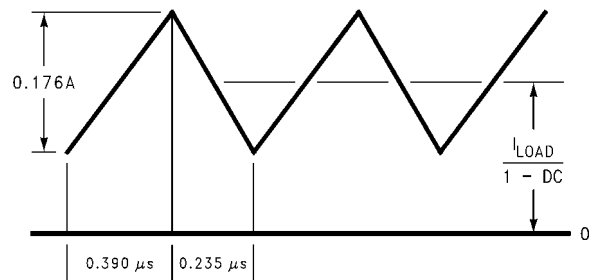

20059118

10 μH Inductor Current,  
5V-12V Boost (LM2731X)

During the 0.390 μs ON time, the inductor current ramps up to 0.176A and ramps down an equal amount during the OFF time. This is defined as the inductor "ripple current". It can also be seen that if the load current drops to about 33 mA, the inductor current will begin touching the zero axis which means it will be in discontinuous mode. A similar analysis can be performed on any boost converter, to make sure the ripple current is reasonable and continuous operation will be maintained at the typical load current values.

### MAXIMUM SWITCH CURRENT

The maximum FET switch current available before the current limiter cuts in is dependent on duty cycle of the application. This is illustrated in the graphs below which show typical values of switch current for both the "X" and "Y" versions as a function of effective (actual) duty cycle:

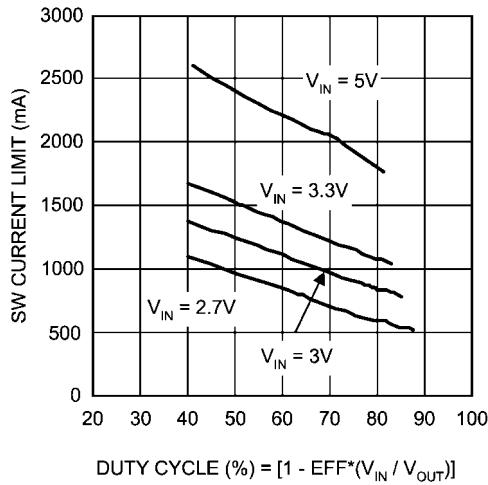

20059150  
**Switch Current Limit vs Duty Cycle - "X"**

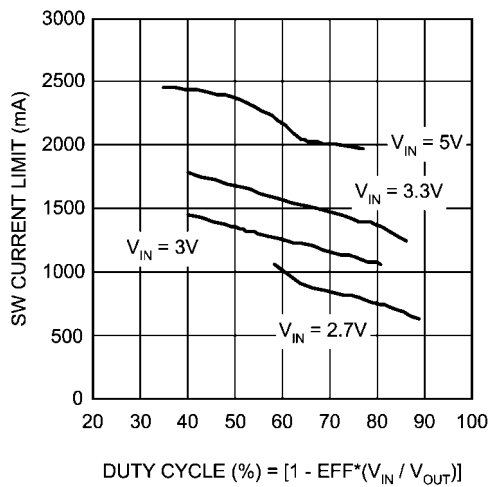

20059151  
**Switch Current Limit vs Duty Cycle - "Y"**

**CALCULATING LOAD CURRENT**

As shown in the figure which depicts inductor current, the load current is related to the average inductor current by the relation:

$$I_{LOAD} = I_{IND}(AVG) \times (1 - DC)$$

Where "DC" is the duty cycle of the application. The switch current can be found by:

$$I_{SW} = I_{IND}(AVG) + \frac{1}{2} (I_{RIPPLE})$$

Inductor ripple current is dependent on inductance, duty cycle, input voltage and frequency:

$$I_{RIPPLE} = DC \times (V_{IN} - V_{SW}) / (f \times L)$$

combining all terms, we can develop an expression which allows the maximum available load current to be calculated:

$$I_{LOAD} (max) = (1 - DC) \times \frac{I_{SW} (max) - DC (V_{IN} - V_{SW})}{2fL}$$

The equation shown to calculate maximum load current takes into account the losses in the inductor or turn-OFF switching losses of the FET and diode. For actual load current in typical applications, we took bench data for various input and output

voltages for both the "X" and "Y" versions of the LM2731 and displayed the maximum load current available for a typical device in graph form:

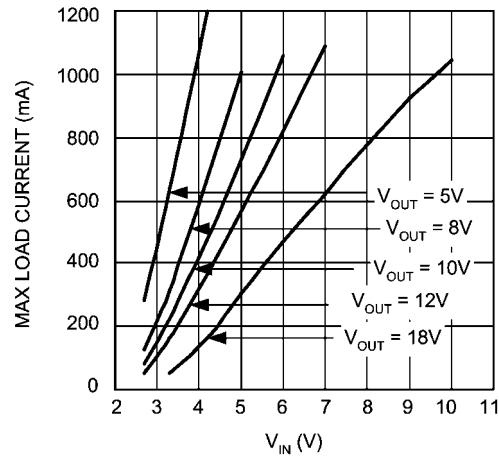

20059148  
**Max. Load Current (typ) vs VIN - "X"**

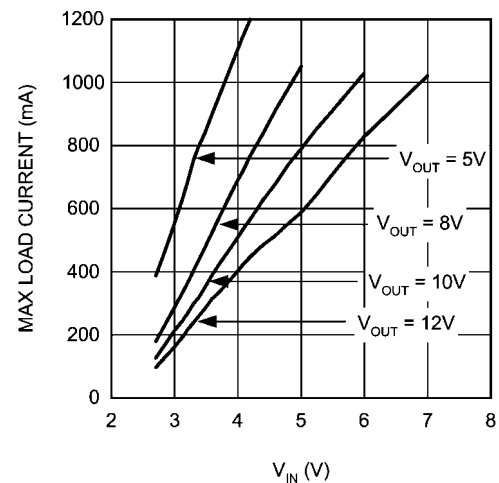

20059149  
**Max. Load Current (typ) vs VIN - "Y"**

**DESIGN PARAMETERS V<sub>SW</sub> AND I<sub>SW</sub>**

The value of the FET "ON" voltage (referred to as V<sub>SW</sub> in the equations) is dependent on load current. A good approximation can be obtained by multiplying the "ON Resistance" of the FET times the average inductor current.

FET on resistance increases at V<sub>IN</sub> values below 5V, since the internal N-FET has less gate voltage in this input voltage range (see Typical performance Characteristics curves). Above V<sub>IN</sub> = 5V, the FET gate voltage is internally clamped to 5V.

The maximum peak switch current the device can deliver is dependent on duty cycle. For higher duty cycles, see Typical performance Characteristics curves.

**THERMAL CONSIDERATIONS**

At higher duty cycles, the increased ON time of the FET means the maximum output current will be determined by power dissipation within the LM2731 FET switch. The switch power dissipation from ON-state conduction is calculated by:

$$P_{(SW)} = DC \times I_{IND}(AVE)^2 \times R_{DS}(ON)$$

There will be some switching losses as well, so some derating needs to be applied when calculating IC power dissipation.

#### INDUCTOR SUPPLIERS

Recommended suppliers of inductors for this product include, but are not limited to Sumida, Coilcraft, Panasonic, TDK and Murata. When selecting an inductor, make certain that the continuous current rating is high enough to avoid saturation at peak currents. A suitable core type must be used to mini-

mize core (switching) losses, and wire power losses must be considered when selecting the current rating.

#### SHUTDOWN PIN OPERATION

The device is turned off by pulling the shutdown pin low. If this function is not going to be used, the pin should be tied directly to  $V_{IN}$ . If the SHDN function will be needed, a pull-up resistor must be used to  $V_{IN}$  (approximately 50k-100k $\Omega$  recommended). The SHDN pin must not be left unterminated.

**Physical Dimensions** inches (millimeters) unless otherwise noted

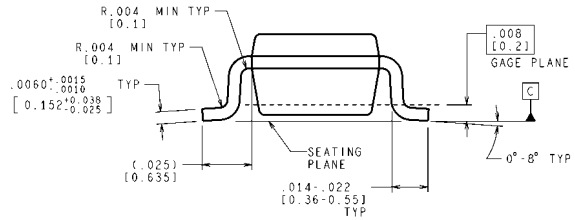
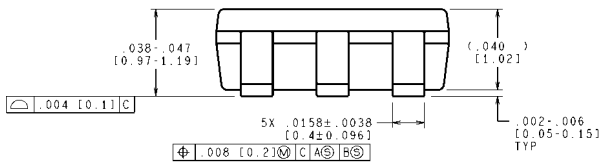
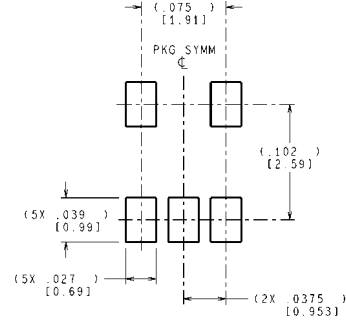
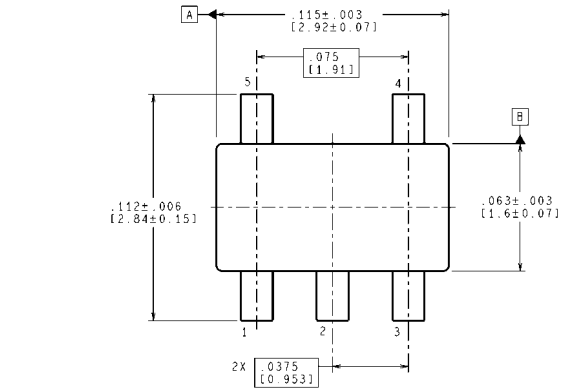

CONTROLLING DIMENSION IS INCH  
 VALUES IN [ ] ARE MILLIMETERS  
 DIMENSIONS IN ( ) FOR REFERENCE ONLY

MF05A (Rev D)

**5-Lead SOT-23 Package**  
**Order Number LM2731XMF, LM2731XMFX, LM2731YMF or LM2731YMFX**  
**NS Package Number MF05A**

## Notes

For more National Semiconductor product information and proven design tools, visit the following Web sites at:  
[www.national.com](http://www.national.com)

Products		Design Support	
Amplifiers	<a href="http://www.national.com/amplifiers">www.national.com/amplifiers</a>	WEBENCH® Tools	<a href="http://www.national.com/webench">www.national.com/webench</a>
Audio	<a href="http://www.national.com/audio">www.national.com/audio</a>	App Notes	<a href="http://www.national.com/appnotes">www.national.com/appnotes</a>
Clock and Timing	<a href="http://www.national.com/timing">www.national.com/timing</a>	Reference Designs	<a href="http://www.national.com/refdesigns">www.national.com/refdesigns</a>
Data Converters	<a href="http://www.national.com/adc">www.national.com/adc</a>	Samples	<a href="http://www.national.com/samples">www.national.com/samples</a>
Interface	<a href="http://www.national.com/interface">www.national.com/interface</a>	Eval Boards	<a href="http://www.national.com/evalboards">www.national.com/evalboards</a>
LVDS	<a href="http://www.national.com/lvds">www.national.com/lvds</a>	Packaging	<a href="http://www.national.com/packaging">www.national.com/packaging</a>
Power Management	<a href="http://www.national.com/power">www.national.com/power</a>	Green Compliance	<a href="http://www.national.com/quality/green">www.national.com/quality/green</a>
Switching Regulators	<a href="http://www.national.com/switchers">www.national.com/switchers</a>	Distributors	<a href="http://www.national.com/contacts">www.national.com/contacts</a>
LDOs	<a href="http://www.national.com/lido">www.national.com/lido</a>	Quality and Reliability	<a href="http://www.national.com/quality">www.national.com/quality</a>
LED Lighting	<a href="http://www.national.com/led">www.national.com/led</a>	Feedback/Support	<a href="http://www.national.com/feedback">www.national.com/feedback</a>
Voltage References	<a href="http://www.national.com/vref">www.national.com/vref</a>	Design Made Easy	<a href="http://www.national.com/easy">www.national.com/easy</a>
PowerWise® Solutions	<a href="http://www.national.com/powerwise">www.national.com/powerwise</a>	Applications & Markets	<a href="http://www.national.com/solutions">www.national.com/solutions</a>
Serial Digital Interface (SDI)	<a href="http://www.national.com/sdi">www.national.com/sdi</a>	Mil/Aero	<a href="http://www.national.com/milaero">www.national.com/milaero</a>
Temperature Sensors	<a href="http://www.national.com/tempensors">www.national.com/tempensors</a>	SolarMagic™	<a href="http://www.national.com/solarmagic">www.national.com/solarmagic</a>
PLL/VCO	<a href="http://www.national.com/wireless">www.national.com/wireless</a>	PowerWise® Design University	<a href="http://www.national.com/training">www.national.com/training</a>

THE CONTENTS OF THIS DOCUMENT ARE PROVIDED IN CONNECTION WITH NATIONAL SEMICONDUCTOR CORPORATION ("NATIONAL") PRODUCTS. NATIONAL MAKES NO REPRESENTATIONS OR WARRANTIES WITH RESPECT TO THE ACCURACY OR COMPLETENESS OF THE CONTENTS OF THIS PUBLICATION AND RESERVES THE RIGHT TO MAKE CHANGES TO SPECIFICATIONS AND PRODUCT DESCRIPTIONS AT ANY TIME WITHOUT NOTICE. NO LICENSE, WHETHER EXPRESS, IMPLIED, ARISING BY ESTOPPEL OR OTHERWISE, TO ANY INTELLECTUAL PROPERTY RIGHTS IS GRANTED BY THIS DOCUMENT.

TESTING AND OTHER QUALITY CONTROLS ARE USED TO THE EXTENT NATIONAL DEEMS NECESSARY TO SUPPORT NATIONAL'S PRODUCT WARRANTY. EXCEPT WHERE MANDATED BY GOVERNMENT REQUIREMENTS, TESTING OF ALL PARAMETERS OF EACH PRODUCT IS NOT NECESSARILY PERFORMED. NATIONAL ASSUMES NO LIABILITY FOR APPLICATIONS ASSISTANCE OR BUYER PRODUCT DESIGN. BUYERS ARE RESPONSIBLE FOR THEIR PRODUCTS AND APPLICATIONS USING NATIONAL COMPONENTS. PRIOR TO USING OR DISTRIBUTING ANY PRODUCTS THAT INCLUDE NATIONAL COMPONENTS, BUYERS SHOULD PROVIDE ADEQUATE DESIGN, TESTING AND OPERATING SAFEGUARDS.

EXCEPT AS PROVIDED IN NATIONAL'S TERMS AND CONDITIONS OF SALE FOR SUCH PRODUCTS, NATIONAL ASSUMES NO LIABILITY WHATSOEVER, AND NATIONAL DISCLAIMS ANY EXPRESS OR IMPLIED WARRANTY RELATING TO THE SALE AND/OR USE OF NATIONAL PRODUCTS INCLUDING LIABILITY OR WARRANTIES RELATING TO FITNESS FOR A PARTICULAR PURPOSE, MERCHANTABILITY, OR INFRINGEMENT OF ANY PATENT, COPYRIGHT OR OTHER INTELLECTUAL PROPERTY RIGHT.

#### LIFE SUPPORT POLICY

**NATIONAL'S PRODUCTS ARE NOT AUTHORIZED FOR USE AS CRITICAL COMPONENTS IN LIFE SUPPORT DEVICES OR SYSTEMS WITHOUT THE EXPRESS PRIOR WRITTEN APPROVAL OF THE CHIEF EXECUTIVE OFFICER AND GENERAL COUNSEL OF NATIONAL SEMICONDUCTOR CORPORATION.** As used herein:

Life support devices or systems are devices which (a) are intended for surgical implant into the body, or (b) support or sustain life and whose failure to perform when properly used in accordance with instructions for use provided in the labeling can be reasonably expected to result in a significant injury to the user. A critical component is any component in a life support device or system whose failure to perform can be reasonably expected to cause the failure of the life support device or system or to affect its safety or effectiveness.

National Semiconductor and the National Semiconductor logo are registered trademarks of National Semiconductor Corporation. All other brand or product names may be trademarks or registered trademarks of their respective holders.

Copyright© 2010 National Semiconductor Corporation

For the most current product information visit us at [www.national.com](http://www.national.com)



**National Semiconductor Americas Technical Support Center**  
 Email: [support@nsc.com](mailto:support@nsc.com)  
 Tel: 1-800-272-9959

**National Semiconductor Europe Technical Support Center**  
 Email: [europe.support@nsc.com](mailto:europe.support@nsc.com)

**National Semiconductor Asia Pacific Technical Support Center**  
 Email: [ap.support@nsc.com](mailto:ap.support@nsc.com)

**National Semiconductor Japan Technical Support Center**  
 Email: [jpn.feedback@nsc.com](mailto:jpn.feedback@nsc.com)