



SERIES: 6 W WALL PLUG - UK BLADE

DESCRIPTION: SWITCHING POWER SUPPLY

FEATURES

- universal AC input
- regulated output voltage
- short circuit, over load protection
- meets EISA / efficiency level V regulations
- custom designs available



MODEL	output voltage		output current		output wattage	ripple*	efficiency level	cord length (mm)
	nominal (V dc)		min (A)	max (A)	max (W)	max. (mVp-p)		
EPSA050120UB	5		0	1.2	6	50	V	1500 +50/-30
EPSA120050UB	12		0	0.5	6	120	V	1500 +50/-30

*100 ~ 240 V ac input, measured at 20MHz bandwidth with a 10 µF electrolytic cap and a 0.1 µF ceramic cap on the output

PART NUMBER KEY

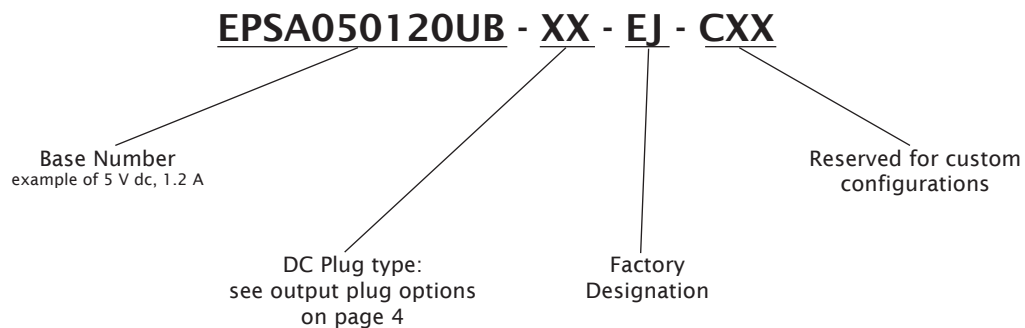



SERIES: 6 W WALL PLUG - UK BLADE

DESCRIPTION: SWITCHING POWER SUPPLY

INPUT

parameter	conditions/description	min	nom	max	units
rated input voltage		100		240	V ac
input voltage range		90		264	V ac
rated frequency		50		60	Hz
frequency range		47		63	Hz
rated input current				0.18	A

OUTPUT

parameter	conditions/description	min	nom	max	units
line regulation			±5		%
load regulation			±5		%
over voltage protection	output shut down				
over current protection				200	%
short circuit protection	yes				
turn-on				2	s
hold-up	110 V ac, 50 Hz, 80% max. load	10			ms

SAFETY & EMI

parameter	conditions/description	min	nom	max	units
HI-POT	input to output at 10 mA for 2 seconds			3,000	V ac
insulation resistance	input to output at 500 V dc	10			MΩ
safety approvals	TUV-BS, CE				
EMI standard	CISPR22 (EN55022) class B				
leakage current				0.25	mA
RoHS compliant	yes				

ENVIRONMENTAL

parameter	conditions/description	min	nom	max	units
operating temperature		0		40	°C
operating humidity		10		95	%
storage temperature		-25		85	°C
storage humidity		10		95	%

RELIABILITY

parameter	conditions/description	min	nom	max	units
MTBF	at full load, 25 °C, Telcordia SR-332, Issue 2			300,000	hours
burn-in	100% burn-in at 40°C ±5°C, 80~100% of full load				



SERIES: 6 W WALL PLUG - UK BLADE

DESCRIPTION: SWITCHING POWER SUPPLY

MECHANICAL DRAWING

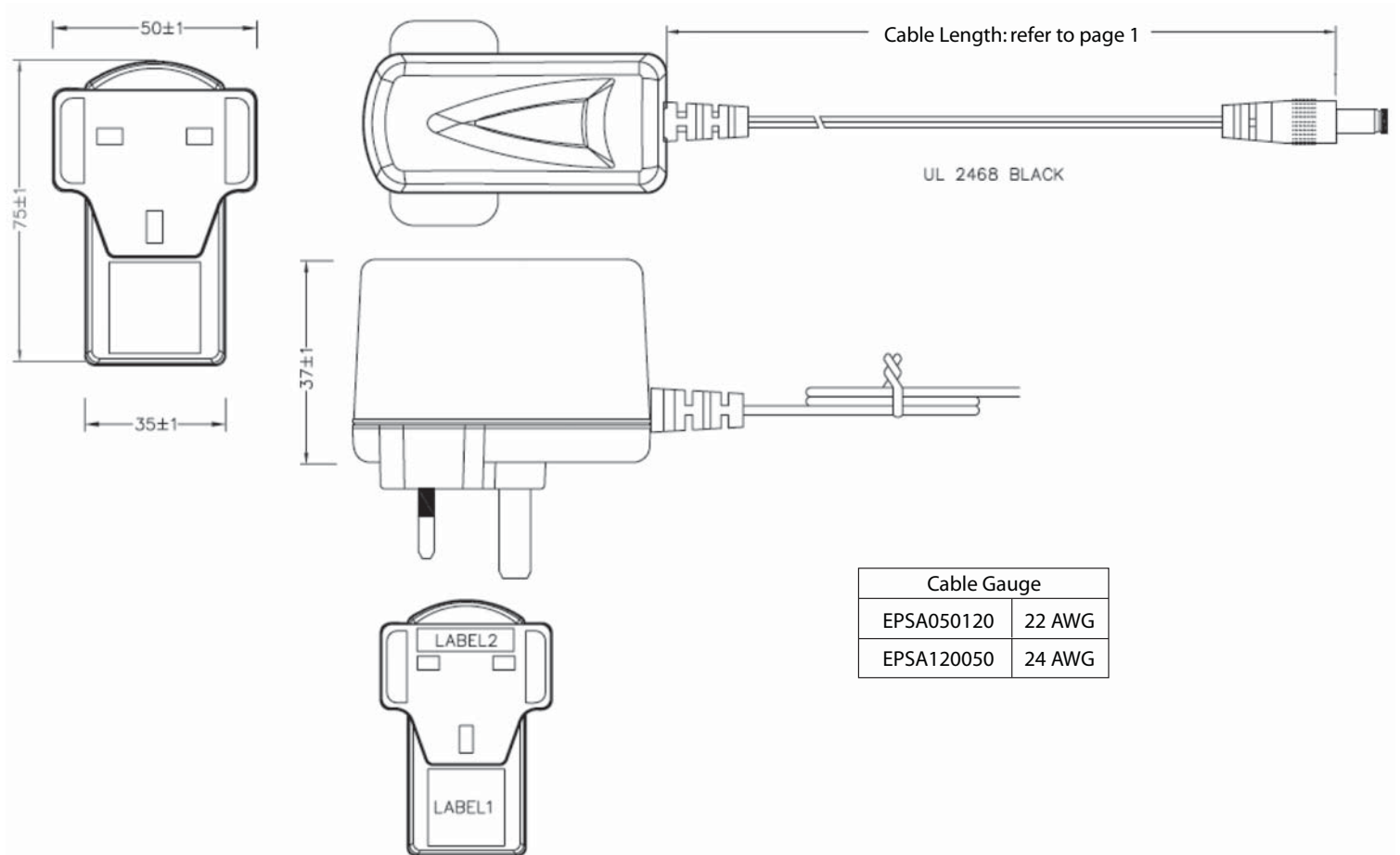



SERIES: 6 W WALL PLUG - UK BLADE

DESCRIPTION: SWITCHING POWER SUPPLY

OUTPUT PLUG OPTIONS

3.5 mm Phono Plug

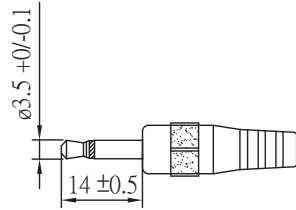

P1

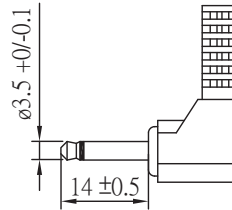

P1R

Standard DC Plug

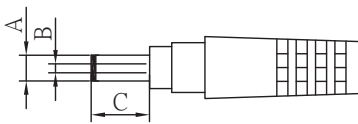

Standard PX

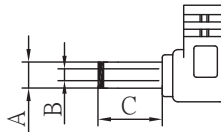

Right Angle PXR

	A	B	C	Unit
P5/P5R	5.5	2.1	9.5	mm
P6/P6R	5.5	2.5	9.5	mm
P7/P7R	3.5	1.3	9.5	mm
P8/P8R	3.8	1.35	9.5	mm
P9/P9R	3.8	1.05	9.5	mm

Locking DC Plug

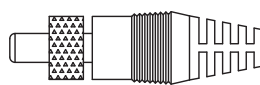
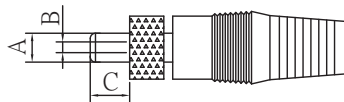

	A	B	C	Unit
P10	5.5	2.1	9.5	mm
P11	5.5	2.5	9.5	mm

EIAJ Plugs

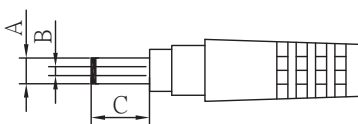

Standard PXX

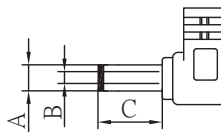

Right Angle PXXR

	EIAJ	A	B	C	Unit
P12/P12R	EIAJ-1	2.35	0.7	9.5	mm
P13/P13R	EIAJ-2	4.0	1.7	9.5	mm
P14/P14R	EIAJ-3	4.75	1.7	9.5	mm

Stripped and Tinned

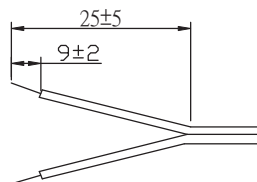

DC PLUG TYPE

ST

stripped and tinned

PXX X X

Plug type

Plug angle:
"blank" = standard
R = right angle

Plug polarity:
"blank" = N/A

P = center positive

N = center negative



*Contact CUI for additional output plug options.