

## Bulk Metal® Foil Technology Ultra High Precision Trimming Potentiometers, 1/4" Square, RJ26 Style, Designed to Meet or Exceed The Requirements of MIL-PRF-39035, Char. H with a Smooth and Unidirectional Output



### INTRODUCTION

Vishay Foil precision trimmers have the Bulk Metal® Foil resistive element which possesses a unique inherent temperature and load life stability. Plus, their advanced virtually back lash-free adjustment mechanism makes them easy to set quickly and accurately and keeps the setting exactly on target.

### FEATURES

- Temperature coefficient of resistance (TCR):  $\pm 10$  ppm/°C. (- 55 °C to + 150 °C ref. at + 25 °C); through the wiper <sup>(3)</sup>;  $\pm 25$  ppm/°C (see table 2 for low values)
- A smooth and unidirectional resistance with leadscrew adjustment
- Load life stability: 0.1 % typical  $\Delta R$ , 1.0 % maximum  $\Delta R$  under full rated power at + 85 °C for 10 000 h
- Settability: 0.05 % typical; 0.1 % maximum
- Setting stability: 0.1 % typical; 0.5 % maximum, DSS
- Power rating: 0.25 W at + 85 °C
- Resistance range: 5  $\Omega$  to 10 k $\Omega$
- Tolerance:  $\pm 5$  %,  $\pm 10$  %
- Electrostatic discharge (ESD) up to 25 000 V
- Terminal finish: gold plated (tin/lead finish is available on request)



RoHS  
COMPLIANT

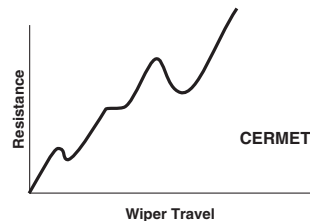
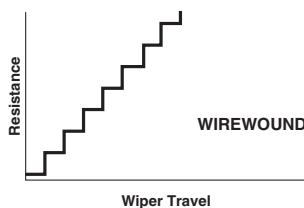
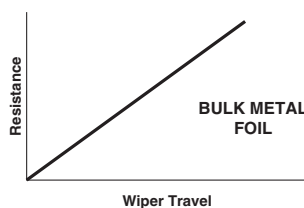

| TABLE 1 - MODEL SELECTION |                                 |                    |                                 |              |
|---------------------------|---------------------------------|--------------------|---------------------------------|--------------|
| MODEL                     | TERMINATION STYLE               | AVERAGE WEIGHT (g) | POWER RATING at + 85 °C AMBIENT | NO. OF TURNS |
| 1240                      | W-edge mount, top adjust        | 0.4                | 0.25 W                          | 21 $\pm$ 2   |
|                           | X-edge mount, side adjust       |                    |                                 |              |
|                           | P-horizontal mount, side adjust |                    |                                 |              |

#### Note

- See Figure 1, next page

| TABLE 2 - 1240 (RJ26) SERIES ELECTRICAL SPECIFICATIONS   |  |
|--|--|
| Temperature Coefficient of Resistance (TCR) 50 $\Omega$ to 10 k $\Omega$ End-to-end <sup>(2)</sup> | $\pm 10$ ppm/°C maximum (- 55 °C to + 150 °C, + 25 °C ref.)  |
| Temperature Coefficient of Resistance 5, 10 and 20 $\Omega$ Through the wiper <sup>(3)</sup>       | $\pm 20$ ppm/°C<br>$\pm 25$ ppm/°C   |
| Stability Load life at 10 000 h End-to-end <sup>(2)</sup>  | 0.1 % typical $\Delta R$<br>1.0 % maximum $\Delta R$ (under full rated power of 0.25 W at + 85 °C) |
| Power Rating <sup>(4)</sup>  | 0.25 W at + 85 °C  |
| Settability  | 0.05 % typical;<br>0.1 % maximum   |
| Setting Stability  | 0.1 % typical;<br>0.5 % maximum  |
| Contact Resistance Variation - CRV (noise) <sup>(5)</sup>  | 3 $\Omega$ typical;<br>10 $\Omega$ maximum   |
| Hop-off  | 0.25 % typical;<br>1.0 % maximum   |
| High-Frequency Operation Rise time Inductance Capacitance  | 1.0 ns without ringing<br>0.08 $\mu$ H typical<br>0.5 pF typical                                   |
| Operating Temperature Range  | - 55 °C to + 150 °C  |

| TABLE 3 - VALUES VS. TOLERANCES           |                    |
|---|--------------------|
| STANDARD RESISTANCE VALUES (in $\Omega$ ) | STANDARD TOLERANCE |
| 5, 10                                     | $\pm 10$ %         |
| 20, 50, 100, 200, 500, 1K, 2K, 5K, 10K    | $\pm 5$ %          |

| TABLE 4 - MECHANICAL SPECIFICATIONS |  |
|-------------------------------------|--|
| Adjustment Turns                    | 21 $\pm$ 2   |
| Mechanical Stops                    | Wiper idles - no discontinuity   |
| Internal Terminations               | All welded - no flux   |
| Case Material                       | 1240X - diallyl-phthalate: green (DAP)<br>1240W - diallyl-phthalate: green (DAP)<br>1240P - thermoplastic: black |
| Shaft Torque                        | 3 oz. in. maximum  |
| Backlash                            | 0.005 % typical  |

**FIGURE 1 - SCHEMATIC AND DIMENSIONS** in Inches (Millimeters)

### 1240X

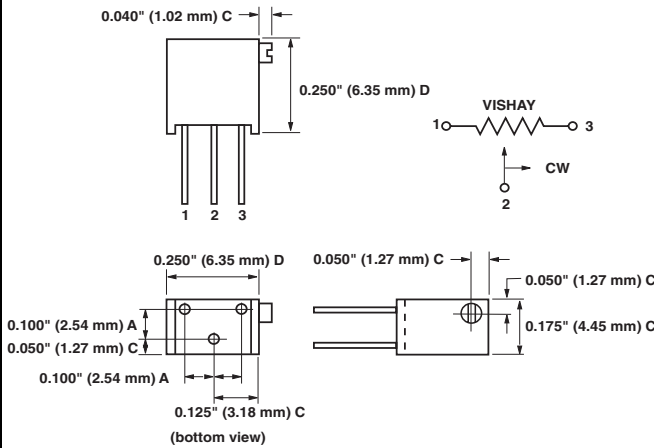

### 1240W



### 1240P



**TOLERANCES:**

- A = ± 0.005" (0.13 mm)
- C = ± 0.010" (0.25 mm)
- D = ± 0.020" (0.51 mm)

**STANDARD MARKING:**

- Model No.
- Date Code
- Resistance Value
- Tolerance

**NOTES:**

Adjustment screw 0.080" (2.03 mm) diameter with 0.025" (0.64 mm) X 0.030" (0.76 mm) slot. Tolerance on screw dimensions is ± 0.005" (0.13 mm). Model 1240 has gold plated terminal pins 0.016" (0.41 mm) ± 0.001" (0.03 mm) diameter, 0.200" (5.08 mm) length minimum.

**FIGURE 2 - POWER DERATING CURVE**

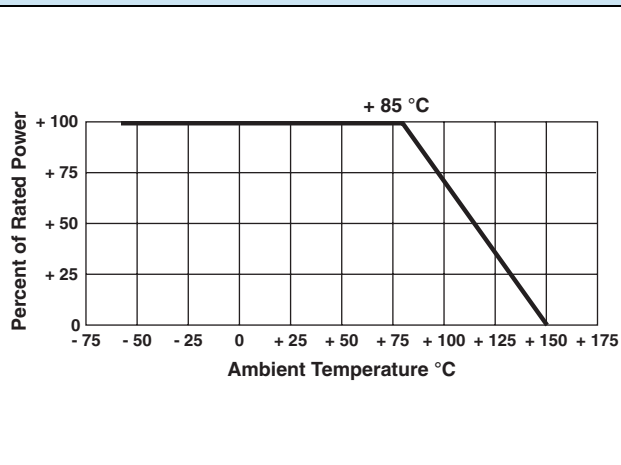

**FIGURE 3 - 1240W 10 kΩ LOAD LIFE, 20 UNITS, 10 000 h at 0.25 W, + 85 °C (Wiper at CW)**

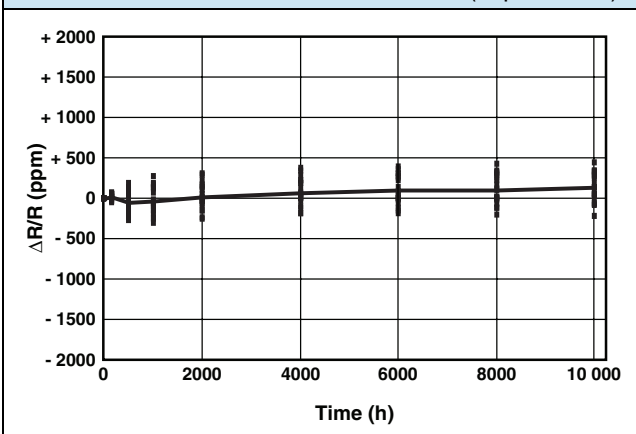

**TABLE 5 - COMPARISON**

|   | MIL-PRF-39035/3 CHARACTERISTIC H <sup>(6)</sup>  | MODEL 1240 MAXIMUM  |
|---|--|---|
| <b>TEST GROUP I</b><br>Conditioning<br>Contact resistance variation - CRV (noise)<br>Immersion  | ± 1.0 %<br>± 3.0 % or 3 Ω <sup>(7)</sup><br>No continuous stream of bubbles  | ± 0.5 %<br>3 Ω typical, 10 Ω maximum<br>No continuous stream of bubbles   |
| <b>TEST GROUP I a</b><br>Visual and mechanical<br>Actual effective electrical travel<br>End resistance<br><br>Dielectric withstanding voltage - DWV<br>Per MIL-STD-202, methods 301 and 105<br>Atmospheric pressure<br>Barometric pressure<br>Insulation resistance<br>Shaft torque<br>Thermal shock<br>Setting stability | No failures<br>10 to 25 turns<br>2 % or 2 Ω <sup>(7)</sup><br><br>600 V <sub>AC</sub> , 1 min<br>250 V <sub>AC</sub> , 1 min<br>≥ 1000 MΩ<br>3 oz. in. maximum<br>± 1.0 %<br>± 1.0 % | No failures<br>21 ± 2 turns<br>2 Ω for values ≤ 1 kΩ;<br>5 Ω for values ≥ 2 kΩ;<br><br>600 V <sub>AC</sub> , 1 min<br>250 V <sub>AC</sub> , 1 min<br>> 1000 MΩ<br>3 oz. in. maximum<br>± 0.5 %<br>± 0.5 % |
| <b>TEST GROUP II</b><br>Solderability   | Per MIL-STD-202, method 208  | Per MIL-STD-202, method 208   |
| <b>TEST GROUP III</b><br>Resistance temperature characteristic - TCR<br>Moisture resistance<br>Contact resistance variation - CRV (noise)   | ± 0.005 %/°C (± 50 ppm/°C)<br>± 1.0 %<br>3.0 % or 3 Ω <sup>(7)</sup>   | ± 0.001 %/°C (± 10 ppm/°C)<br>± 0.5 %<br>3 Ω typical, 10 Ω maximum  |
| <b>TEST GROUP IV</b><br>Settability<br>Shock<br>Setting stability<br>Vibration<br>Setting stability<br>Contact resistance variation - CRV (noise)<br>Salt spray   | ± 1.0 %<br>± 1.0 %<br>± 1.0 %<br>± 1.0 %<br>± 1.0 %<br>3.0 % or 3 Ω <sup>(7)</sup><br>No corrosion   | ± 0.1 %<br>± 0.5 %<br>± 0.5 %<br>± 0.5 %<br>± 0.5 %<br>3 Ω typical, 10 Ω maximum<br>No corrosion  |
| <b>TEST GROUP V</b><br>Solder heat<br>Low-temperature operation<br>Setting stability<br>Low-temperature storage<br>High-temperature exposure<br>Setting stability<br>Contact resistance variation - CRV (noise)<br>Integrity of shaft   | ± 1.0 %<br>± 1.0 %<br>± 2.0 %<br>± 1.0 %<br>± 3.0 %<br>± 2.0 %<br>3 % or 3 Ω <sup>(7)</sup><br>No loosening or breakage  | ± 0.1 %<br>± 0.5 %<br>± 0.5 %<br>± 0.5 %<br>± 0.5 %<br>± 0.5 %<br>3 Ω typical, 10 Ω maximum<br>No loosening or breakage   |
| <b>TEST GROUP VI</b><br>Rotational life (200 cycles)<br>Contact resistance variation - CRV (noise)<br>Terminal strength   | ± 2.0 %<br>3 % or 3 Ω <sup>(7)</sup><br>2 lbs.   | ± 2.0 %<br>3 Ω typical, 10 Ω maximum<br>2 lbs.  |
| <b>TEST GROUP VII</b><br>Life (2000 h) at + 85 °C<br>Life (10 000 h) at + 85 °C   | ± 3.0 %<br>± 5.0 %   | ± 0.1 % typical, ± 1.0 % maximum<br>± 0.1 % typical, ± 1.0 % maximum  |
| <b>TEST GROUP VIII</b><br>Solvent resistance  | No failures  | No failures   |

**Notes**

- (1) Maximum is 1.0 % A.Q.L. standard for all specifications except TCR. (For TCR information, see notes 2 and 3.)
- (2) Maximum TCR applies to the 3 σ (sigma) limit or 99.73 % of a production lot. (Measured end-to-end with wiper off the element.)
- (3) Measurements of TCR through the wiper are influenced more by setting stability and the percentage of the total resistance in use (at the wiper) than by fundamental resistance change due to temperature alone. The parameter shown in table 2 is a 2 s distribution typifying the behavior of the device when used with 40 % or more of the total resistance in use.
- (4) Derated linearly for full power at + 85 °C to zero power at + 150 °C. See Figure 2 on previous page.
- (5) Independent of resistance value. 3 Ω maximum available on special request.
- (6) All ΔR's are measured to the tolerance specified + 0.01 Ω.
- (7) Whichever is greater.  
Special Available Options:  
Special marking  
Burn-in and screening operations.

**VISHAY TRIMMERS ARE INSPECTED**

- 100 % for:
- Immersion
  - Resistance tolerance check
  - End resistance
  - Visual-mechanical
  - Dynamic tests for continuity, CRV
- By sample for:
- TCR
  - DWV

**TABLE 6 - GLOBAL PART NUMBER INFORMATION**

NEW GLOBAL PART NUMBER: Y4053500R000J0L (preferred part number format)

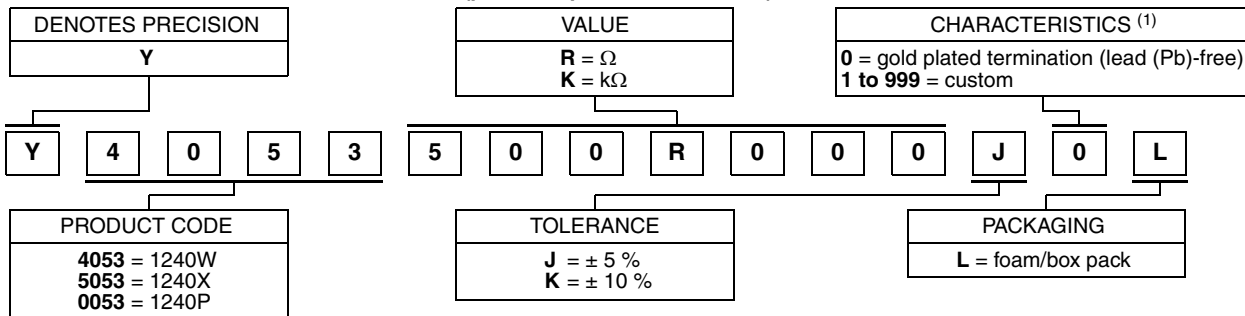

FOR EXAMPLE: ABOVE GLOBAL ORDER Y4053 500R000 J 0 L:

TYPE: 1240W

VALUE: 500.0 Ω

ABSOLUTE TOLERANCE: ± 5.0 %

TERMINATION: gold plated termination (lead (Pb)-free)

PACKAGING: foam/box pack

HISTORICAL PART NUMBER: 1240W 500R00 J B (will continue to be used)



**Note**

<sup>(1)</sup> For non-standard requests, please contact application engineering.

## Disclaimer

All product specifications and data are subject to change without notice.

Vishay Precision Group, Inc., its affiliates, agents, and employees, and all persons acting on its or their behalf (collectively, "Vishay Precision Group"), disclaim any and all liability for any errors, inaccuracies or incompleteness contained herein or in any other disclosure relating to any product.

Vishay Precision Group disclaims any and all liability arising out of the use or application of any product described herein or of any information provided herein to the maximum extent permitted by law. The product specifications do not expand or otherwise modify Vishay Precision Group's terms and conditions of purchase, including but not limited to the warranty expressed therein, which apply to these products.

No license, express or implied, by estoppel or otherwise, to any intellectual property rights is granted by this document or by any conduct of Vishay Precision Group.

The products shown herein are not designed for use in medical, life-saving, or life-sustaining applications unless otherwise expressly indicated. Customers using or selling Vishay Precision Group products not expressly indicated for use in such applications do so entirely at their own risk and agree to fully indemnify Vishay Precision Group for any damages arising or resulting from such use or sale. Please contact authorized Vishay Precision Group personnel to obtain written terms and conditions regarding products designed for such applications.

Product names and markings noted herein may be trademarks of their respective owners.