

### FEATURES

Fixed (ADP322) and adjustable (ADP323) options

Bias voltage range (VBIAS): 2.5 V to 5.5 V

LDO input voltage range (VIN1/VIN2, VIN3): 1.8 V to 5.5 V

Three 200 mA low dropout voltage regulators (LDOs)

16-lead, 3 mm × 3 mm LFCSP

Initial accuracy: ±1%

Stable with 1 μF ceramic output capacitors

No noise bypass capacitor required

3 independent logic controlled enables

Overcurrent and thermal protection

Key specifications

High PSRR

76 dB PSRR up to 1 kHz

70 dB PSRR at 10 kHz

60 dB PSRR at 100 kHz

40 dB PSRR at 1 MHz

Low output noise

29 μV rms typical output noise at V<sub>OUT</sub> = 1.2 V

55 μV rms typical output noise at V<sub>OUT</sub> = 2.8 V

Excellent transient response

Low dropout voltage: 110 mV at 200 mA load

85 μA typical ground current at no load, all LDOs enabled

100 μs fast turn-on circuit

Guaranteed 200 mA output current per regulator

–40°C to +125°C junction temperature

### APPLICATIONS

Mobile phones

Digital cameras and audio devices

Portable and battery-powered equipment

Portable medical devices

Post dc-to-dc regulation

### GENERAL DESCRIPTION

The ADP322/ADP323 200 mA triple output LDOs combine high PSRR, low noise, low quiescent current, and low dropout voltage to extend the battery life of portable devices and are ideally suited for wireless applications with demanding performance and board space requirements.

The ADP322/ADP323 PSRR is greater than 60 dB for frequencies as high as 100 kHz while operating with a low headroom voltage.

The ADP322/ADP323 offer much lower noise performance than competing LDOs without the need for a noise bypass capacitor.

#### Rev. 0

Information furnished by Analog Devices is believed to be accurate and reliable. However, no responsibility is assumed by Analog Devices for its use, nor for any infringements of patents or other rights of third parties that may result from its use. Specifications subject to change without notice. No license is granted by implication or otherwise under any patent or patent rights of Analog Devices. Trademarks and registered trademarks are the property of their respective owners.

### TYPICAL APPLICATION CIRCUITS

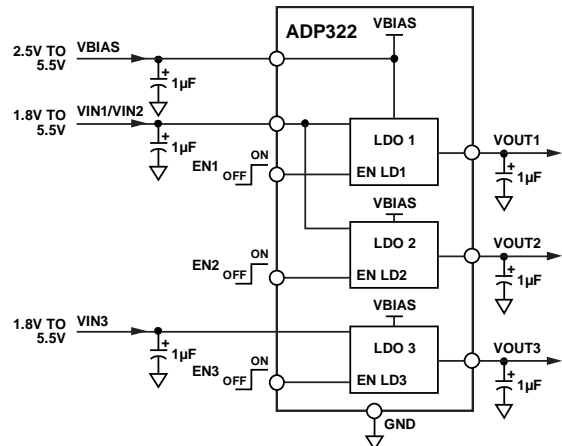

Figure 1. Typical Application Circuit for ADP322

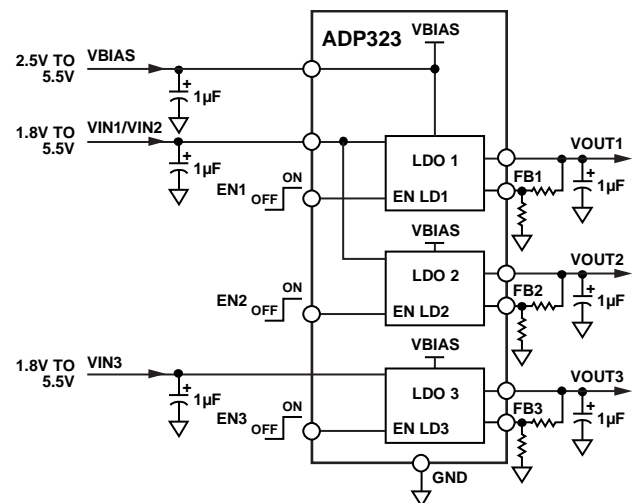

Figure 2. Typical Application Circuit for ADP323

The ADP322/ADP323 are available in a miniature 16-lead, 3 mm × 3 mm LFCSP package and are stable with tiny 1 μF ±30% ceramic output capacitors providing the smallest possible board area for a wide variety of portable power needs.

The ADP322 is available in output voltage combinations ranging from 0.8 V to 3.3 V and offers overcurrent and thermal protection to prevent damage in adverse conditions. The APDP323 adjustable triple LDO can be configured for any output voltage between 0.5 V and 5 V with two resistors for each output.

## TABLE OF CONTENTS

Features .....	1	Theory of Operation .....	15
Applications.....	1	Applications Information .....	16
Typical Application Circuits.....	1	Capacitor Selection .....	16
General Description .....	1	Undervoltage Lockout .....	17
Revision History .....	2	Enable Feature .....	17
Specifications.....	3	Current-Limit and Thermal Overload Protection.....	18
Input and Output Capacitor, Recommended Specifications..	4	Thermal Considerations.....	18
Absolute Maximum Ratings.....	5	Printed Circuit Board Layout Considerations.....	20
Thermal Resistance .....	5	Outline Dimensions .....	21
ESD Caution.....	5	Ordering Guide .....	21
Pin Configurations and Function Descriptions .....	6		
Typical Performance Characteristics .....	8		

## REVISION HISTORY

9/10—Revision 0: Initial Version

## SPECIFICATIONS

$V_{IN1}/V_{IN2} = V_{IN3} = (V_{OUT} + 0.5 \text{ V})$  or 1.8 V (whichever is greater),  $V_{BIAS} = 2.5 \text{ V}$ ,  $EN1, EN2, EN3 = V_{BIAS}$ ,  $I_{OUT1} = I_{OUT2} = I_{OUT3} = 10 \text{ mA}$ ,  $C_{IN} = C_{OUT1} = C_{OUT2} = C_{OUT3} = 1 \mu\text{F}$ , and  $T_A = 25^\circ\text{C}$ , unless otherwise noted.

Table 1.

Parameter	Symbol	Conditions	Min	Typ	Max	Unit
VOLTAGE RANGE						
Input Bias Voltage Range	$V_{BIAS}$	$T_J = -40^\circ\text{C}$ to $+125^\circ\text{C}$	2.5		5.5	V
Input LDO Voltage Range	$V_{IN1}/V_{IN2}/V_{IN3}$	$T_J = -40^\circ\text{C}$ to $+125^\circ\text{C}$	1.8		5.5	V
CURRENT						
Ground Current with All Regulators On	$I_{GND}$	$I_{OUT} = 0 \mu\text{A}$		85		$\mu\text{A}$
		$I_{OUT} = 0 \mu\text{A}, T_J = -40^\circ\text{C}$ to $+125^\circ\text{C}$			160	$\mu\text{A}$
		$I_{OUT} = 10 \text{ mA}$		120		$\mu\text{A}$
		$I_{OUT} = 10 \text{ mA}, T_J = -40^\circ\text{C}$ to $+125^\circ\text{C}$			220	$\mu\text{A}$
		$I_{OUT} = 200 \text{ mA}$		250		$\mu\text{A}$
		$I_{OUT} = 200 \text{ mA}, T_J = -40^\circ\text{C}$ to $+125^\circ\text{C}$			380	$\mu\text{A}$
Bias Voltage Input Current	$I_{BIAS}$			66		$\mu\text{A}$
Shutdown Current	$I_{GND-SD}$	$T_J = -40^\circ\text{C}$ to $+125^\circ\text{C}$ $EN1 = EN2 = EN3 = GND$		0.1		$\mu\text{A}$
		$EN1 = EN2 = EN3 = GND, T_J = -40^\circ\text{C}$ to $+125^\circ\text{C}$			2.5	$\mu\text{A}$
FEEDBACK INPUT CURRENT	$I_{FBIN}$			0.01		$\mu\text{A}$
VOLTAGE ACCURACY						
Output Voltage Accuracy (ADP322)	$V_{OUT}$		-1		+1	%
		$100 \mu\text{A} < I_{OUT} < 200 \text{ mA}, V_{IN} = (V_{OUT} + 0.5 \text{ V})$ to 5.5 V, $T_J = -40^\circ\text{C}$ to $+125^\circ\text{C}$	-2		+2	%
Feedback Voltage Accuracy (ADP323) <sup>1</sup>	$V_{FB}$		0.495	0.5	0.505	V
		$100 \mu\text{A} < I_{OUT} < 200 \text{ mA}, V_{IN} = (V_{OUT} + 0.5 \text{ V})$ to 5.5 V, $T_J = -40^\circ\text{C}$ to $+125^\circ\text{C}$	0.490		0.510	V
LINE REGULATION						
	$\Delta V_{OUT}/\Delta V_{IN}$	$V_{IN} = (V_{OUT} + 0.5 \text{ V})$ to 5.5 V		0.01		%/V
		$V_{IN} = (V_{OUT} + 0.5 \text{ V})$ to 5.5 V, $T_J = -40^\circ\text{C}$ to $+125^\circ\text{C}$	-0.03		+0.03	%/V
LOAD REGULATION <sup>2</sup>						
	$\Delta V_{OUT}/\Delta I_{OUT}$	$I_{OUT} = 1 \text{ mA}$ to 200 mA		0.001		%/mA
		$I_{OUT} = 1 \text{ mA}$ to 200 mA, $T_J = -40^\circ\text{C}$ to $+125^\circ\text{C}$			0.005	%/mA
DROPOUT VOLTAGE <sup>3</sup>						
	$V_{DROPOUT}$	$V_{OUT} = 3.3 \text{ V}$		6		mV
		$I_{OUT} = 10 \text{ mA}$			9	mV
		$I_{OUT} = 10 \text{ mA}, T_J = -40^\circ\text{C}$ to $+125^\circ\text{C}$				mV
		$I_{OUT} = 200 \text{ mA}$		110		mV
		$I_{OUT} = 200 \text{ mA}, T_J = -40^\circ\text{C}$ to $+125^\circ\text{C}$			170	mV
START-UP TIME <sup>4</sup>						
	$T_{START-UP}$	$V_{OUT} = 3.3 \text{ V}$ , all $V_{OUT}$ initially off, enable any LDO		240		$\mu\text{s}$
		$V_{OUT} = 0.8 \text{ V}$		100		$\mu\text{s}$
		$V_{OUT} = 3.3 \text{ V}$ , one $V_{OUT}$ initially on, enable second or third LDO		160		$\mu\text{s}$
		$V_{OUT} = 0.8 \text{ V}$		20		$\mu\text{s}$
CURRENT LIMIT THRESHOLD <sup>5</sup>	$I_{LIMIT}$		250	360	600	mA
THERMAL SHUTDOWN						
Thermal Shutdown Threshold	$T_{SD}$	$T_J$ rising		155		$^\circ\text{C}$
Thermal Shutdown Hysteresis	$T_{SD-HYS}$			15		$^\circ\text{C}$

# ADP322/ADP323

Parameter	Symbol	Conditions	Min	Typ	Max	Unit
EN INPUT						
EN Input Logic High	$V_{IH}$	$2.5\text{ V} \leq V_{BIAS} \leq 5.5\text{ V}$	1.2			V
EN Input Logic Low	$V_{IL}$	$2.5\text{ V} \leq V_{BIAS} \leq 5.5\text{ V}$			0.4	V
EN Input Leakage Current	$V_{I-LEAKAGE}$	EN1 = EN2 = EN3 = $V_{IN}$ or GND EN1 = EN2 = EN3 = $V_{IN}$ or GND, $T_J = -40^\circ\text{C}$ to $+125^\circ\text{C}$		0.1	1	$\mu\text{A}$ $\mu\text{A}$
UNDERVOLTAGE LOCKOUT						
Input Bias Voltage (VBIAS) Rising	UVLO <sub>RISE</sub>				2.45	V
Input Bias Voltage (VBIAS) Falling	UVLO <sub>FALL</sub>		2.0			V
Hysteresis	UVLO <sub>HYS</sub>			180		mV
OUTPUT NOISE	OUT <sub>NOISE</sub>	10 Hz to 100 kHz, $V_{IN} = 5\text{ V}$ , $V_{OUT} = 3.3\text{ V}$ 10 Hz to 100 kHz, $V_{IN} = 5\text{ V}$ , $V_{OUT} = 2.8\text{ V}$ 10 Hz to 100 kHz, $V_{IN} = 3.6\text{ V}$ , $V_{OUT} = 2.5\text{ V}$ 10 Hz to 100 kHz, $V_{IN} = 3.6\text{ V}$ , $V_{OUT} = 1.2\text{ V}$		63 55 50 29		$\mu\text{V rms}$ $\mu\text{V rms}$ $\mu\text{V rms}$ $\mu\text{V rms}$
POWER SUPPLY REJECTION RATIO	PSRR	$V_{IN} = 1.8\text{ V}$ , $V_{OUT} = 0.8\text{ V}$ , $I_{OUT} = 100\text{ mA}$ 100 Hz 1 kHz 10 kHz 100 kHz 1 MHz $V_{IN} = 3.8\text{ V}$ , $V_{OUT} = 2.8\text{ V}$ , $I_{OUT} = 100\text{ mA}$ 100 Hz 1 kHz 10 kHz 100 kHz 1 MHz		70 70 70 60 40 68 62 68 60 40		dB dB dB dB dB dB dB dB dB dB

<sup>1</sup> Accuracy when VOUTx is connected directly to FBx. When the VOUTx voltage is set by external feedback resistors, the absolute accuracy in adjust mode depends on the tolerances of the resistors used.

<sup>2</sup> Based on an end-point calculation using 1 mA and 200 mA loads.

<sup>3</sup> The dropout voltage specification applies only to output voltages greater than 1.8 V. Dropout voltage is defined as the input-to-output voltage differential when the input voltage is set to the nominal output voltage.

<sup>4</sup> Start-up time is defined as the time between the rising edge of ENx to VOUTx being at 90% of its nominal value.

<sup>5</sup> Current-limit threshold is defined as the current at which the output voltage drops to 90% of the specified typical value. For example, the current limit for a 3.0 V output voltage is defined as the current that causes the output voltage to drop to 90% of 3.0 V, that is, 2.7 V.

## INPUT AND OUTPUT CAPACITOR, RECOMMENDED SPECIFICATIONS

Table 2.

Parameter	Symbol	Conditions	Min	Typ	Max	Unit
MINIMUM INPUT AND OUTPUT CAPACITANCE <sup>1</sup>	$C_{MIN}$	$T_A = -40^\circ\text{C}$ to $+125^\circ\text{C}$	0.70			$\mu\text{F}$
CAPACITOR ESR	$R_{ESR}$	$T_A = -40^\circ\text{C}$ to $+125^\circ\text{C}$	0.001		1	$\Omega$

<sup>1</sup> The minimum input and output capacitance should be greater than 0.70  $\mu\text{F}$  over the full range of operating conditions. The full range of operating conditions in the application must be considered during device selection to ensure that the minimum capacitance specification is met. X7R and X5R type capacitors are recommended; Y5V and Z5U capacitors are not recommended for use with LDOs.

## ABSOLUTE MAXIMUM RATINGS

Table 3.

Parameter	Rating
VIN1/VIN2, VIN3, VBIAS to GND	–0.3 V to +6.5 V
VOUT1, VOUT2, FB1, FB2 to GND	–0.3 V to VIN1/VIN2
VOUT3, FB3 to GND	–0.3 V to VIN3
EN1, EN2, EN3 to GND	–0.3 V to +6.5 V
Storage Temperature Range	–65°C to +150°C
Operating Junction Temperature Range	–40°C to +125°C
Soldering Conditions	JEDEC J-STD-020

Stresses above those listed under absolute maximum ratings may cause permanent damage to the device. This is a stress rating only and functional operation of the device at these or any other conditions above those indicated in the operational section of this specification is not implied. Exposure to absolute maximum rating conditions for extended periods may affect device reliability.

### THERMAL DATA

Absolute maximum ratings apply individually only, not in combination.

The ADP322/ADP323 triple LDO can be damaged when the junction temperature limits are exceeded. Monitoring ambient temperature does not guarantee that the junction temperature ( $T_J$ ) is within the specified temperature limits. In applications with high power dissipation and poor thermal resistance, the maximum ambient temperature may have to be derated. In applications with moderate power dissipation and low PCB thermal resistance, the maximum ambient temperature can exceed the maximum limit as long as the junction temperature is within specification limits.

The junction temperature ( $T_J$ ) of the device is dependent on the ambient temperature ( $T_A$ ), the power dissipation of the device ( $P_D$ ), and the junction-to-ambient thermal resistance of the package ( $\theta_{JA}$ ). Maximum junction temperature ( $T_J$ ) is calculated from the ambient temperature ( $T_A$ ) and power dissipation ( $P_D$ ) using the following formula:

$$T_J = T_A + (P_D \times \theta_{JA})$$

Junction-to-ambient thermal resistance ( $\theta_{JA}$ ) of the package is based on modeling and calculation using a 4-layer board. The junction-to-ambient thermal resistance is highly dependent on the application and board layout. In applications where high maximum power dissipation exists, close attention to thermal board design is required. The value of  $\theta_{JA}$  may vary, depending on PCB material, layout, and environmental conditions. The specified values of  $\theta_{JA}$  are based on a 4-layer, 4 inch  $\times$  3 inch circuit board. See JEDEC JESD 51-9 for detailed information on the board construction. For additional information, see the AN-617 Application Note, *MicroCSP™ Wafer Level Chip Scale Package*.

$\Psi_{JB}$  is the junction to board thermal characterization parameter with units of °C/W.  $\Psi_{JB}$  of the package is based on modeling and calculation using a 4-layer board. The JESD51-12, *Guidelines for Reporting and Using Package Thermal Information*, states that thermal characterization parameters are not the same as thermal resistances.  $\Psi_{JB}$  measures the component power flowing through multiple thermal paths rather than a single path as in thermal resistance,  $\theta_{JB}$ . Therefore,  $\Psi_{JB}$  thermal paths include convection from the top of the package as well as radiation from the package, factors that make  $\Psi_{JB}$  more useful in real-world applications. Maximum junction temperature ( $T_J$ ) is calculated from the board temperature ( $T_B$ ) and power dissipation ( $P_D$ ) using the following formula:

$$T_J = T_B + (P_D \times \Psi_{JB})$$

See JEDEC JESD51-8 and JESD51-12 for more detailed information about  $\Psi_{JB}$ .

### THERMAL RESISTANCE

$\theta_{JA}$  and  $\Psi_{JB}$  are specified for the worst-case conditions, that is, a device soldered in a circuit board for surface-mount packages.

Table 4.

Package Type	$\theta_{JA}$	$\Psi_{JB}$	Unit
16-Lead, 3 mm $\times$ 3 mm LFCSP	49.5	25.2	°C/W

### ESD CAUTION



**ESD (electrostatic discharge) sensitive device.** Charged devices and circuit boards can discharge without detection. Although this product features patented or proprietary protection circuitry, damage may occur on devices subjected to high energy ESD. Therefore, proper ESD precautions should be taken to avoid performance degradation or loss of functionality.

## PIN CONFIGURATIONS AND FUNCTION DESCRIPTIONS

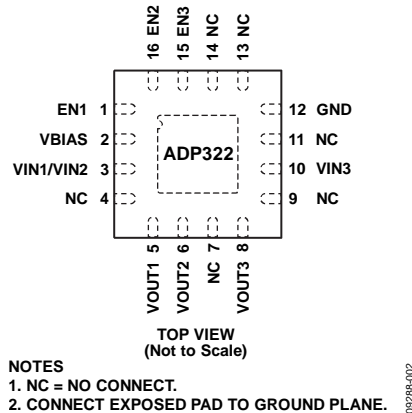
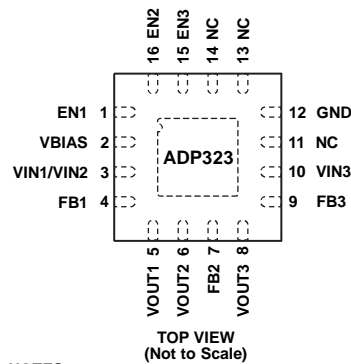

Figure 3. ADP322 Pin Configuration

Table 5. ADP322 Pin Function Descriptions

Pin No.	Mnemonic	Description
1	EN1	Enable Input for Regulator 1. Drive EN1 high to turn on Regulator 1; drive it low to turn off Regulator 1. For automatic startup, connect EN1 to VBIAS.
2	VBIAS	Input Voltage Bias Supply. Bypass VBIAS to GND with a 1 $\mu$ F or greater capacitor.
3	VIN1/VIN2	Regulator Input Supply for Output Voltage 1 and Output Voltage 2. Bypass VIN1/VIN2 to GND with a 1 $\mu$ F or greater capacitor.
4	NC	Not connected internally.
5	VOUT1	Regulated Output Voltage 1. Connect a 1 $\mu$ F or greater output capacitor between VOUT1 and GND.
6	VOUT2	Regulated Output Voltage 2. Connect a 1 $\mu$ F or greater output capacitor between VOUT2 and GND.
7	NC	Not connected internally.
8	VOUT3	Regulated Output Voltage 3. Connect a 1 $\mu$ F or greater output capacitor between VOUT3 and GND.
9	NC	Not connected internally.
10	VIN3	Regulator Input Supply for Output Voltage 3. Bypass VIN3 to GND with a 1 $\mu$ F or greater capacitor.
11	NC	Not connected internally.
12	GND	Ground Pin.
13	NC	Not connected internally.
14	NC	Not connected internally.
15	EN3	Enable Input for Regulator 3. Drive EN3 high to turn on Regulator 3; drive it low to turn off Regulator 3. For automatic startup, connect EN3 to VBIAS.
16	EN2	Enable Input for Regulator 2. Drive EN2 high to turn on Regulator 2; drive it low to turn off Regulator 2. For automatic startup, connect EN2 to VBIAS.
	EP	Exposed pad for enhanced thermal performance. Connect to copper ground plane.



## NOTES

1. NC = NO CONNECT.
2. CONNECT EXPOSED PAD TO GROUND PLANE.

092288-054

Figure 4. ADP323 Pin Configuration

Table 6. ADP323 Pin Function Descriptions

Pin No.	Mnemonic	Description
1	EN1	Enable Input for Regulator 1. Drive EN1 high to turn on Regulator 1; drive it low to turn off Regulator 1. For automatic startup, connect EN1 to VBIAS.
2	VBIAS	Input Voltage Bias Supply. Bypass VBIAS to GND with a 1 $\mu$ F or greater capacitor.
3	VIN1/VIN2	Regulator Input Supply for Output Voltage 1 and Output Voltage 2. Bypass VIN1/VIN2 to GND with a 1 $\mu$ F or greater capacitor.
4	FB1	Connect the midpoint of the voltage divider from VOUT1 to GND to set VOUT1.
5	VOUT1	Regulated Output Voltage 1. Connect a 1 $\mu$ F or greater output capacitor between VOUT1 and GND.
6	VOUT2	Regulated Output Voltage 2. Connect a 1 $\mu$ F or greater output capacitor between VOUT2 and GND.
7	FB2	Connect the midpoint of the voltage divider from VOUT2 to GND to set VOUT2.
8	VOUT3	Regulated Output Voltage 3. Connect a 1 $\mu$ F or greater output capacitor between VOUT3 and GND.
9	FB3	Connect the midpoint of the voltage divider from VOUT3 to GND to set VOUT3.
10	VIN3	Regulator Input Supply for Output Voltage 3. Bypass VIN3 to GND with a 1 $\mu$ F or greater capacitor.
11	NC	Not connected internally.
12	GND	Ground Pin.
13	NC	Not connected internally.
14	NC	Not connected internally.
15	EN3	Enable Input for Regulator 3. Drive EN3 high to turn on Regulator 3; drive it low to turn off Regulator 3. For automatic startup, connect EN3 to VBIAS.
16	EN2	Enable Input for Regulator 2. Drive EN3 high to turn on Regulator 2; drive it low to turn off Regulator 2. For automatic startup, connect EN2 to VBIAS.
	EP	Exposed pad for enhanced thermal performance. Connect to copper ground plane.

## TYPICAL PERFORMANCE CHARACTERISTICS

$V_{IN1}/V_{IN2} = V_{IN3} = V_{BIAS} = 4\text{ V}$ ,  $V_{OUT1} = 3.3\text{ V}$ ,  $V_{OUT2} = 1.8\text{ V}$ ,  $V_{OUT3} = 1.5\text{ V}$ ,  $I_{OUT} = 10\text{ mA}$ ,  $C_{IN} = C_{OUT1} = C_{OUT2} = C_{OUT3} = 1\text{ }\mu\text{F}$ ,  $V_{ENX}$  is the enable voltage,  $T_A = 25^\circ\text{C}$ , unless otherwise noted.

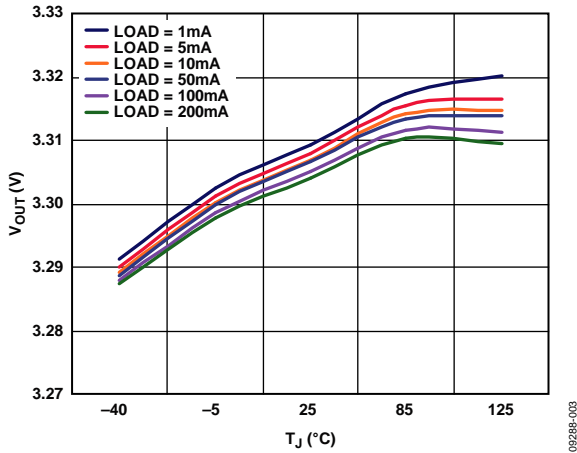

Figure 5. Output Voltage vs. Junction Temperature

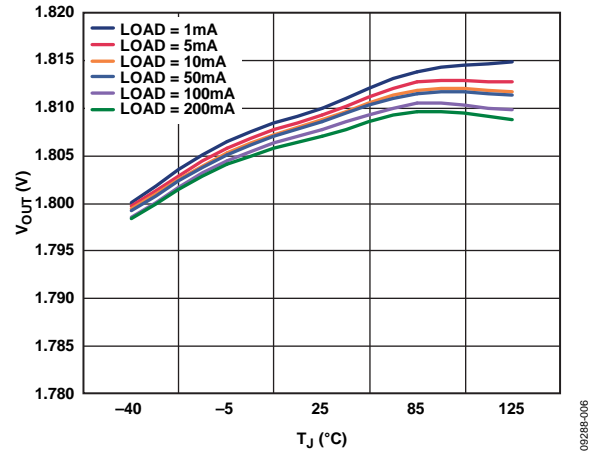

Figure 8. Output Voltage vs. Junction Temperature

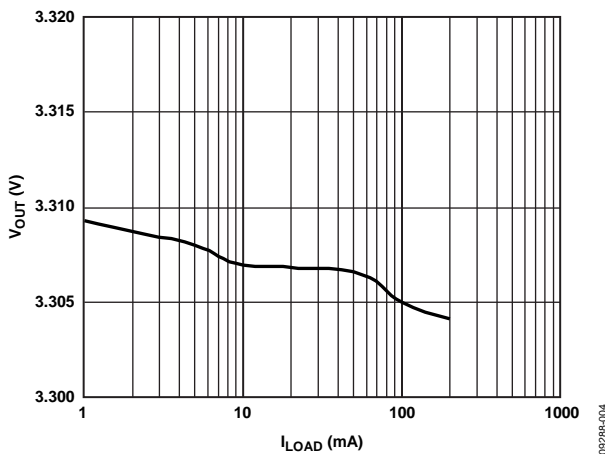

Figure 6. Output Voltage vs. Load Current

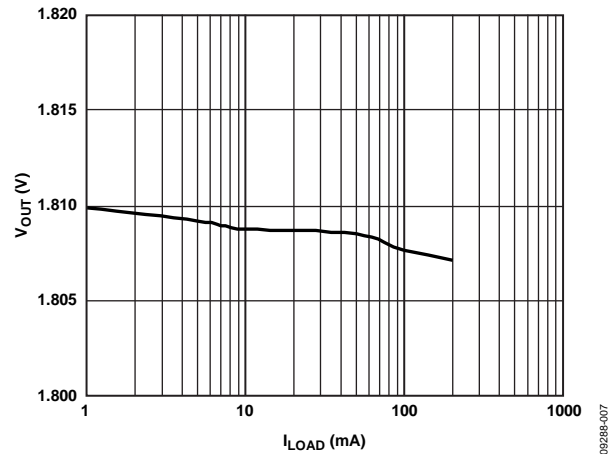

Figure 9. Output Voltage vs. Load Current

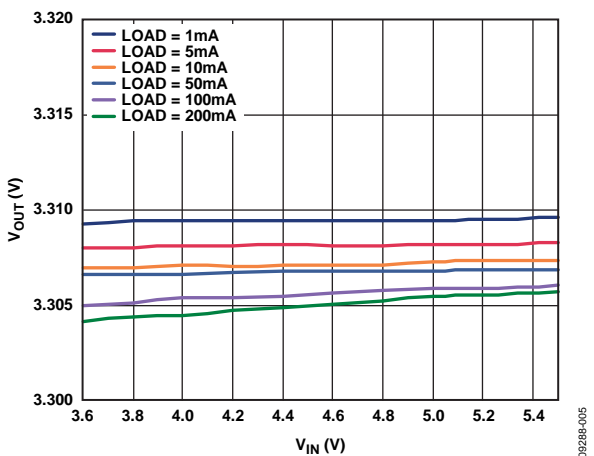

Figure 7. Output Voltage vs. Input Voltage

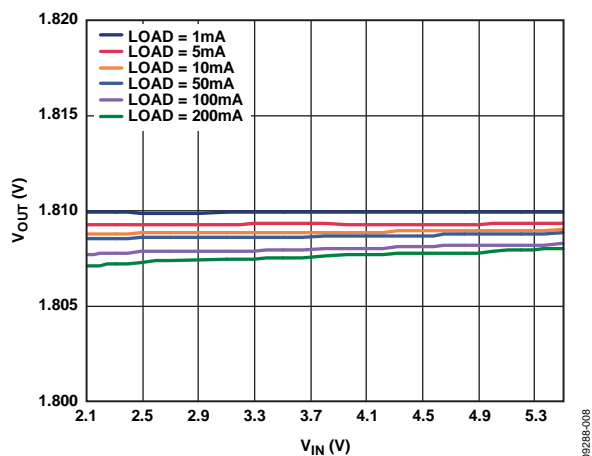

Figure 10. Output Voltage vs. Input Voltage



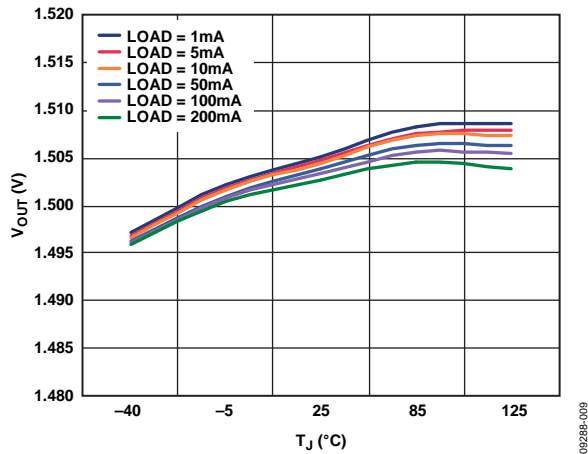

Figure 11. Output Voltage vs. Junction Temperature

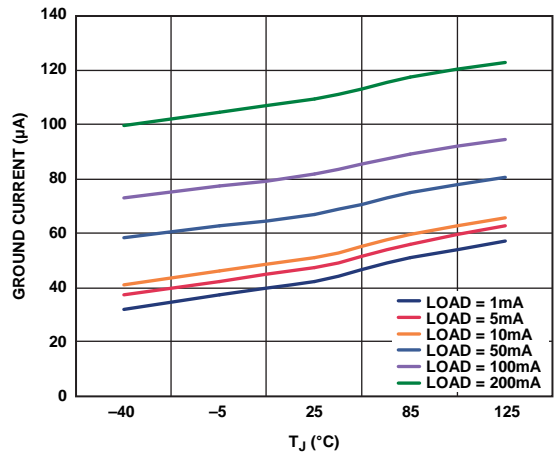

Figure 14. Ground Current vs. Junction Temperature, Single Output Loaded

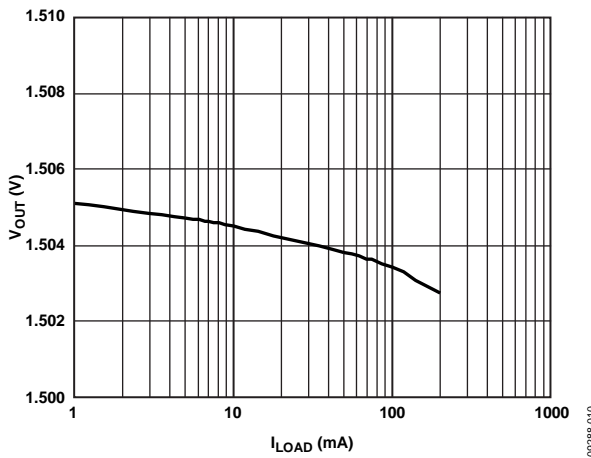

Figure 12. Output Voltage vs. Load Current

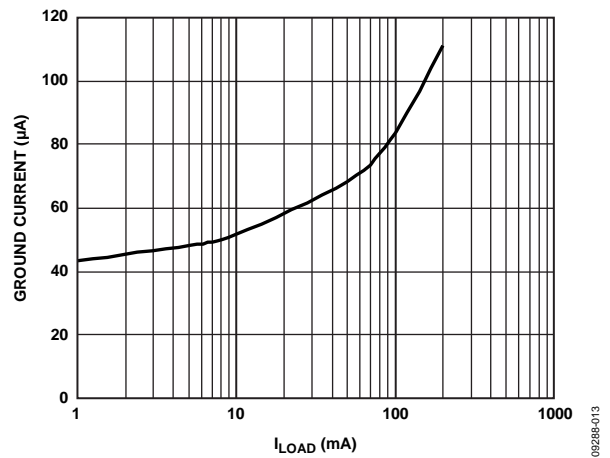

Figure 15. Ground Current vs. Load Current, Single Output Loaded

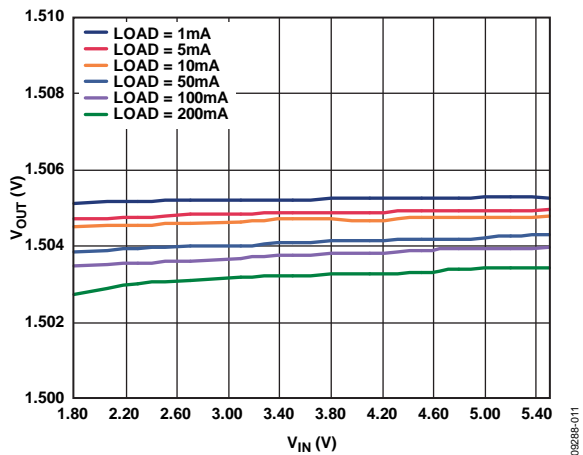

Figure 13. Output Voltage vs. Input Voltage

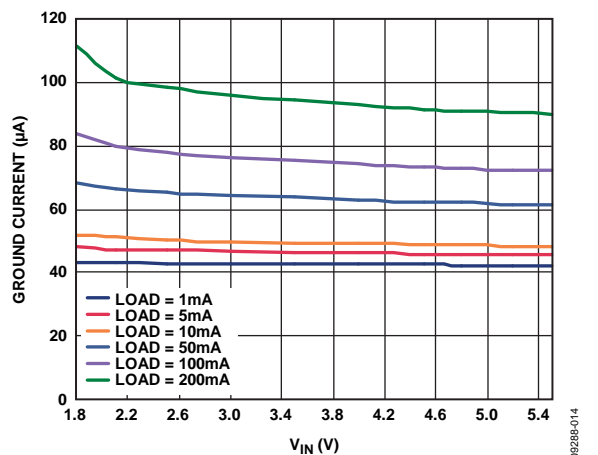

Figure 16. Ground Current vs. Input Voltage, Single Output Loaded

# ADP322/ADP323

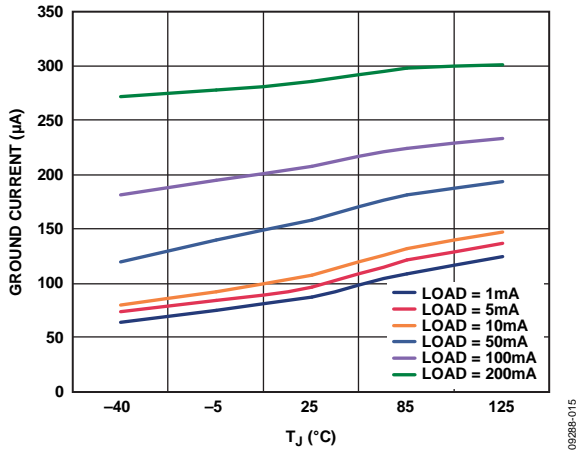

Figure 17. Ground Current vs. Junction Temperature, All Outputs Loaded Equally

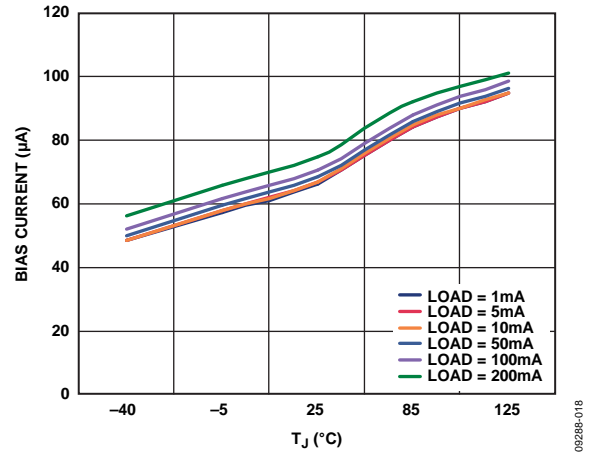

Figure 20. Bias Current vs. Junction Temperature, Single Output Loaded

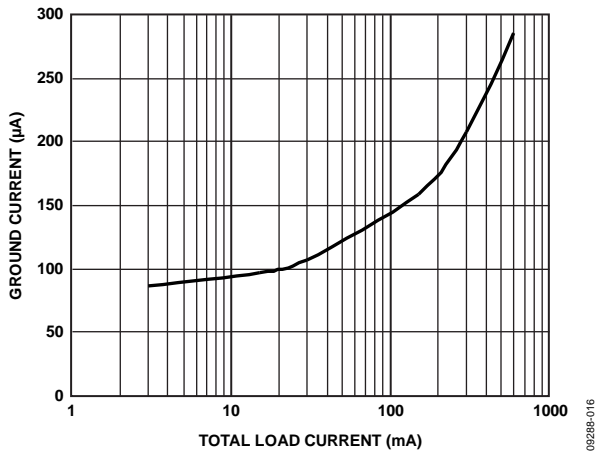

Figure 18. Ground Current vs. Load Current, All Outputs Loaded Equally

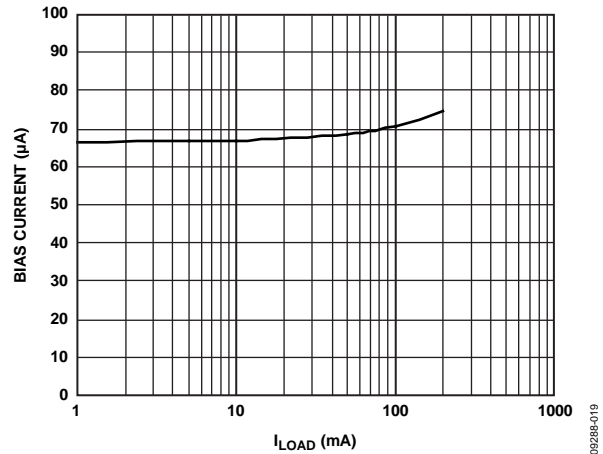

Figure 21. Bias Current vs. Load Current, Single Output Loaded

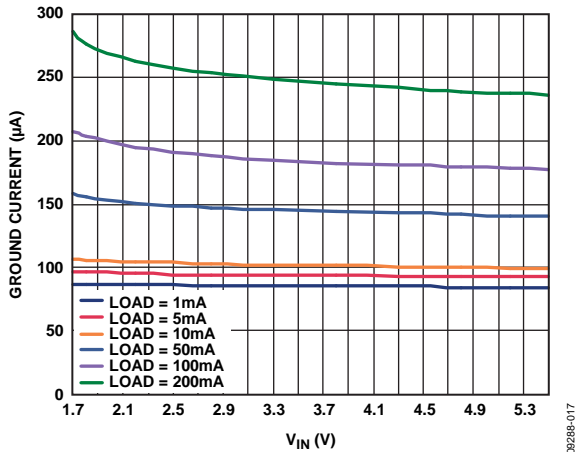

Figure 19. Ground Current vs. Input Voltage, All Outputs Loaded Equally

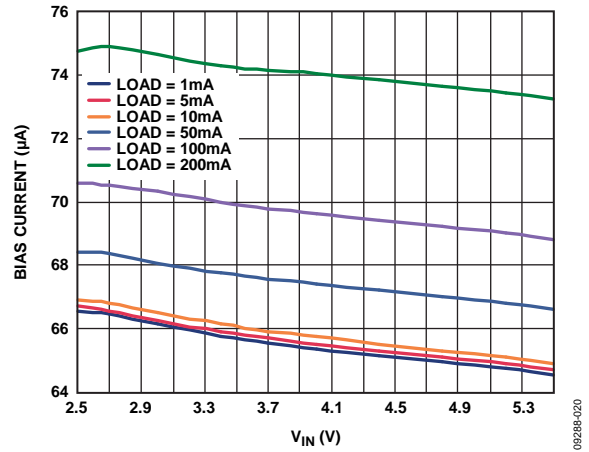

Figure 22. Bias Current vs. Input Voltage, Single Output Loaded

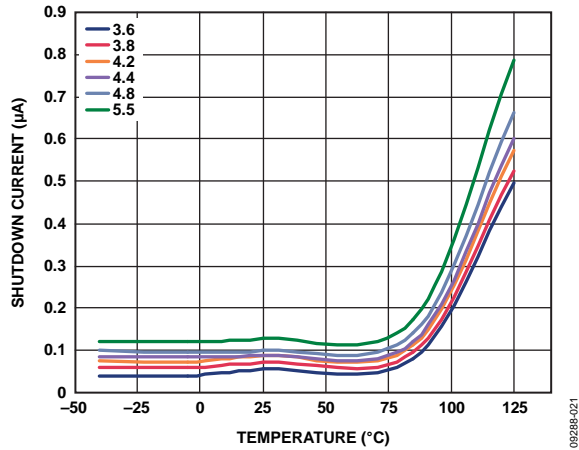

Figure 23. Shutdown Current vs. Temperature at Various Input Voltages

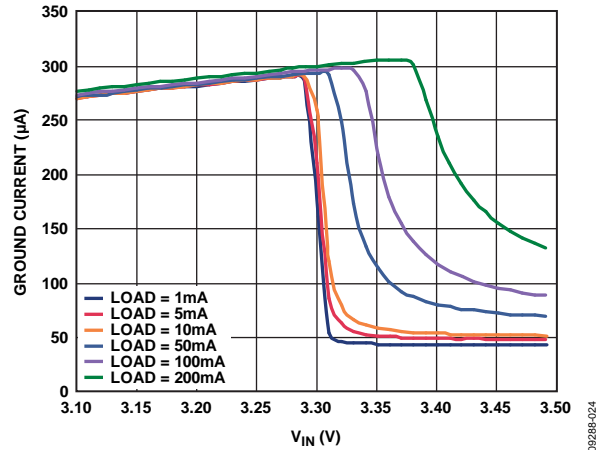

Figure 26. Ground Current vs. Input Voltage (in Dropout),  $V_{OUT1} = 3.3\text{ V}$

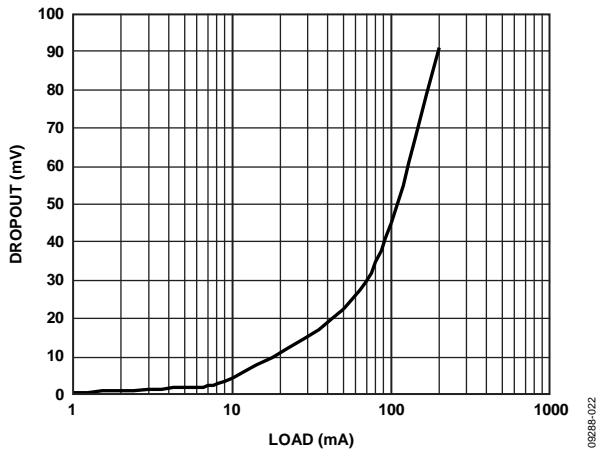

Figure 24. Dropout Voltage vs. Load Current and Output Voltage,  $V_{OUT1} = 3.3\text{ V}$

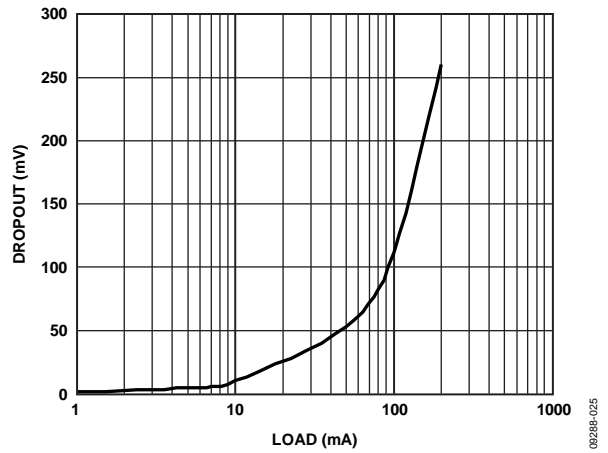

Figure 27. Dropout Voltage vs. Load Current and Output Voltage,  $V_{OUT2} = 1.8\text{ V}$

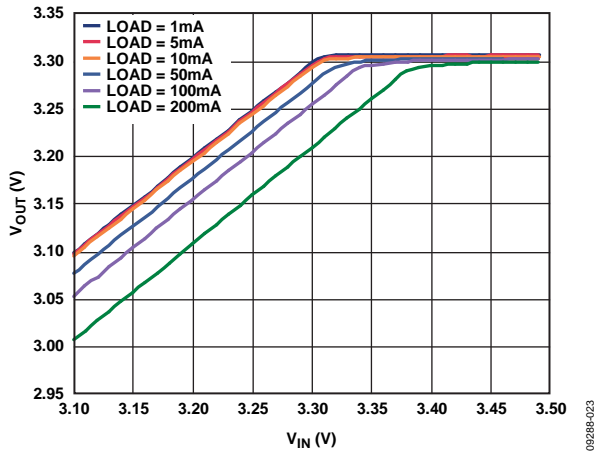

Figure 25. Output Voltage vs. Input Voltage (in Dropout),  $V_{OUT1} = 3.3\text{ V}$

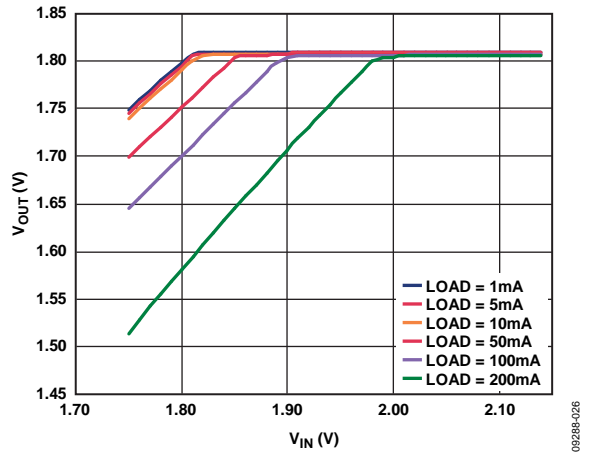

Figure 28. Output Voltage vs. Input Voltage (in Dropout),  $V_{OUT2} = 1.8\text{ V}$

# ADP322/ADP323

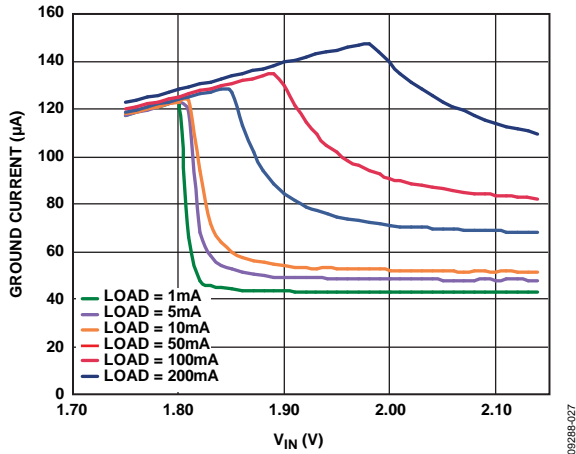

Figure 29. Ground Current vs. Input Voltage (in Dropout),  $V_{OUT2} = 1.8\text{ V}$

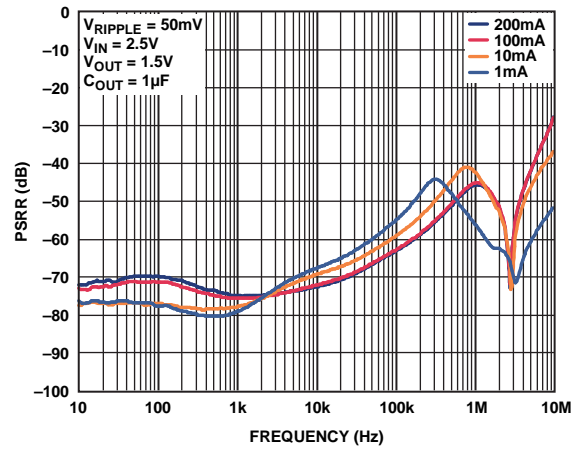

Figure 32. Power Supply Rejection Ratio vs. Frequency, 1.5 V

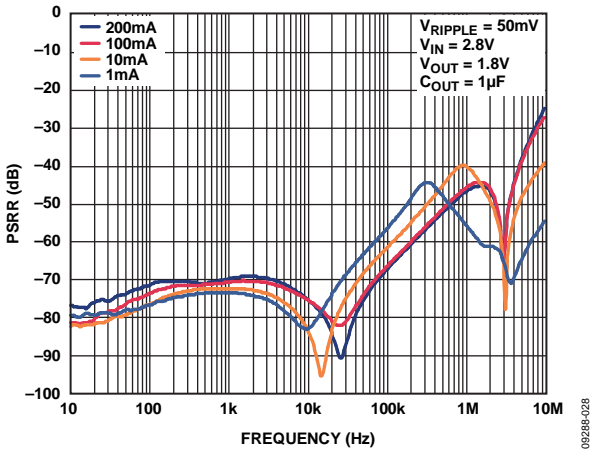

Figure 30. Power Supply Rejection Ratio vs. Frequency, 1.8 V

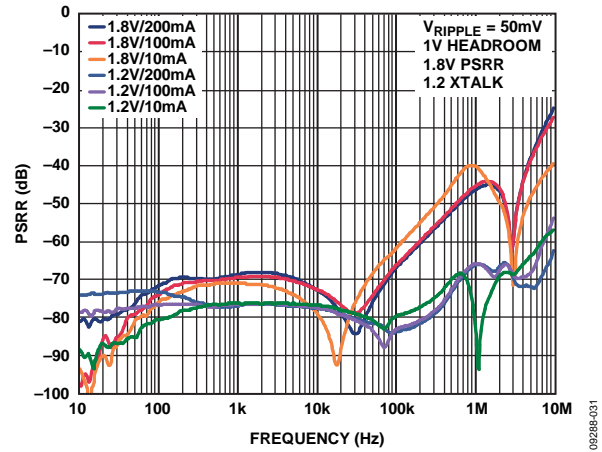

Figure 33. Power Supply Rejection Ratio vs. Frequency, Channel-to-Channel Crosstalk

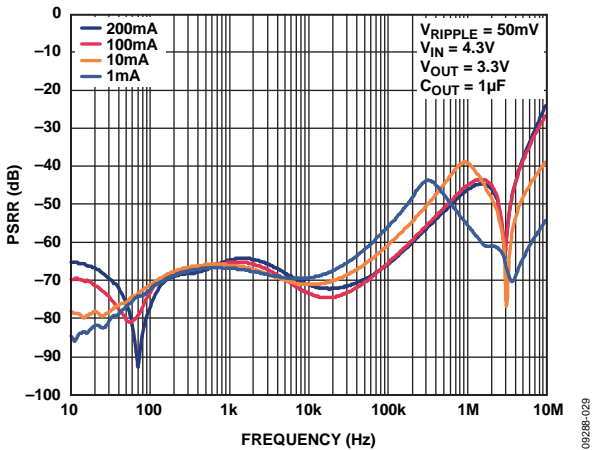

Figure 31. Power Supply Rejection Ratio vs. Frequency, 3.3 V

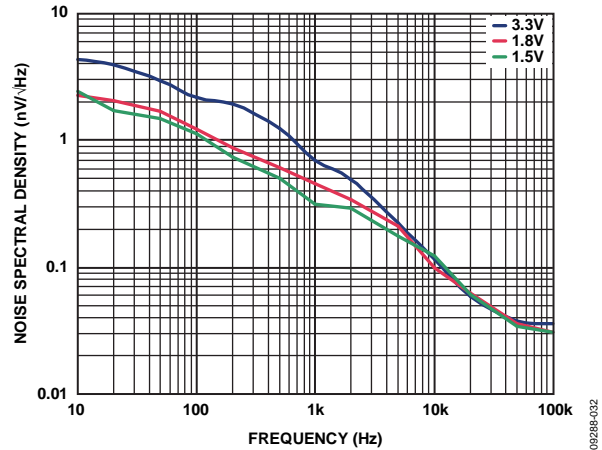

Figure 34. Output Noise Spectral Density vs. Frequency,  $V_{IN} = 5\text{ V}$ ,  $I_{LOAD} = 10\text{ mA}$

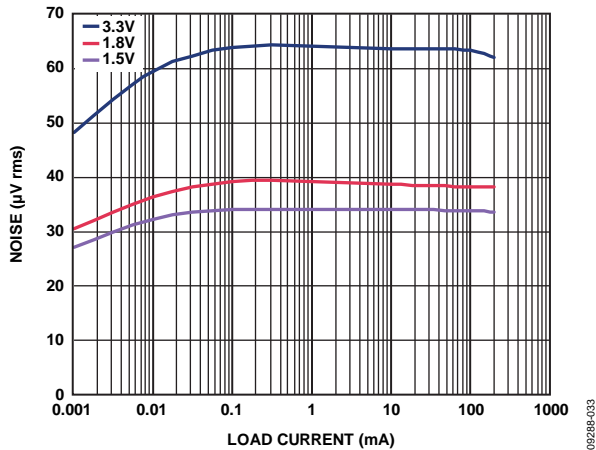

Figure 35. Output Noise vs. Load Current and Output Voltage,  $V_{IN} = 5V$

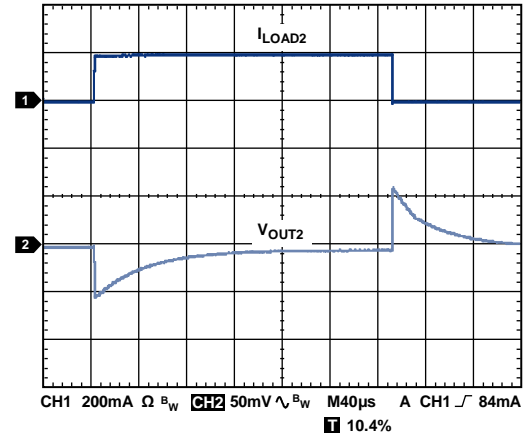

Figure 38. Load Transient Response,  $I_{LOAD2} = 1mA$  to  $200mA$ ,  $C_{OUT2} = 1\mu F$ ,  $CH1 = I_{LOAD2}$ ,  $CH2 = V_{OUT2}$

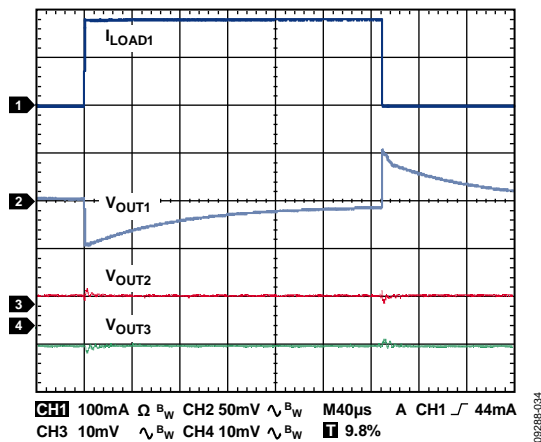

Figure 36. Load Transient Response,  $I_{LOAD1} = 1mA$  to  $200mA$ ,  $I_{LOAD2} = I_{LOAD3} = 1mA$ ,  $CH1 = I_{LOAD1}$ ,  $CH2 = V_{OUT1}$ ,  $CH3 = V_{OUT2}$ ,  $CH4 = V_{OUT3}$

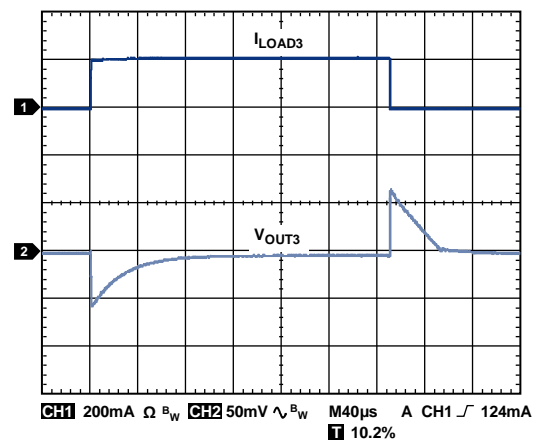

Figure 39. Load Transient Response,  $I_{LOAD3} = 1mA$  to  $200mA$ ,  $C_{OUT3} = 1\mu F$ ,  $CH1 = I_{LOAD3}$ ,  $CH2 = V_{OUT3}$

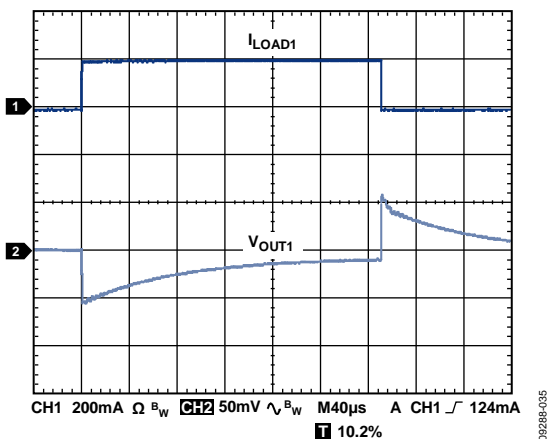

Figure 37. Load Transient Response,  $I_{LOAD1} = 1mA$  to  $200mA$ ,  $C_{OUT1} = 1\mu F$ ,  $CH1 = I_{LOAD1}$ ,  $CH2 = V_{OUT1}$

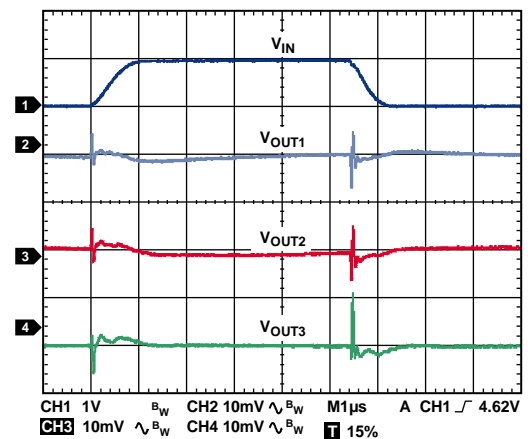

Figure 40. Line Transient Response,  $V_{IN} = 4V$  to  $5V$ ,  $I_{LOAD1} = I_{LOAD2} = I_{LOAD3} = 100mA$ ,  $CH1 = V_{IN}$ ,  $CH2 = V_{OUT1}$ ,  $CH3 = V_{OUT2}$ ,  $CH4 = V_{OUT3}$

# ADP322/ADP323

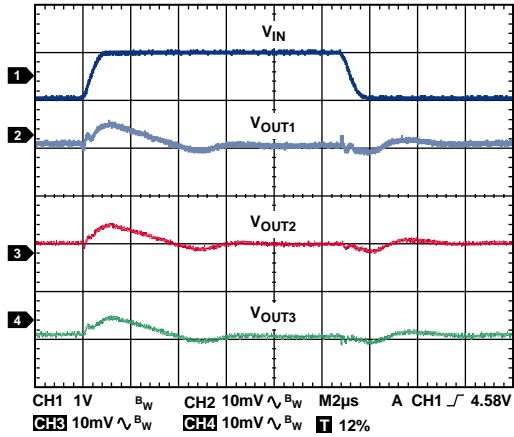

Figure 41. Line Transient Response,  
 $V_{IN} = 4\text{ V to }5\text{ V}$ ,  $I_{LOAD1} = I_{LOAD2} = I_{LOAD3} = 1\text{ mA}$ ,  
 $CH1 = V_{IN}$ ,  $CH2 = V_{OUT1}$ ,  $CH3 = V_{OUT2}$ ,  $CH4 = V_{OUT3}$

06286-039

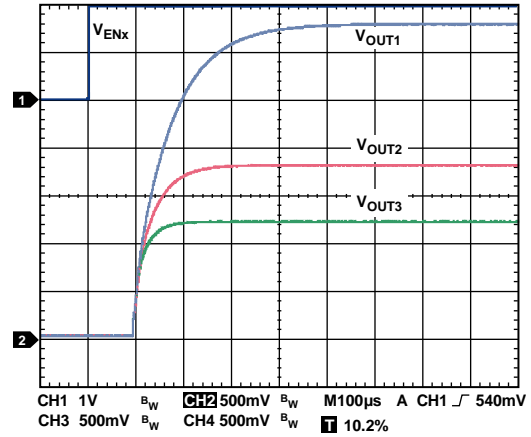

Figure 42. Turn-On Response,  $I_{LOAD1} = I_{LOAD2} = I_{LOAD3} = 100\text{ mA}$ ,  
 $CH1 = V_{ENx}$  (the Enable Voltage),  $CH2 = V_{OUT1}$ ,  $CH3 = V_{OUT2}$ ,  
 $CH4 = V_{OUT3}$

06286-040

## THEORY OF OPERATION

The ADP322/ADP323 triple LDO are low quiescent current, low dropout linear regulators that operate from 1.8 V to 5.5 V on VIN1/VIN2 and VIN3 and provide up to 200 mA of current from each output. Drawing a low 250 µA quiescent current (typical) at full load makes the ADP322/ADP323 ideal for battery-operated portable equipment. Shutdown current consumption is typically 100 nA. Optimized for use with small 1 µF ceramic capacitors, the ADP322/ADP323 provide excellent transient performance.

Internally, the ADP322 consists of a reference, three error amplifiers, three feedback voltage dividers, and three PMOS pass transistors. Output current is delivered via the PMOS pass device, which is controlled by the error amplifier. The error amplifier compares the reference voltage with the feedback voltage from the output and amplifies the difference. If the feedback voltage is lower than the reference voltage, the gate of the PMOS device is pulled lower, allowing more current to flow and increasing the output voltage. If the feedback voltage is higher than the reference voltage, the gate of the PMOS device is pulled higher, allowing less current to flow and decreasing the output voltage.

The ADP323 is exactly the same as the ADP322 except that the output voltage dividers are internally disconnected and the feedback input of the error amplifiers is brought out for each output. The output voltage can be set using the following formula:

$$V_{OUT} = 0.5 V(1 + R1/R2) + (FB_{IN})(R1)$$

The value of R1 should be less than 200 kΩ to minimize errors in the output voltage caused by the FBx pin input current. For example, when R1 and R2 each equal 200 kΩ, the output voltage is 1.0 V. The output voltage error introduced by the FBx pin input current is 2 mV or 0.20%, assuming a typical FBx pin input current of 10 nA at 25°C.

The ADP322 is available in multiple output voltage options ranging from 0.8 V to 3.3 V.

The ADP322/ADP323 use the EN1/EN2 and EN3 pins to enable and disable the VOUT1/VOUT2/VOUT3 pins under normal operating conditions. When the EN1/EN2 and EN3 pins are high, VOUT1/VOUT2/VOUT3 turn on; when the EN1/EN2 and EN3 pins are low, VOUT1/VOUT2/VOUT3 turn off. For automatic startup, the EN1/EN2 and EN3 pins can be tied to VBIAS.

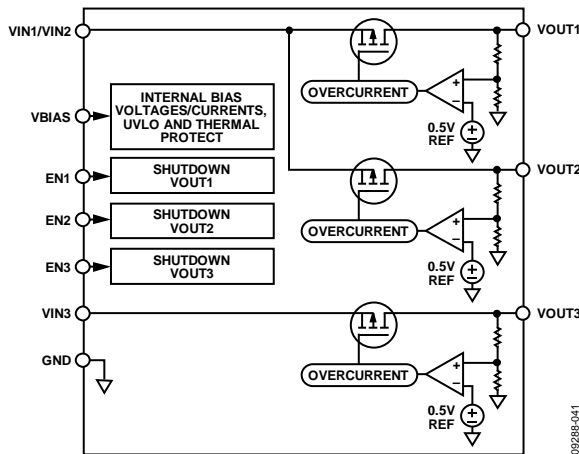

Figure 43. ADP322 Internal Block Diagram

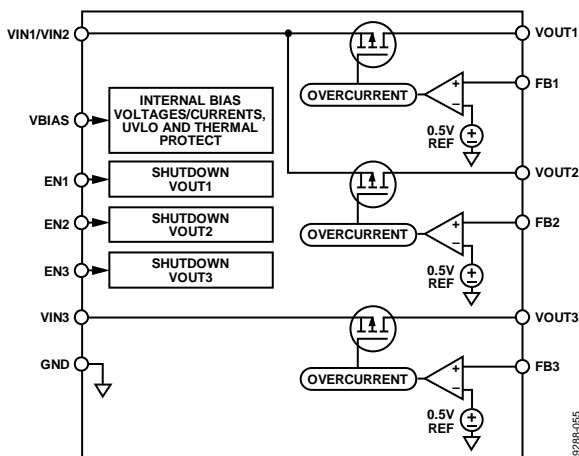

Figure 44. ADP323 Internal Block Diagram

## APPLICATIONS INFORMATION

### CAPACITOR SELECTION

#### Output Capacitor

The ADP322/ADP323 are designed for operation with small, space-saving ceramic capacitors, but the parts function with most commonly used capacitors as long as care is taken with the effective series resistance (ESR) value. The ESR of the output capacitor affects the stability of the LDO control loop. A minimum of 0.70  $\mu\text{F}$  capacitance with an ESR of 1  $\Omega$  or less is recommended to ensure the stability of the ADP322/ADP323.

Transient response to changes in load current is also affected by output capacitance. Using a larger value of output capacitance improves the transient response of the ADP322/ADP323 to large changes in the load current. Figure 45 shows the transient response for an output capacitance value of 1  $\mu\text{F}$ .

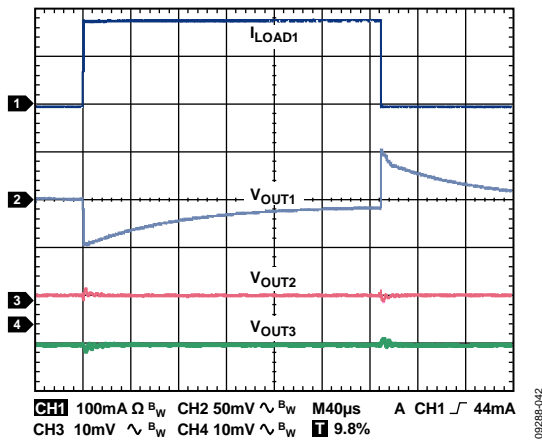

Figure 45. Output Transient Response,  
 $I_{LOAD1} = 1 \text{ mA}$  to  $200 \text{ mA}$ ,  $I_{LOAD2} = 1 \text{ mA}$ ,  $I_{LOAD3} = 1 \text{ mA}$ ,  
 $CH1 = I_{LOAD1}$ ,  $CH2 = V_{OUT1}$ ,  $CH3 = V_{OUT2}$ ,  $CH4 = V_{OUT3}$

#### Input Bypass Capacitor

Connecting a 1  $\mu\text{F}$  capacitor from VIN1/VIN2, VIN3, and VBIAS to GND reduces the circuit sensitivity to the PCB layout, especially when long input traces or high source impedance is encountered. If an output capacitance greater than 1  $\mu\text{F}$  is required, the input capacitor should be increased to match it.

#### Input and Output Capacitor Properties

Any good quality ceramic capacitor can be used with the ADP322/ADP323, as long as the capacitor meets the minimum capacitance and maximum ESR requirements. Ceramic capacitors are manufactured with a variety of dielectrics, each with a different behavior over temperature and applied voltage. Capacitors must have an adequate dielectric to ensure the minimum capacitance over the necessary temperature range and dc bias conditions. X5R or X7R dielectrics with a voltage rating of 6.3 V or 10 V are recommended. Y5V and Z5U dielectrics are not recommended due to their poor temperature and dc bias characteristics.

Figure 46 depicts the capacitance vs. voltage bias characteristic of a 0402 1  $\mu\text{F}$ , 10 V, X5R capacitor. The voltage stability of a capacitor is strongly influenced by the capacitor size and voltage rating. In general, a capacitor in a larger package or with a higher voltage rating exhibits better stability. The temperature variation of the X5R dielectric is about  $\pm 15\%$  over the  $-40^\circ\text{C}$  to  $+85^\circ\text{C}$  temperature range and is not a function of the package or voltage rating.

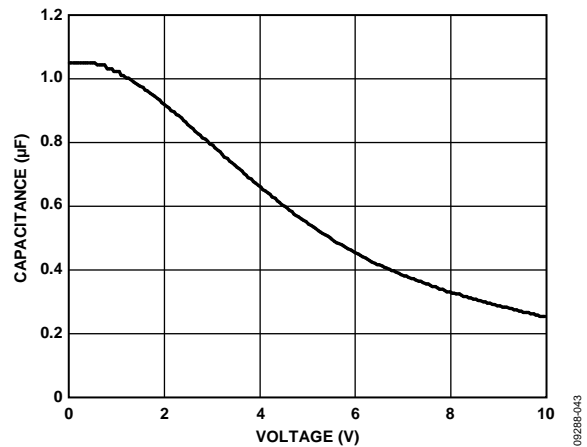

Figure 46. Capacitance vs. Voltage Bias Characteristic



Use Equation 1 to determine the worst-case capacitance, accounting for capacitor variation over temperature, component tolerance, and voltage.

$$C_{EFF} = C_{BIAS} \times (1 - TEMPCO) \times (1 - TOL) \quad (1)$$

where:

$C_{BIAS}$  is the effective capacitance at the operating voltage.  
 $TEMPCO$  is the worst-case capacitor temperature coefficient.  
 $TOL$  is the worst-case component tolerance.

In this example,  $TEMPCO$  over  $-40^{\circ}\text{C}$  to  $+85^{\circ}\text{C}$  is assumed to be 15% for an X5R dielectric.  $TOL$  is assumed to be 10%, and  $C_{BIAS}$  is  $0.94 \mu\text{F}$  at 1.8 V (from the graph in Figure 46).

Substituting these values into Equation 1 yields

$$C_{EFF} = 0.94 \mu\text{F} \times (1 - 0.15) \times (1 - 0.1) = 0.719 \mu\text{F}$$

Therefore, the capacitor chosen in this example meets the minimum capacitance requirement of the LDO over temperature and tolerance at the chosen output voltage.

To guarantee the performance of the ADP322/ADP323 triple LDO, it is imperative that the effects of dc bias, temperature, and tolerances on the behavior of the capacitors be evaluated for each application.

## UNDERVOLTAGE LOCKOUT

The ADP322/ADP323 have an internal undervoltage lockout circuit that disables all inputs and the output when the input voltage bias,  $V_{BIAS}$ , is less than approximately 2.2 V. This ensures that the inputs of the ADP322/ADP323 and the output behave in a predictable manner during power-up.

## ENABLE FEATURE

The ADP322/ADP323 use the  $ENx$  pins to enable and disable the  $V_{OUTx}$  pins under normal operating conditions. Figure 47 shows that, when a rising voltage on  $ENx$  crosses the active threshold,  $V_{OUTx}$  turns on. When a falling voltage on  $ENx$  crosses the inactive threshold,  $V_{OUTx}$  turns off.

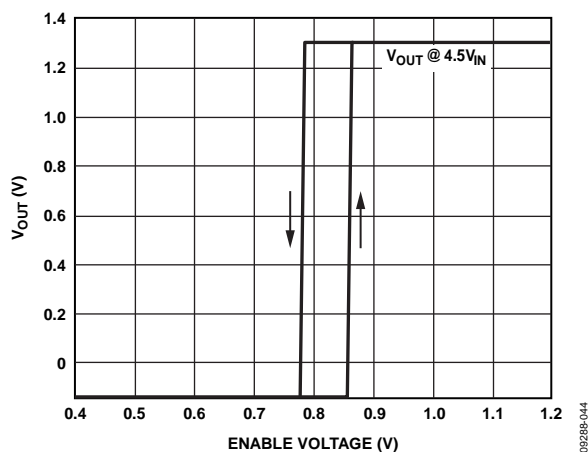

Figure 47. Typical ENx Pin Operation

As shown in Figure 47, the  $ENx$  pin has built-in hysteresis. This prevents on/off oscillations that can occur due to noise on the  $ENx$  pin as it passes through the threshold points.

The active/inactive thresholds of the  $ENx$  pin are derived from the  $V_{BIAS}$  voltage. Therefore, these thresholds vary with changing input voltage. Figure 48 shows typical  $ENx$  active/inactive thresholds when the input voltage varies from 2.5 V to 5.5 V (note that  $V_{ENx}$  is the enable voltage).

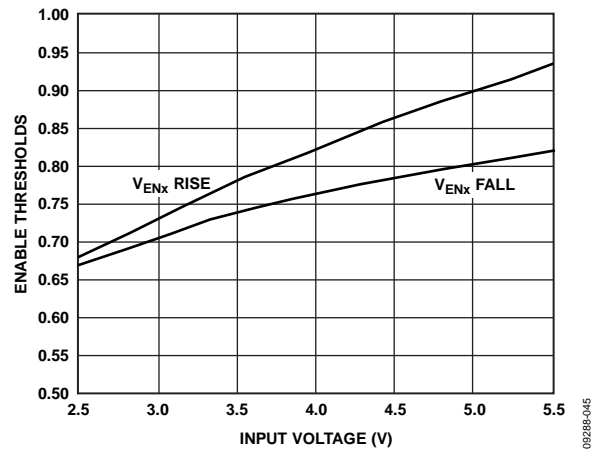

Figure 48. Typical ENx Pins Thresholds vs. Input Voltage

The ADP322/ADP323 use an internal soft start to limit the inrush current when the output is enabled. The start-up time for the 2.8 V option is approximately 220  $\mu\text{s}$  from the time the  $ENx$  active threshold is crossed to when the output reaches 90% of its final value. The start-up time is somewhat dependent on the output voltage setting and increases slightly as the output voltage increases.

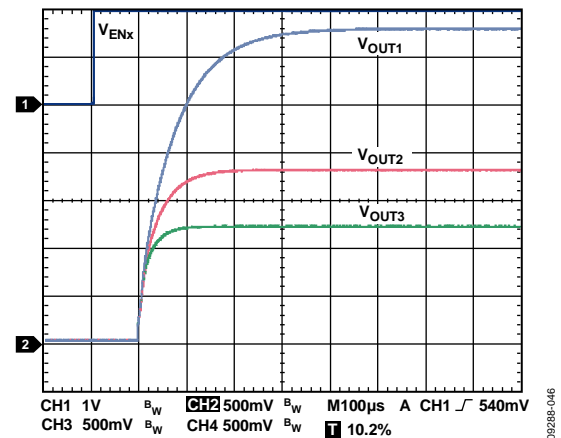

Figure 49. Typical Start-Up Time,  $I_{LOAD1} = I_{LOAD2} = I_{LOAD3} = 100 \text{ mA}$ ,  $CH1 = V_{ENx}$  (the Enable Voltage),  $CH2 = V_{OUT1}$ ,  $CH3 = V_{OUT2}$ ,  $CH4 = V_{OUT3}$

## CURRENT-LIMIT AND THERMAL OVERLOAD PROTECTION

The ADP322/ADP323 are protected against damage due to excessive power dissipation by current and thermal overload protection circuits. The ADP322/ADP323 are designed to current limit when the output load reaches 300 mA (typical). When the output load exceeds 300 mA, the output voltage is reduced to maintain a constant current limit.

Thermal overload protection is built in, which limits the junction temperature to a maximum of 155°C (typical). Under extreme conditions (that is, high ambient temperature and power dissipation) when the junction temperature starts to rise above 155°C, the output is turned off, reducing the output current to zero. When the junction temperature drops below 140°C, the output is turned on again and the output current is restored to its nominal value.

Consider the case where a hard short from VOUTx to GND occurs. At first, the ADP322/ADP323 limits current so that only 300 mA is conducted into the short. If self-heating of the junction is great enough to cause its temperature to rise above 155°C, thermal shutdown activates, turning off the output and reducing the output current to zero. As the junction temperature cools and drops below 140°C, the output turns on and conducts 300 mA into the short, again causing the junction temperature to rise above 155°C. This thermal oscillation between 140°C and 155°C causes a current oscillation between 0 mA and 300 mA that continues as long as the short remains at the output.

Current and thermal limit protections are intended to protect the device against accidental overload conditions. For reliable operation, device power dissipation must be externally limited so that junction temperatures do not exceed 125°C.

## THERMAL CONSIDERATIONS

In most applications, the ADP322/ADP323 do not dissipate a lot of heat due to high efficiency. However, in applications with a high ambient temperature and high supply voltage to output voltage differential, the heat dissipated in the package is large enough that it can cause the junction temperature of the die to exceed the maximum junction temperature of 125°C.

When the junction temperature exceeds 155°C, the converter enters thermal shutdown. It recovers only after the junction temperature decreases below 140°C to prevent any permanent damage. Therefore, thermal analysis for the chosen application is very important to guarantee reliable performance over all conditions. The junction temperature of the die is the sum of the ambient temperature of the environment and the temperature rise of the package due to the power dissipation, as shown in Equation 2.

To guarantee reliable operation, the junction temperature of the ADP322/ADP323 must not exceed 125°C. To ensure that the junction temperature stays below this maximum value, the user must be aware of the parameters that contribute to junction temperature changes. These parameters include ambient temperature, power dissipation in the power device, and thermal resistances between the junction and ambient air ( $\theta_A$ ). The  $\theta_A$  number is dependent on the package assembly compounds used and the amount of copper to which the GND pins of the package are soldered on the PCB. Table 7 shows typical  $\theta_A$  values for the ADP322/ADP323 for various PCB copper sizes.

**Table 7. Typical  $\theta_A$  Values**

Copper Size (mm <sup>2</sup> )	ADP322/ADP323 Triple LDO (°C/W)
JEDEC <sup>1</sup>	49.5
100	83.7
500	68.5
1000	64.7

<sup>1</sup> Device soldered to JEDEC standard board.

The junction temperature of the ADP322/ADP323 can be calculated from the following equation:

$$T_J = T_A + (P_D \times \theta_{JA}) \quad (2)$$

where:

$T_A$  is the ambient temperature.

$P_D$  is the power dissipation in the die, given by

$$P_D = \Sigma[(V_{IN} - V_{OUT}) \times I_{LOAD}] + \Sigma(V_{IN} \times I_{GND}) \quad (3)$$

where:

$I_{LOAD}$  is the load current.

$I_{GND}$  is the ground current.

$V_{IN}$  and  $V_{OUT}$  are input and output voltages, respectively.

Power dissipation due to ground current is quite small and can be ignored. Therefore, the junction temperature equation simplifies to

$$T_J = T_A + \{\Sigma[(V_{IN} - V_{OUT}) \times I_{LOAD}] \times \theta_{JA}\} \quad (4)$$

As shown in Equation 4, for a given ambient temperature, input-to-output voltage differential, and continuous load current, there exists a minimum copper size requirement for the PCB to ensure that the junction temperature does not rise above 125°C. Figure 50 to Figure 53 show junction temperature calculations for different ambient temperatures, total power dissipation, and areas of PCB copper.

In cases where the board temperature is known, the thermal characterization parameter,  $\Psi_{JB}$ , can be used to estimate the junction temperature rise.  $T_J$  is calculated from  $T_B$  and  $P_D$  using the formula

$$T_J = T_B + (P_D \times \Psi_{JB}) \quad (5)$$

The typical  $\Psi_{JB}$  value for the 16-lead, 3 mm × 3 mm LFCSP is 25.2°C/W.

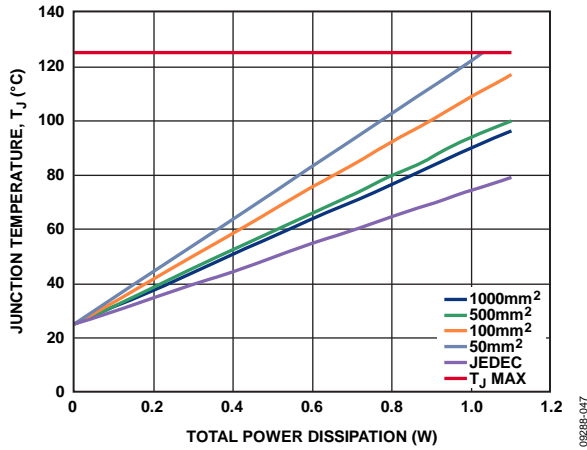

Figure 50. Junction Temperature vs. Total Power Dissipation,  $T_A = 25^\circ\text{C}$

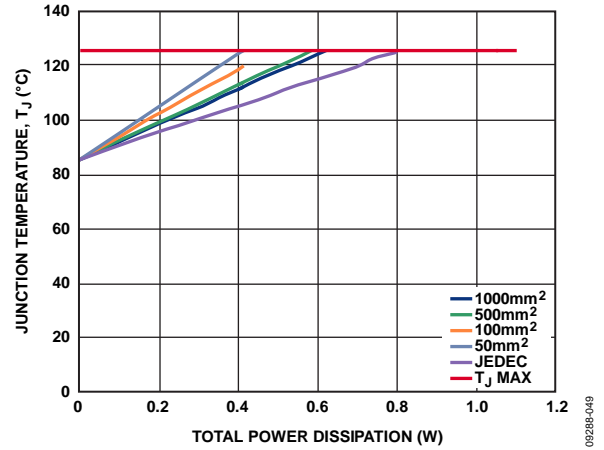

Figure 52. Junction Temperature vs. Total Power Dissipation,  $T_A = 85^\circ\text{C}$

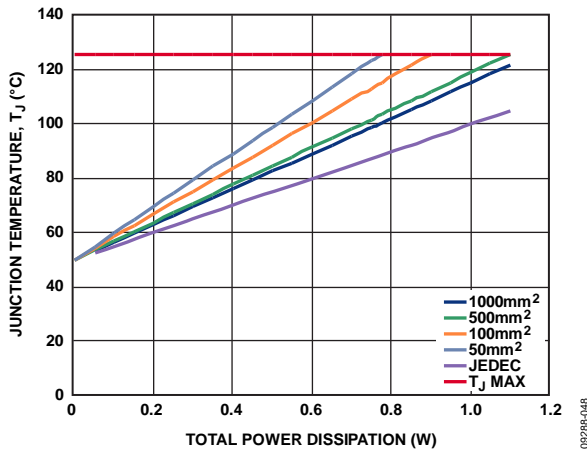

Figure 51. Junction Temperature vs. Total Power Dissipation,  $T_A = 50^\circ\text{C}$

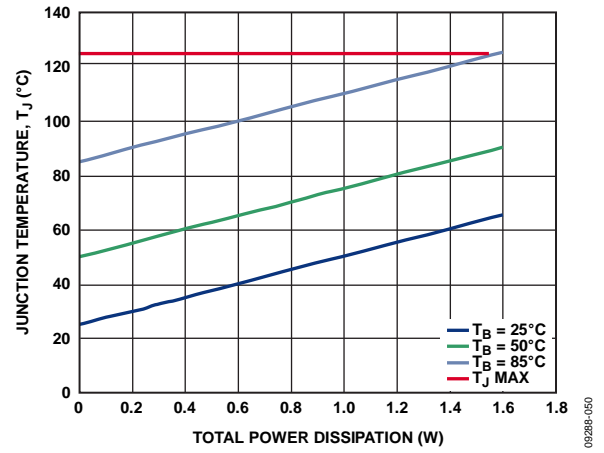

Figure 53. Junction Temperature vs. Total Power Dissipation and Board Temperature

# ADP322/ADP323

## PRINTED CIRCUIT BOARD LAYOUT CONSIDERATIONS

Heat dissipation from the package can be improved by increasing the amount of copper attached to the pins of the ADP322/ADP323. However, as can be seen from Table 7, a point of diminishing returns is eventually reached, beyond which an increase in the copper size does not yield significant heat dissipation benefits.

Place the input capacitor as close as possible to the VINx and GND pins. Place the output capacitors as close as possible to the VOUTx and GND pins. Use 0402 or 0603 size capacitors and resistors to achieve the smallest possible footprint solution on boards where area is limited.

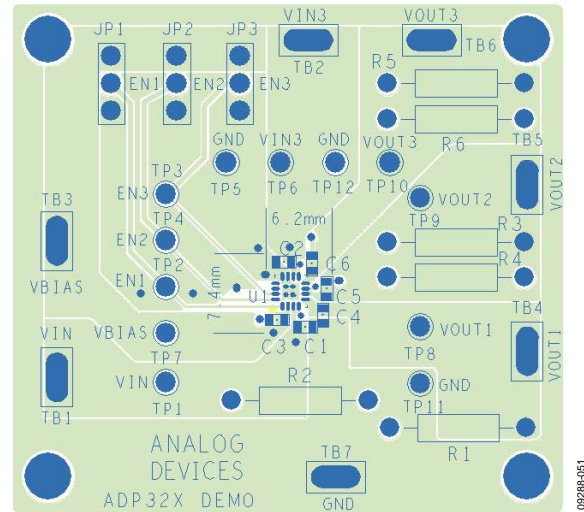

Figure 54. Example of PCB Layout, Top Side

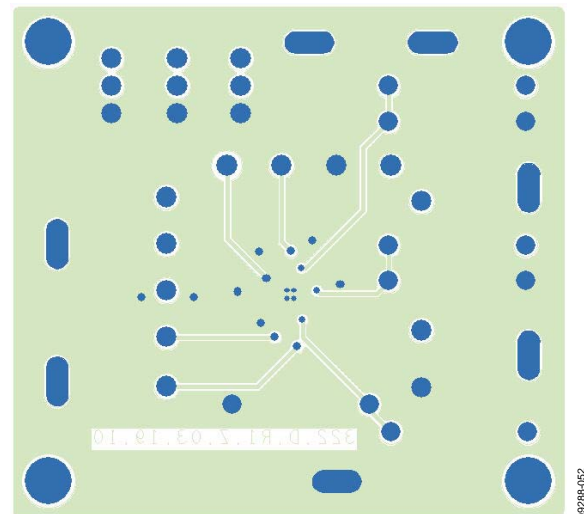
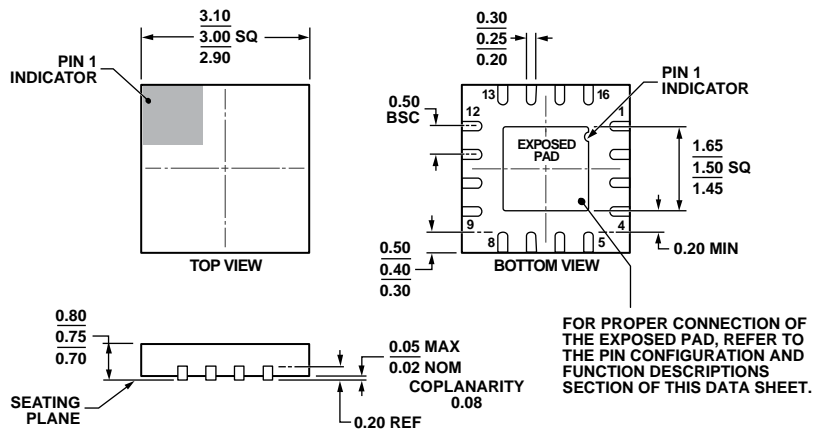

Figure 55. Example of PCB Layout, Bottom Side

# OUTLINE DIMENSIONS



COMPLIANT TO JEDEC STANDARDS MO-229.

Figure 56. 16-Lead Lead Frame Chip Scale Package [LFCSWQ]  
 3 mm × 3 mm Body, Very, Very Thin Quad  
 (CP-16-27)  
 Dimensions shown in millimeters

091609-A

## ORDERING GUIDE

Model <sup>1</sup>	Temperature Range	Output Voltage (V) <sup>2</sup>			Package Description	Package Option	Branding
		VOUT1	VOUT2	VOUT3			
ADP322ACPZ-115-R7	-40°C to +125°C	3.3 V	2.8 V	1.8 V	16-Lead LFCSWQ	CP-16-27	LGU
ADP322ACPZ-135-R7	-40°C to +125°C	3.3 V	2.5 V	1.8 V	16-Lead LFCSWQ	CP-16-27	LGT
ADP322ACPZ-145-R7	-40°C to +125°C	3.3 V	2.5 V	1.2 V	16-Lead LFCSWQ	CP-16-27	LJC
ADP322ACPZ-155-R7	-40°C to +125°C	3.3 V	1.8 V	1.5 V	16-Lead LFCSWQ	CP-16-27	LGS
ADP322ACPZ-175-R7	-40°C to +125°C	2.8 V	1.8 V	1.2 V	16-Lead LFCSWQ	CP-16-27	LGR
ADP322ACPZ-189-R7	-40°C to +125°C	2.5 V	1.8 V	1.2 V	16-Lead LFCSWQ	CP-16-27	LJD
ADP323ACPZ-R7	-40°C to +125°C	Adjustable	Adjustable	Adjustable	16-Lead LFCSWQ	CP-16-27	LGQ

<sup>1</sup> Z = RoHS Compliant Part.

<sup>2</sup> For additional voltage options, contact a [local sales or distribution representative](#).

**NOTES**

**NOTES**

**NOTES**