

HIGH-WITHSTAND VOLTAGE LOW CURRENT CONSUMPTION LOW DROPOUT CMOS VOLTAGE REGULATOR

www.sii-ic.com

© Seiko Instruments Inc., 2009-2010

Rev.2.0_00

The S-1142 Series, developed based on high-withstand voltage CMOS process, is a positive voltage regulator with a high-withstand voltage, low current consumption, and high output voltage accuracy. The S-1142 Series operates at a high maximum operating voltage of 50 V and a low current consumption of 4.0 μ A (typ.). In addition to a built-in low on-resistance transistor which provides a very small dropout voltage and a large output current, this voltage regulator also has a built-in power-off circuit.

An overcurrent protector prevents the load current from exceeding the capacitance of the output transistor. A built-in thermal shutdown circuit prevents damage caused by heat.

A high heat radiation HSOP-6 package enables high-density mounting.

■ Features

- Output voltage : 2.0 V to 12.0 V, selectable in 0.1 V step
- Low equivalent series resistance capacitor : Ceramic capacitor of 0.1 μ F or more can be used as the I/O capacitor.
- Input voltage : 3.0 V to 50 V
- High-accuracy output voltage : $\pm 1.0\%$ (at $T_j = +25^\circ\text{C}$), $\pm 3.0\%$ ($T_j = -40^\circ\text{C}$ to $+105^\circ\text{C}$)
- Low current consumption : During operation: 4.0 μ A typ., 9.0 μ A max. ($T_j = -40^\circ\text{C}$ to $+105^\circ\text{C}$)
During shutdown: 0.1 μ A typ., 1.0 μ A max. ($T_j = -40^\circ\text{C}$ to $+105^\circ\text{C}$)
- Output current : 200 mA (at $V_{IN} \geq V_{OUT(S)} + 2.0 \text{ V}$)^{*1}
- Built-in overcurrent protector : limits overcurrent of output transistor
- Operation temperature range : -40°C to $+105^\circ\text{C}$ (S-1142xxxH only)
- Built-in thermal shutdown circuit : prevents damage caused by heat
- Built-in power on/off circuit : longer battery life
- Lead-free, Sn 100%, halogen-free^{*2}

*1. Attention should be paid to the power dissipation of the package when the output current is large.

*2. Refer to "■ Product Name Structure" for details.

■ Applications

- Constant-voltage power supply for electrical applications for vehicle interiors (S-1142xxxH only)
- Constant-voltage power supplies for home electric appliances

■ Package

- HSOP-6

Caution Before using this product in medical equipment or automobile equipment including car audio, keyless entry and engine control unit, contact to SII is indispensable.

■ Block Diagram

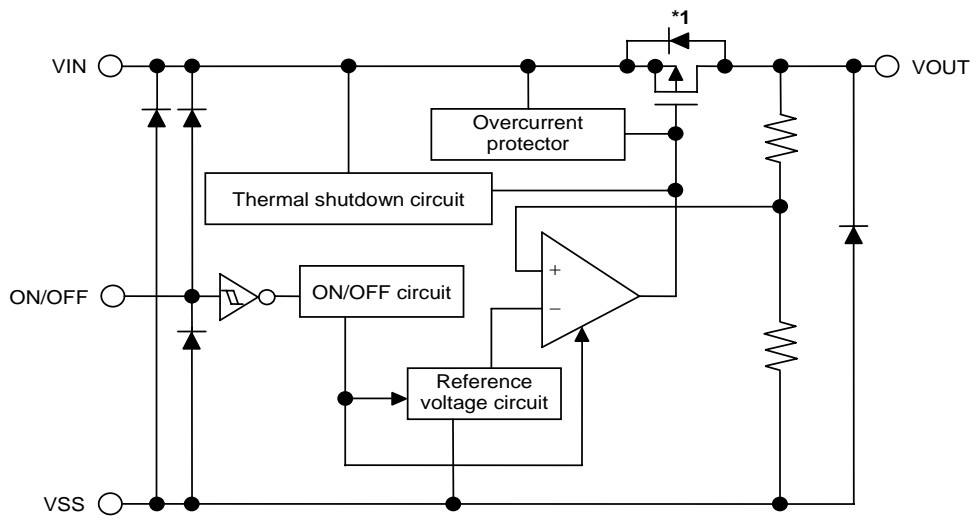

*1. Parasitic diode

Figure 1

■ Product Name Structure

Users can select the product type, output voltage, and package type for the S-1142 Series. For the contents of product name, refer to “**1. Product Name**”, “**2. Package**” regarding the package drawings and “**3. Product Name List**” for details of product names.

1. Product Name

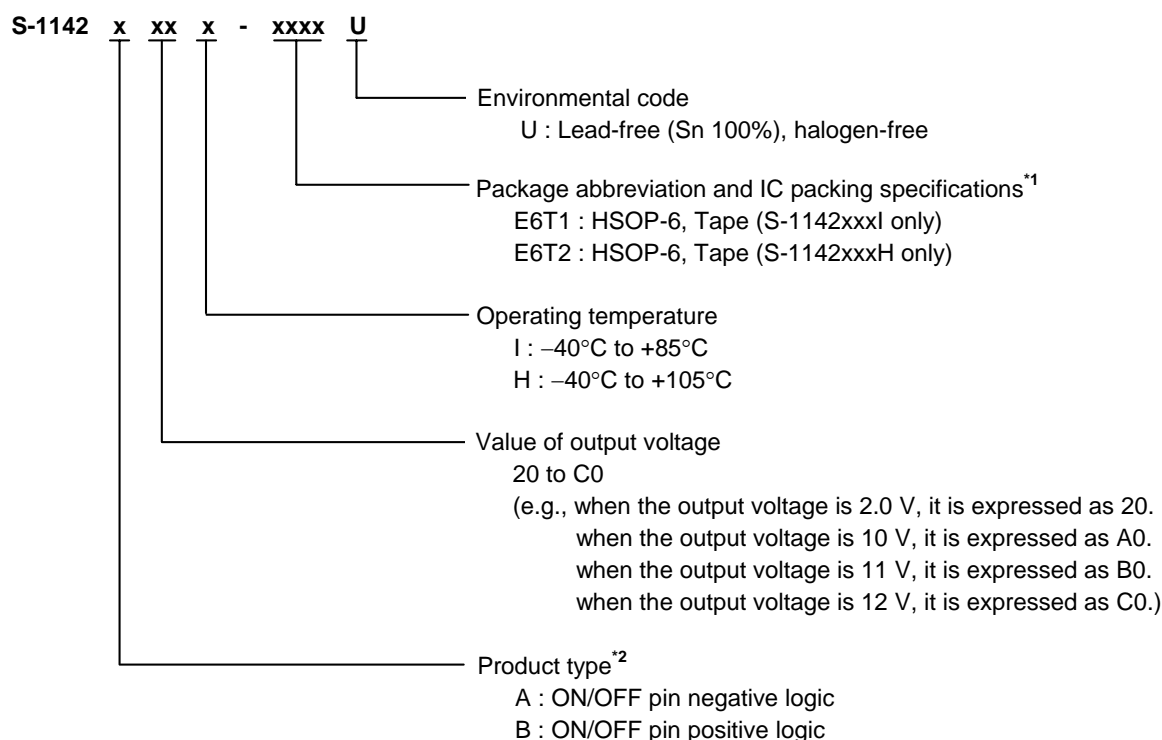

*1. Refer to the tape specifications.

*2. Refer to “**3. Power-off pin (ON/OFF pin)**” in “**■ Operation**”.

2. Package

Package Name	Drawing Code			
	Package	Tape	Reel	Land
HSOP-6	FH006-A-P-SD	FH006-A-C-SD	FH006-A-R-SD	FH006-A-L-SD

3. Product Name List

Table 1

Output Voltage	HSOP-6 (+85°C supported)	HSOP-6 (+105°C supported)
2.0 V \pm 1.0%	S-1142B20I-E6T1U	S-1142B20H-E6T2U
2.5 V \pm 1.0%	S-1142B25I-E6T1U	S-1142B25H-E6T2U
2.7 V \pm 1.0%	S-1142B27I-E6T1U	S-1142B27H-E6T2U
2.8 V \pm 1.0%	S-1142B28I-E6T1U	S-1142B28H-E6T2U
2.85 V \pm 1.0%	S-1142B2JI-E6T1U	S-1142B2JH-E6T2U
3.0 V \pm 1.0%	S-1142B30I-E6T1U	S-1142B30H-E6T2U
3.2 V \pm 1.0%	S-1142B32I-E6T1U	S-1142B32H-E6T2U
3.3 V \pm 1.0%	S-1142B33I-E6T1U	S-1142B33H-E6T2U
3.5 V \pm 1.0%	S-1142B35I-E6T1U	S-1142B35H-E6T2U
3.7 V \pm 1.0%	S-1142B37I-E6T1U	S-1142B37H-E6T2U
4.0 V \pm 1.0%	S-1142B40I-E6T1U	S-1142B40H-E6T2U
5.0 V \pm 1.0%	S-1142B50I-E6T1U	S-1142B50H-E6T2U
8.0 V \pm 1.0%	S-1142B80I-E6T1U	S-1142B80H-E6T2U

- Remark 1.** Please contact our sales office for products with an output voltage other than those listed above or type A products.
- 2.** Please select products of environmental code = U for Sn 100%, halogen-free products.

■ Pin Configuration

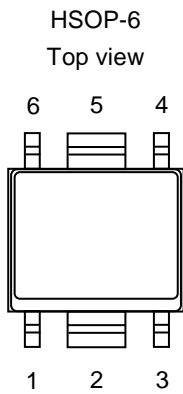

Figure 2

Table 2

Pin No.	Symbol	Description
1	VOUT	Output voltage pin
2	VSS	GND pin
3	ON/OFF	Power-off pin
4	NC ^{*1}	No connection
5	VSS	GND pin
6	VIN	Input voltage pin

*1. The NC pin is electrically open.
The NC pin can be connected to VIN or VSS.

■ **Absolute Maximum Ratings**

Caution The absolute maximum ratings are rated values exceeding which the product could suffer physical damage. These values must therefore not be exceeded under any conditions.

Table 3

(Ta = 25°C unless otherwise specified)

Parameter	Symbol	Absolute Maximum Rating	Unit	
Input voltage	V _{IN}	V _{SS} - 0.3 to V _{SS} + 60	V	
	V _{ON/OFF}	V _{SS} - 0.3 to V _{IN} + 0.3	V	
Output voltage	V _{OUT}	V _{SS} - 0.3 to V _{IN} + 0.3	V	
Power dissipation	P _D	1900 ^{*1}	mW	
Junction temperature	T _j	-40 to +125	°C	
Operating ambient temperature	S-1142xxxL S-1142xxxH	T _{opr}	-40 to +85	°C
			-40 to +105	°C
Storage temperature	T _{stg}	-40 to +125	°C	

*1. When mounted on board

[Mounted board]

- (1) Board size : 50 mm × 50 mm × t1.6 mm
- (2) Board material : Glass epoxy resin (two layers)
- (3) Wiring ratio : 50%
- (4) Test conditions : When mounted on board (wind speed : 0 m/s)
- (5) Land pattern : Refer to the recommended land pattern (drawing code : FH006-A-L-SD)

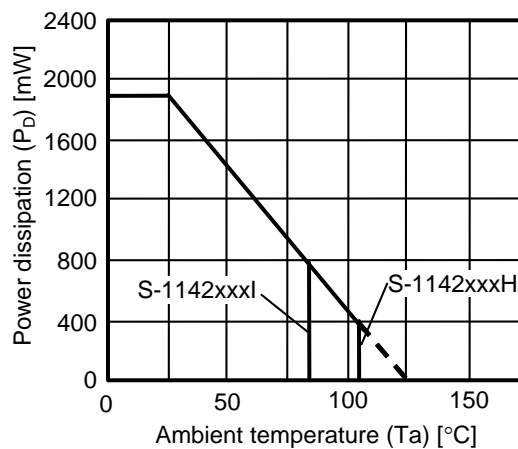

Figure 3 Power Dissipation of Package (When Mounted on Board)

Table 4

Condition	Power Dissipation	Thermal Resistance Value (θj - a)
HSOP-6 (When mounted on board)	1900 mW	53°C/W

Power dissipation of HSOP-6 (reference)

Package power dissipation differs depending on the mounting conditions.

The power dissipation characteristics under the following test conditions should be taken as reference values only.

[Mounted board]

- (1) Board size : 50 mm × 50 mm × t1.6 mm
- (2) Board material : Glass epoxy resin (two layers)
- (3) Wiring ratio : 90%
- (4) Test conditions : When mounted on board (wind speed : 0 m/s)
- (5) Land pattern : Refer to the recommended land pattern (drawing code : FH006-A-L-SD)

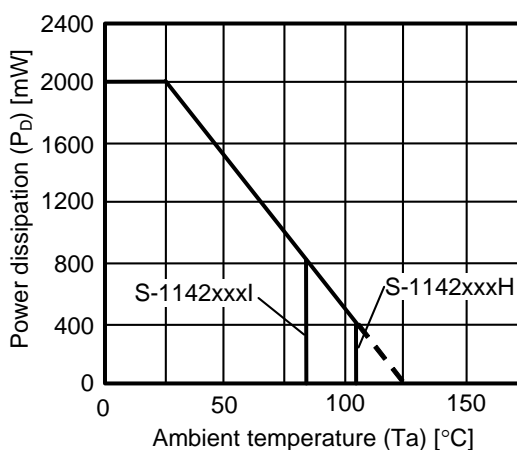

Figure 4 Power Dissipation of Package (When Mounted on Board)

Table 5

Condition	Power Dissipation (Reference)	Thermal Resistance Value ($\theta_j - a$)
HSOP-6 (When mounted on board)	2000 mW	50°C/W

■ Electrical Characteristics

1. S-1142xxxI (+85°C supported)

Table 6

($V_{IN} = V_{OUT(S)} + 1.0 \text{ V}$, $T_j = -40^\circ\text{C}$ to $+125^\circ\text{C}$, $T_a = -40^\circ\text{C}$ to $+85^\circ\text{C}$ unless otherwise specified)

Parameter	Symbol	Conditions	Min.	Typ.	Max.	Unit	Test Circuit	
Output voltage ^{*1}	$V_{OUT(E)}$	$I_{OUT} = 30 \text{ mA}$, $-40^\circ\text{C} \leq T_j \leq +105^\circ\text{C}$	$V_{OUT(S)} \times 0.97$	$V_{OUT(S)}$	$V_{OUT(S)} \times 1.03$	V	1	
Output current ^{*2}	I_{OUT}	$V_{IN} \geq V_{OUT(S)} + 2.0 \text{ V}$	200^{*4}	–	–	mA	3	
Dropout voltage ^{*3}	V_{drop}	$I_{OUT} = 100 \text{ mA}$ $T_a = +25^\circ\text{C}$	$2.0 \text{ V} \leq V_{OUT(S)} < 2.2 \text{ V}$	–	1.0	–	V	1
			$2.2 \text{ V} \leq V_{OUT(S)} < 2.4 \text{ V}$	–	0.8	–	V	1
			$2.4 \text{ V} \leq V_{OUT(S)} < 2.6 \text{ V}$	–	0.6	–	V	1
			$2.6 \text{ V} \leq V_{OUT(S)} < 3.0 \text{ V}$	–	0.45	–	V	1
			$3.0 \text{ V} \leq V_{OUT(S)} < 3.5 \text{ V}$	–	0.35	–	V	1
			$3.5 \text{ V} \leq V_{OUT(S)} < 4.0 \text{ V}$	–	0.3	–	V	1
			$4.0 \text{ V} \leq V_{OUT(S)} < 5.0 \text{ V}$	–	0.27	–	V	1
			$5.0 \text{ V} \leq V_{OUT(S)} < 7.0 \text{ V}$	–	0.23	–	V	1
			$7.0 \text{ V} \leq V_{OUT(S)} < 9.0 \text{ V}$	–	0.2	–	V	1
		$9.0 \text{ V} \leq V_{OUT(S)} \leq 12.0 \text{ V}$	–	0.18	–	V	1	
		$I_{OUT} = 200 \text{ mA}$ $T_a = +25^\circ\text{C}$	$2.0 \text{ V} \leq V_{OUT(S)} < 2.2 \text{ V}$	–	1.12	–	V	1
			$2.2 \text{ V} \leq V_{OUT(S)} < 2.4 \text{ V}$	–	1.02	–	V	1
			$2.4 \text{ V} \leq V_{OUT(S)} < 2.6 \text{ V}$	–	0.92	–	V	1
			$2.6 \text{ V} \leq V_{OUT(S)} < 3.0 \text{ V}$	–	0.82	–	V	1
			$3.0 \text{ V} \leq V_{OUT(S)} < 3.5 \text{ V}$	–	0.72	–	V	1
			$3.5 \text{ V} \leq V_{OUT(S)} < 4.0 \text{ V}$	–	0.62	–	V	1
			$4.0 \text{ V} \leq V_{OUT(S)} < 5.0 \text{ V}$	–	0.55	–	V	1
			$5.0 \text{ V} \leq V_{OUT(S)} < 7.0 \text{ V}$	–	0.5	–	V	1
$7.0 \text{ V} \leq V_{OUT(S)} < 9.0 \text{ V}$	–		0.45	–	V	1		
$9.0 \text{ V} \leq V_{OUT(S)} \leq 12.0 \text{ V}$	–	0.4	–	V	1			
Line regulation	$\frac{\Delta V_{OUT1}}{\Delta V_{IN} \cdot V_{OUT}}$	$V_{OUT(S)} + 1.0 \text{ V} \leq V_{IN} \leq 30 \text{ V}$, $I_{OUT} = 30 \text{ mA}$	–	0.05	0.3	%/V	1	
Load regulation	ΔV_{OUT2}	$V_{IN} = V_{OUT(S)} + 1.0 \text{ V}$, $2.0 \text{ V} \leq V_{OUT(S)} < 5.1 \text{ V}$ $0.1 \text{ mA} \leq I_{OUT} \leq 40 \text{ mA}$	–	20	40	mV	1	
		$V_{IN} = V_{OUT(S)} + 1.0 \text{ V}$, $5.1 \text{ V} \leq V_{OUT(S)} \leq 12.0 \text{ V}$ $0.1 \text{ mA} \leq I_{OUT} \leq 40 \text{ mA}$	–	20	60	mV	1	
Current consumption during operation	I_{SS1}	ON/OFF pin = ON, no load	–	4.0	9.0	μA	2	
Current consumption during shutdown	I_{SS2}	ON/OFF pin = OFF, no load	–	0.1	1.0	μA	2	
Input voltage	V_{IN}	–	3.0	–	50	V	–	
Power-off pin input voltage "H"	V_{SH}	$V_{IN} = V_{OUT(S)} + 1.0 \text{ V}$, $R_L = 1.0 \text{ k}\Omega$, determined by V_{OUT} output level	1.5	–	–	V	4	
Power-off pin input voltage "L"	V_{SL}	$V_{IN} = V_{OUT(S)} + 1.0 \text{ V}$, $R_L = 1.0 \text{ k}\Omega$, determined by V_{OUT} output level	–	–	0.3	V	4	
Power-off pin input current "H"	I_{SH}	$V_{IN} = V_{OUT(S)} + 1.0 \text{ V}$, $V_{ON/OFF} = V_{OUT(S)} + 1.0 \text{ V}$	–0.1	–	0.1	μA	4	
Power-off pin input current "L"	I_{SL}	$V_{IN} = V_{OUT(S)} + 1.0 \text{ V}$, $V_{ON/OFF} = 0 \text{ V}$	–0.1	–	0.1	μA	4	
Ripple rejection	RR	$V_{IN} = V_{OUT(S)} + 1.0 \text{ V}$, $f = 100 \text{ Hz}$, $\Delta V_{rip} = 0.5 \text{ Vrms}$, $I_{OUT} = 30 \text{ mA}$, $T_a = +25^\circ\text{C}$	$2.0 \text{ V} \leq V_{OUT(S)} < 2.3 \text{ V}$	–	50	–	dB	5
			$2.3 \text{ V} \leq V_{OUT(S)} < 3.6 \text{ V}$	–	45	–	dB	5
			$3.6 \text{ V} \leq V_{OUT(S)} < 6.1 \text{ V}$	–	40	–	dB	5
			$6.1 \text{ V} \leq V_{OUT(S)} < 10.1 \text{ V}$	–	35	–	dB	5
$10.1 \text{ V} \leq V_{OUT(S)} \leq 12.0 \text{ V}$	–	30	–	dB	5			
Short-circuit current	I_{SHORT}	$V_{IN} = V_{OUT(S)} + 1.0 \text{ V}$, ON/OFF pin = ON, $V_{OUT} = 0 \text{ V}$, $T_a = +25^\circ\text{C}$	–	80	–	mA	3	
Thermal shutdown detection temperature	T_{SD}	Junction temperature	–	150	–	$^\circ\text{C}$	–	
Thermal shutdown release temperature	T_{SR}	Junction temperature	–	125	–	$^\circ\text{C}$	–	

- *1. $V_{OUT(S)}$: Specified output voltage
 $V_{OUT(E)}$: Actual output voltage
The output voltage when fixing I_{OUT} (= 30 mA) and inputting $V_{OUT(S)} + 1.0$ V
- *2. The output current at which the output voltage becomes 95% of $V_{OUT(E)}$ after gradually increasing the output current.
- *3. $V_{drop} = V_{IN1} - (V_{OUT3} \times 0.98)$
 V_{OUT3} is the output voltage when $V_{IN} = V_{OUT(S)} + 2.0$ V, and $I_{OUT} = 100$ mA or 200 mA.
 V_{IN1} is the input voltage at which the output voltage becomes 98% of V_{OUT3} after gradually decreasing the input voltage.
- *4. The output current can be at least this value.
Due to limitation of the package power dissipation, this value may not be satisfied. Attention should be paid to the power dissipation of the package when the output current is large.
This specification is guaranteed by design.

2. S-1142xxxH (+105°C supported)

Table 7

($V_{IN} = 13.5\text{ V}$, $T_j = -40^\circ\text{C}$ to $+125^\circ\text{C}$, $T_a = -40^\circ\text{C}$ to $+105^\circ\text{C}$ unless otherwise specified)

Parameter	Symbol	Conditions	Min.	Typ.	Max.	Unit	Test Circuit	
Output voltage ^{*1}	$V_{OUT(E)}$	$I_{OUT} = 30\text{ mA}$, $-40^\circ\text{C} \leq T_j \leq +105^\circ\text{C}$	$V_{OUT(S)} \times 0.97$	$V_{OUT(S)}$	$V_{OUT(S)} \times 1.03$	V	1	
Output current ^{*2}	I_{OUT}	$V_{IN} \geq V_{OUT(S)} + 2.0\text{ V}$	200^{*4}	–	–	mA	3	
Dropout voltage ^{*3}	V_{drop}	$I_{OUT} = 100\text{ mA}$ $T_a = +25^\circ\text{C}$	$2.0\text{ V} \leq V_{OUT(S)} < 2.2\text{ V}$	–	1.0	–	V	1
			$2.2\text{ V} \leq V_{OUT(S)} < 2.4\text{ V}$	–	0.8	–	V	1
			$2.4\text{ V} \leq V_{OUT(S)} < 2.6\text{ V}$	–	0.6	–	V	1
			$2.6\text{ V} \leq V_{OUT(S)} < 3.0\text{ V}$	–	0.45	–	V	1
			$3.0\text{ V} \leq V_{OUT(S)} < 3.5\text{ V}$	–	0.35	–	V	1
			$3.5\text{ V} \leq V_{OUT(S)} < 4.0\text{ V}$	–	0.3	–	V	1
			$4.0\text{ V} \leq V_{OUT(S)} < 5.0\text{ V}$	–	0.27	–	V	1
			$5.0\text{ V} \leq V_{OUT(S)} < 7.0\text{ V}$	–	0.23	–	V	1
			$7.0\text{ V} \leq V_{OUT(S)} < 9.0\text{ V}$	–	0.2	–	V	1
		$9.0\text{ V} \leq V_{OUT(S)} \leq 12.0\text{ V}$	–	0.18	–	V	1	
		$I_{OUT} = 200\text{ mA}$ $T_a = +25^\circ\text{C}$	$2.0\text{ V} \leq V_{OUT(S)} < 2.2\text{ V}$	–	1.12	–	V	1
			$2.2\text{ V} \leq V_{OUT(S)} < 2.4\text{ V}$	–	1.02	–	V	1
			$2.4\text{ V} \leq V_{OUT(S)} < 2.6\text{ V}$	–	0.92	–	V	1
			$2.6\text{ V} \leq V_{OUT(S)} < 3.0\text{ V}$	–	0.82	–	V	1
			$3.0\text{ V} \leq V_{OUT(S)} < 3.5\text{ V}$	–	0.72	–	V	1
			$3.5\text{ V} \leq V_{OUT(S)} < 4.0\text{ V}$	–	0.62	–	V	1
			$4.0\text{ V} \leq V_{OUT(S)} < 5.0\text{ V}$	–	0.55	–	V	1
			$5.0\text{ V} \leq V_{OUT(S)} < 7.0\text{ V}$	–	0.5	–	V	1
$7.0\text{ V} \leq V_{OUT(S)} < 9.0\text{ V}$	–		0.45	–	V	1		
$9.0\text{ V} \leq V_{OUT(S)} \leq 12.0\text{ V}$	–	0.4	–	V	1			
Line regulation	$\frac{\Delta V_{OUT1}}{\Delta V_{IN} \cdot V_{OUT}}$	$V_{OUT(S)} + 1.0\text{ V} \leq V_{IN} \leq 30\text{ V}$, $I_{OUT} = 30\text{ mA}$	–	0.05	0.3	%/V	1	
Load regulation	ΔV_{OUT2}	$V_{IN} = 13.5\text{ V}$, $2.0\text{ V} \leq V_{OUT(S)} < 5.1\text{ V}$ $0.1\text{ mA} \leq I_{OUT} \leq 40\text{ mA}$	–	20	70	mV	1	
		$V_{IN} = 13.5\text{ V}$, $5.1\text{ V} \leq V_{OUT(S)} \leq 12.0\text{ V}$ $0.1\text{ mA} \leq I_{OUT} \leq 40\text{ mA}$	–	20	150	mV	1	
Current consumption during operation	I_{SS1}	ON/OFF pin = ON, no load	–	4.0	9.0	μA	2	
Current consumption during shutdown	I_{SS2}	ON/OFF pin = OFF, no load	–	0.1	2.5	μA	2	
Input voltage	V_{IN}	–	3.0	–	50	V	–	
Shutdown pin input voltage "H"	V_{SH}	$V_{IN} = 13.5\text{ V}$, $R_L = 1.0\text{ k}\Omega$, determined by V_{OUT} output level	1.5	–	–	V	4	
Shutdown pin input voltage "L"	V_{SL}	$V_{IN} = 13.5\text{ V}$, $R_L = 1.0\text{ k}\Omega$, determined by V_{OUT} output level	–	–	0.3	V	4	
Shutdown pin input current "H"	I_{SH}	$V_{IN} = 13.5\text{ V}$, $V_{ON/OFF} = 13.5\text{ V}$	–0.1	–	0.1	μA	4	
Shutdown pin input current "L"	I_{SL}	$V_{IN} = 13.5\text{ V}$, $V_{ON/OFF} = 0\text{ V}$	–0.1	–	0.1	μA	4	
Ripple rejection	RR	$V_{IN} = 13.5\text{ V}$, $f = 100\text{ Hz}$, $\Delta V_{rip} = 0.5\text{ Vrms}$, $I_{OUT} = 30\text{ mA}$, $T_a = +25^\circ\text{C}$	$2.0\text{ V} \leq V_{OUT(S)} < 2.3\text{ V}$	–	50	–	dB	5
			$2.3\text{ V} \leq V_{OUT(S)} < 3.6\text{ V}$	–	45	–	dB	5
			$3.6\text{ V} \leq V_{OUT(S)} < 6.1\text{ V}$	–	40	–	dB	5
			$6.1\text{ V} \leq V_{OUT(S)} < 10.1\text{ V}$	–	35	–	dB	5
			$10.1\text{ V} \leq V_{OUT(S)} \leq 12.0\text{ V}$	–	30	–	dB	5
Short-circuit current	I_{SHORT}	$V_{IN} = 13.5\text{ V}$, ON/OFF pin = ON, $V_{OUT} = 0\text{ V}$, $T_a = +25^\circ\text{C}$	–	80	–	mA	3	
Thermal shutdown detection temperature	T_{SD}	Junction temperature	–	150	–	$^\circ\text{C}$	–	
Thermal shutdown release temperature	T_{SR}	Junction temperature	–	125	–	$^\circ\text{C}$	–	

- *1. $V_{OUT(S)}$: Specified output voltage
 $V_{OUT(E)}$: Actual output voltage
The output voltage when fixing I_{OUT} (= 30 mA) and inputting 13.5 V
- *2. The output current at which the output voltage becomes 95% of $V_{OUT(E)}$ after gradually increasing the output current.
- *3. $V_{drop} = V_{IN1} - (V_{OUT3} \times 0.98)$
 V_{OUT3} is the output voltage when $V_{IN} = V_{OUT(S)} + 2.0$ V, and $I_{OUT} = 100$ mA or 200 mA.
 V_{IN1} is the input voltage at which the output voltage becomes 98% of V_{OUT3} after gradually decreasing the input voltage.
- *4. The output current can be at least this value.
Due to limitation of the package power dissipation, this value may not be satisfied. Attention should be paid to the power dissipation of the package when the output current is large.
This specification is guaranteed by design.

■ Test Circuit

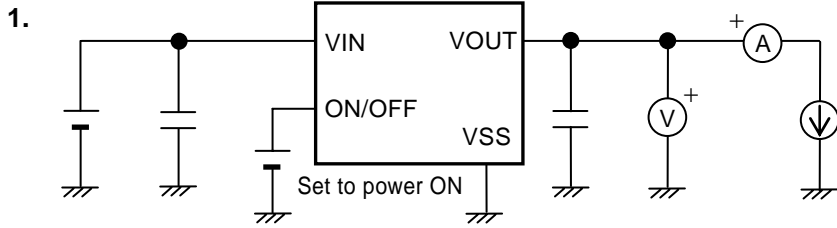

Figure 5

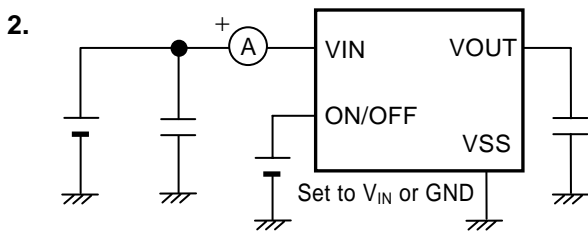

Figure 6

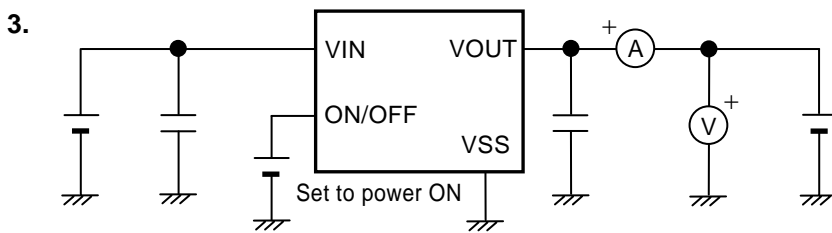

Figure 7

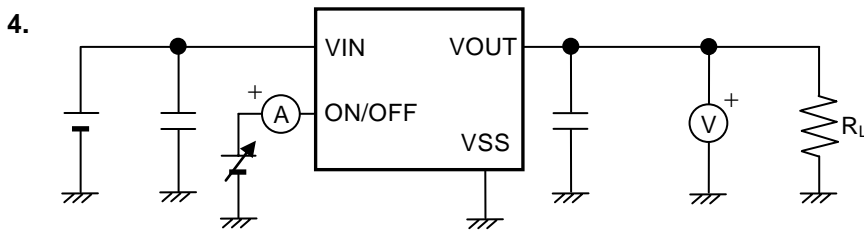

Figure 8

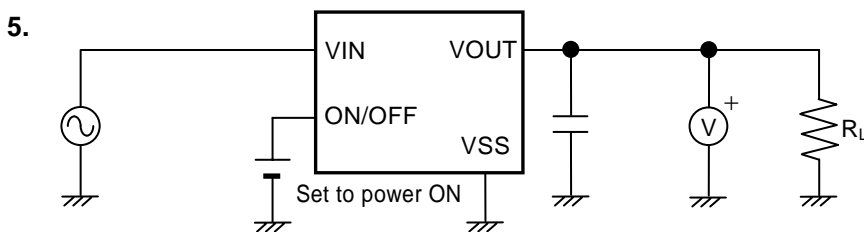
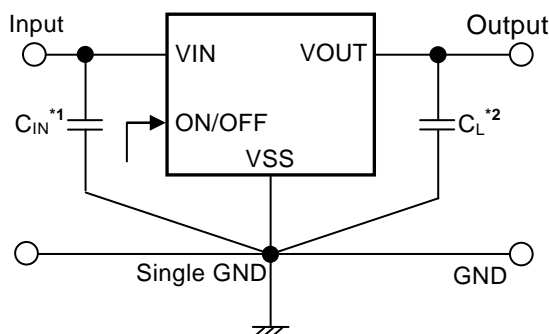

Figure 9

■ Standard Circuit



*1. C_{IN} is a capacitor for stabilizing the input.

*2. Ceramic capacitor of 0.1 μF or more can be used as C_L .

Figure 10

Caution The above connection diagram and constants will not guarantee successful operation. Perform thorough evaluation using an actual application to set the constants.

■ Application Conditions

Input capacitor (C_{IN}) : 0.1 μF or more

Output capacitor (C_L) : 0.1 μF or more (ceramic capacitor)

Caution Generally, series regulator may oscillate depending on the external components. Confirm that no oscillation occur in the application for which the above capacitors are used.

■ Selection of Input and Output Capacitors (C_{IN} , C_L)

The S-1142 Series requires an output capacitor between the VOUT and VSS pins for phase compensation. Operation is stabilized by a ceramic capacitor with an output capacitance of 0.1 μF or more over the entire temperature range. When using an OS capacitor, a tantalum capacitor, or an aluminum electrolytic capacitor, the capacitance must be 0.1 μF or more.

The values of output overshoot and undershoot, which are transient response characteristics, vary depending on the value of the output capacitor.

The required value of capacitance for the input capacitor differs depending on the application.

Set the value for input capacitor (C_{IN}) and output capacitor (C_L) as follows.

$$C_{IN} \geq 0.1 \mu\text{F}$$

$$C_L \geq 0.1 \mu\text{F}$$

Caution Define the capacity values of C_{IN} and C_L by sufficient evaluation including the temperature characteristics under the actual usage conditions.

■ Explanation of Terms

1. Low dropout voltage regulator

A voltage regulator which has a low dropout voltage due to its built-in low on-resistance transistor.

2. Output voltage (V_{OUT})

The accuracy of the output voltage is ensured at $\pm 3.0\%$ under specified conditions of fixed input voltage^{*1}, fixed output current, and fixed temperature.

*1. Differs depending on the product.

Caution If the above conditions change, the output voltage value may vary and exceed the accuracy range of the output voltage. Refer to “■ Electrical Characteristics” and “■ Characteristics (Typical Data)” for details.

3. Line regulation $\left(\frac{\Delta V_{OUT1}}{\Delta V_{IN} \bullet V_{OUT}} \right)$

Indicates the dependency of the output voltage against the input voltage. That is, the value shows how much the output voltage changes due to a change in the input voltage after fixing output current constant.

4. Load regulation (ΔV_{OUT2})

Indicates the dependency of the output voltage against the output current. That is, the value shows how much the output voltage changes due to a change in the output current after fixing input voltage constant.

5. Dropout voltage (V_{drop})

Indicates the difference between the output voltage and the input voltage V_{IN1} , which is the input voltage (V_{IN}) when decreasing input voltage V_{IN} gradually until the output voltage has dropped to the value of 98% of output voltage V_{OUT3} , which is at $V_{IN} = V_{OUT(S)} + 2.0$ V.

$$V_{drop} = V_{IN1} - (V_{OUT3} \times 0.98)$$

■ **Operation**

1. Basic operation

Figure 11 shows a block diagram of the S-1142 Series.

The error amplifier compares the reference voltage (V_{ref}) with V_{fb} , which is the output voltage resistance-divided by feedback resistors R_s and R_f . It supplies a gate voltage necessary to maintain a constant output voltage which is not influenced by the input voltage and temperature change to the output transistor.

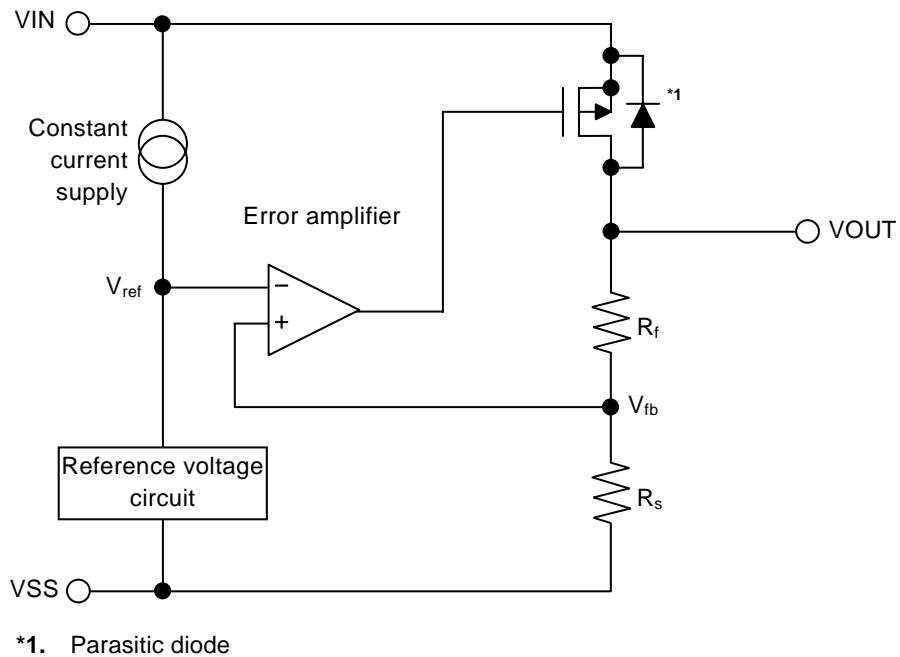

Figure 11

2. Output transistor

In the S-1142 Series, a low on-resistance P-channel MOSFET is used as the output transistor.

Be sure that V_{OUT} does not exceed $V_{IN} + 0.3$ V, to prevent the voltage regulator from being damaged due to inverse current which flows, because of a parasitic diode between the V_{IN} and V_{OUT} pins, when the potential of V_{OUT} becomes higher than V_{IN} .

3. Shutdown pin (ON/OFF pin)

This pin starts and stops the regulator.

When the ON/OFF pin is set to the shutdown level, the entire internal circuit stops operating, and the built-in P-channel MOS FET output transistor between the VIN and VOUT pins is turned off, in order to reduce the current consumption significantly. The VOUT pin is set to the V_{SS} level by the internal dividing resistor of several MΩ between the VOUT and VSS pins.

Note that the current consumption increases when a voltage of 0.3 V to V_{IN} – 0.3 V is applied to the ON/OFF pin.

The ON/OFF pin is configured as shown in **Figure 12**. Since the ON/OFF pin is neither pulled down nor pulled up internally, do not use it in the floating state. When not using the ON/OFF pin, connect it to the VSS pin in the product A type, and connect it to the VIN pin in the B type.

Table 8

Logic Type	ON/OFF Pin	Internal Circuits	VOUT Pin Voltage	Current Consumption
A	“L”: Power on	Operate	Set value	I _{SS1}
A	“H”: Power off	Stop	V _{SS} level	I _{SS2}
B	“L”: Power off	Stop	V _{SS} level	I _{SS2}
B	“H”: Power on	Operate	Set value	I _{SS1}

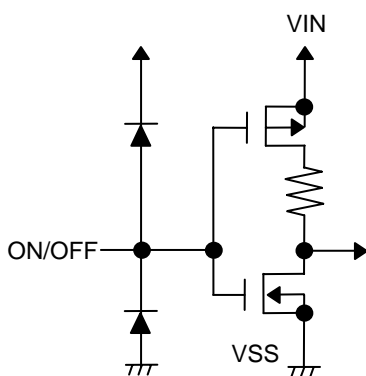

Figure 12

4. Overcurrent protector

The S-1142 Series has an overcurrent protection circuit having the characteristics shown in **(1) Output Voltage vs. Output Current (When load current is increased) (T_a = +25°C)** in “**■ Characteristics (Typical Data)**”, in order to protect the output transistor against an excessive output current and short circuiting between the VOUT and VSS pin. The current (I_{SHORT}) when the output pin is short-circuited is internally set at approx. 80 mA (typ.), and the initial value is restored for the output voltage, if releasing a short circuit once.

Caution Using the overcurrent protection circuit is to protect the output transistor from accidental conditions such as short circuited load and the rapid and large current flow in the large capacitor. The overcurrent protection circuit is not suitable for use under the short circuit status or large current flowing (200 mA or more) that last long.

5. Thermal shutdown circuit

The S-1142 Series has a thermal shutdown circuit to protect the device from damage due to overheat. When the junction temperature rises to 150°C (Typ.), the thermal shutdown circuit operates to stop regulating. When the junction temperature drops to 125°C (Typ.), the thermal shutdown circuit is released to restart regulating.

Due to self-heating of the S-1142 Series, if the thermal shutdown circuit starts operating, it stops regulating so that the output voltage drops. When regulation stops, the S-1142 Series does not itself generate heat and the IC's temperature drops. When the temperature drops, the thermal shutdown circuit is released to restart regulating, thus this IC generates heat again. Repeating this procedure makes the waveform of the output voltage into a pulse-like form. Stop or restart of regulation continues unless decreasing either both of the input voltage and the output voltage in order to reduce the internal current consumption, or decreasing the ambient temperature.

Table 9

Thermal Shutdown Circuit	VOUT Pin Voltage
Operate : 150°C (Typ.) ^{*1}	V _{SS} level
Release : 125°C (Typ.) ^{*1}	Set value

*1. Junction temperature

■ Precautions

- Wiring patterns for the VIN, VOUT and GND pins should be designed so that the impedance is low. When mounting an output capacitor between the VOUT and VSS pins (C_L) and a capacitor for stabilizing the input between the VIN and VSS pins (C_{IN}), the distance from the capacitors to these pins should be as short as possible.
- Note that the output voltage may generally increase when a series regulator is used at low load current (0.1 mA or less).
- Note that the output voltage may generally increase due to the leakage current from a driver when a series regulator is used at a high temperature.
- Note that the output voltage may increase due to the leakage current from a driver even if the ON/OFF pin is at the power-off level when a series regulator is used at a high temperature.
- Generally series regulators may oscillate, depending on the selection of external parts. The following conditions are recommended for this IC. However, be sure to perform sufficient evaluation under the actual usage conditions for selection, including the temperature characteristics. Regarding the equivalent series resistance (R_{ESR}) for the output capacitor, refer to **(6) Example of Equivalent Series Resistance vs. Output Current Characteristics ($T_a = +25^\circ\text{C}$)** in “■ Reference Data”.

Input capacitor (C_{IN}) : 0.1 μF or more

Output capacitor (C_L) : 0.1 μF or more

- The voltage regulator may oscillate when the impedance of the power supply is high and the input capacitance of the IC is small, or an input capacitor is not connected.
- It is important to sufficiently evaluate in an actual device output voltage fluctuations caused by power supply or load fluctuations.
- A momentary overshoot may be output when the power supply suddenly increases, and the output capacitance is small. It is therefore important to sufficiently evaluate the output voltage at power application in actual device.
- The application conditions for the input voltage, output voltage, and load current should not exceed power dissipation of the package.
- Do not apply an electrostatic discharge to this IC that exceeds the performance ratings of the built-in electrostatic protection circuit.
- In determining the output current, attention should be paid to the output current value specified in **Table 6** and **Table 7** in “■ Electrical Characteristics” and footnote *4 of the table.
- SII claims no responsibility for any disputes arising out of or in connection with any infringement by products including this IC of patents owned by a third party.

■ Characteristics (Typical Data)

1. Common to S-1142xxxL and S-1142xxxH

(1) Output Voltage vs. Output Current (when load current is increased) (Ta = +25°C)

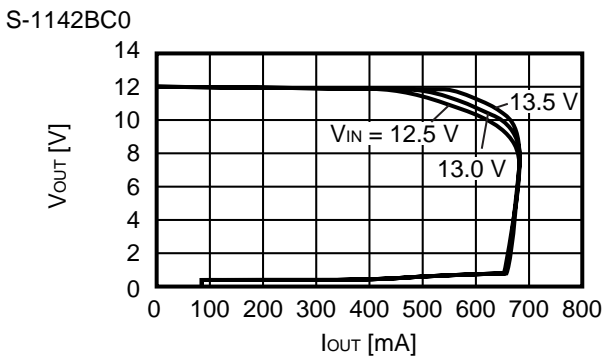
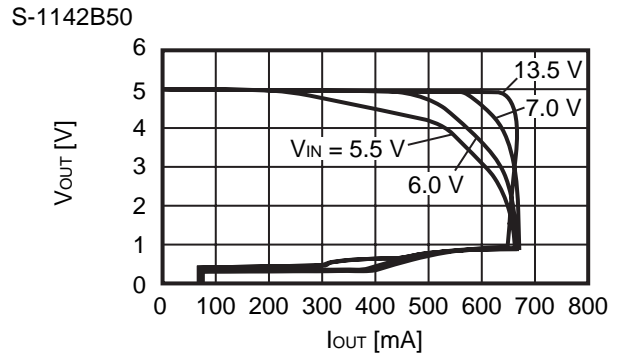
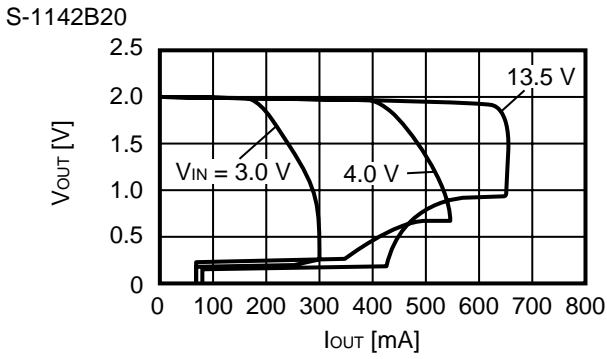

Remark In determining the output current, attention should be paid to the following.

1. The minimum value of output current value and footnote *4 in Table 6 and 7 in the “■ Electrical Characteristics”
2. Power dissipation of the package

(2) Output Voltage vs. Input Voltage (Ta = +25°C)

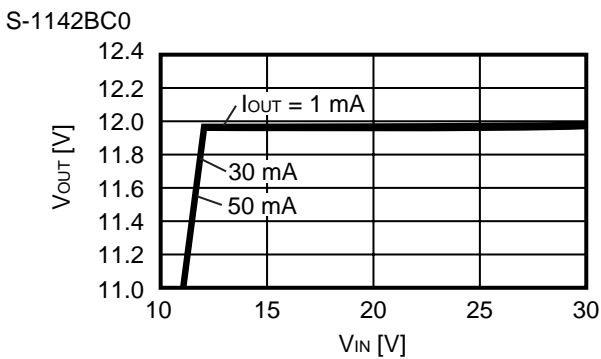
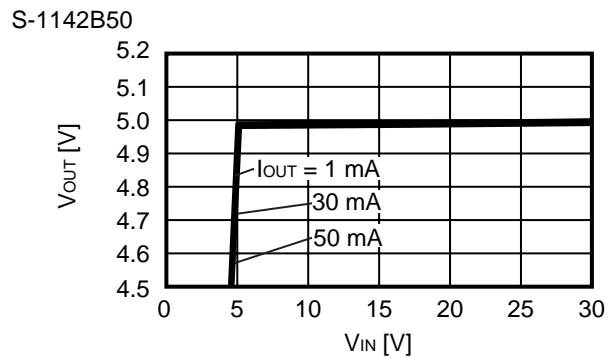
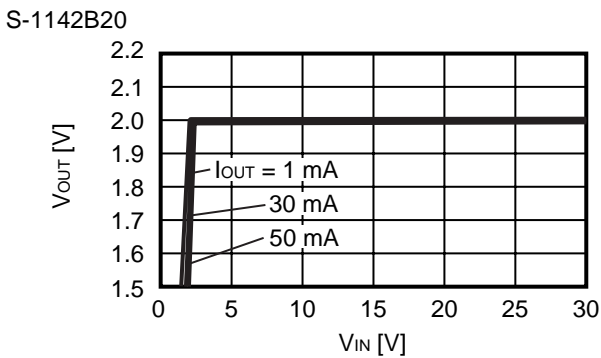

(3) Dropout Voltage vs. Output Current

S-1142B20

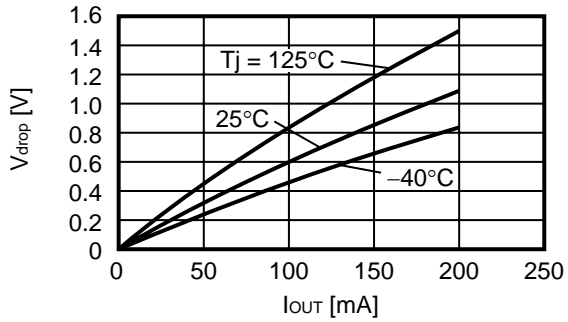

S-1142B50

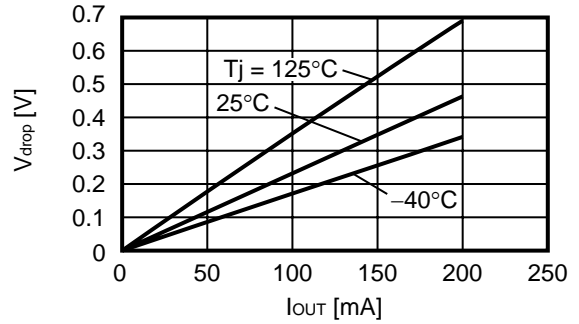

S-1142BC0

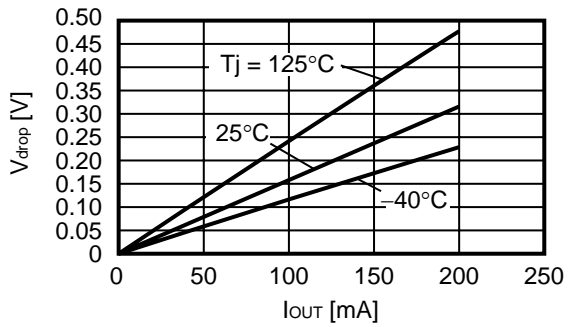

(4) Dropout Voltage vs. Temperature

S-1142B20

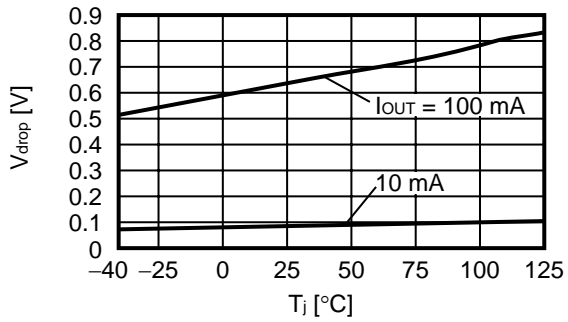

S-1142B50

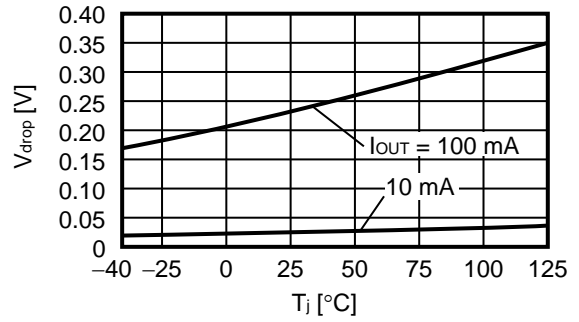

S-1142BC0

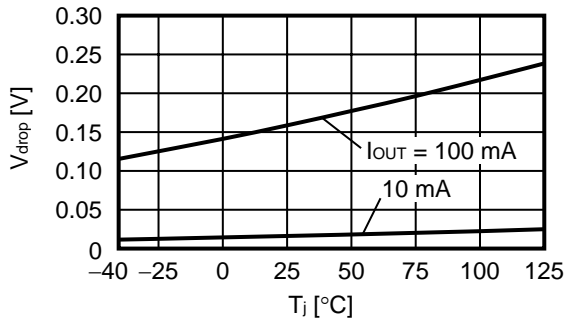

(5) Dropout Voltage vs. Set Output Voltage ($T_j = +25^\circ\text{C}$)

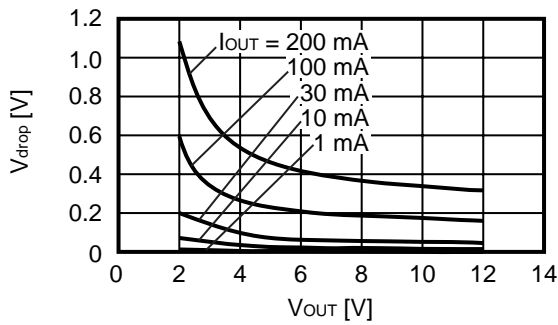

(6) Current Consumption during Operation vs. Input Voltage (When ON/OFF pin is ON, no load)

S-1142B20

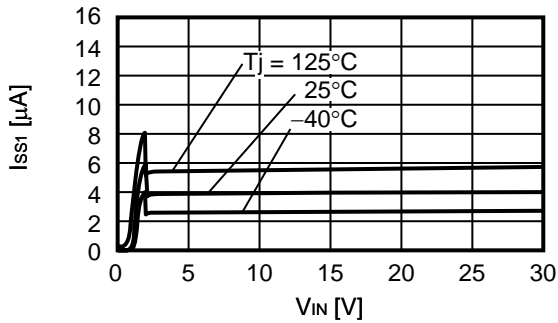

S-1142B50

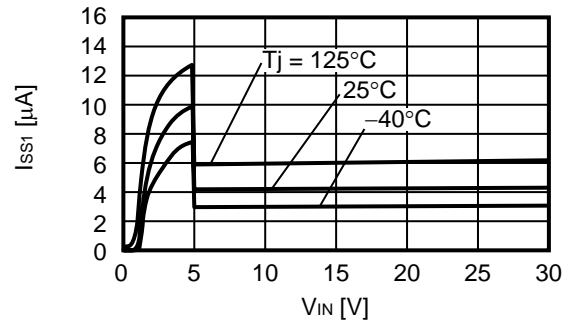

S-1142BC0

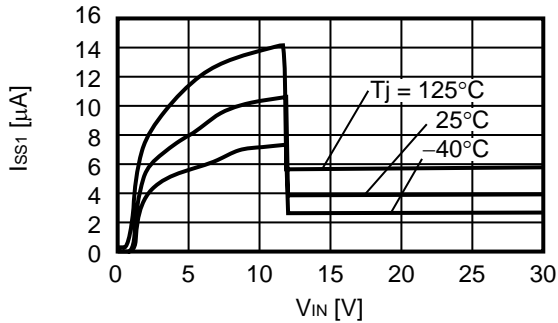

(7) Current Consumption during Operation vs. Output Current (Ta = +25°C)

S-1142B20

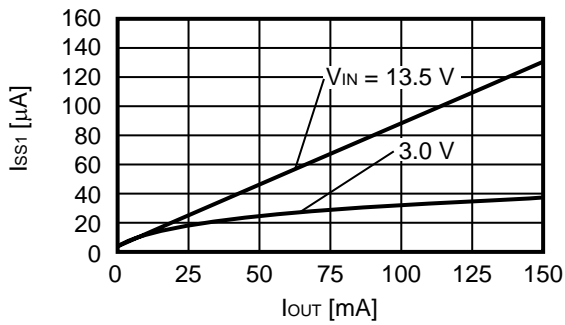

S-1142B50

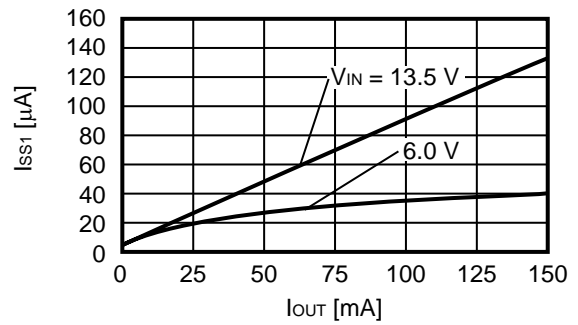

S-1142BC0

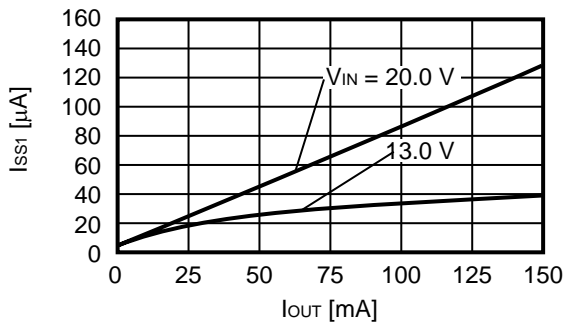

(8) Ripple Rejection (Ta = +25°C)

S-1142B20

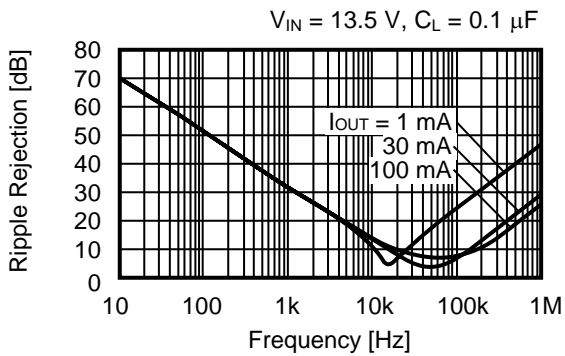

S-1142B50

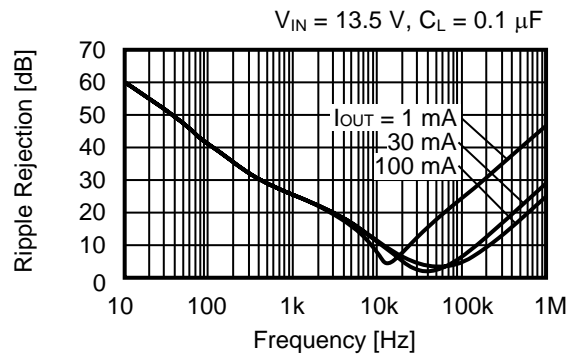

S-1142BC0

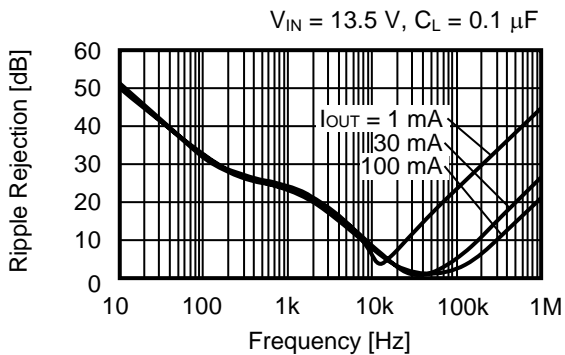

2. S-1142xxxI

(1) Output Voltage vs. Temperature

S-1142B20

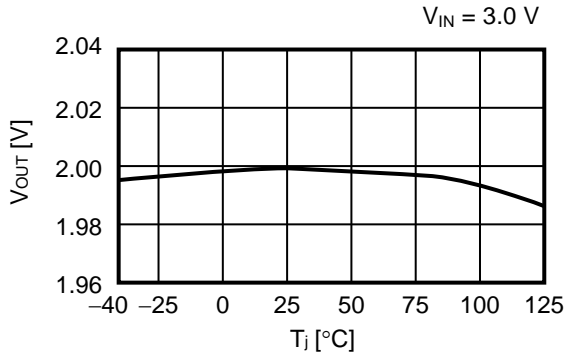

S-1142B50

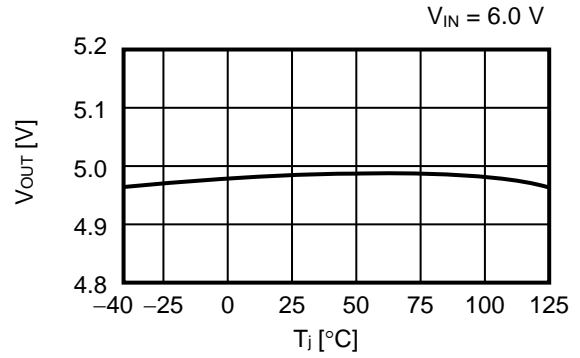

S-1142BC0

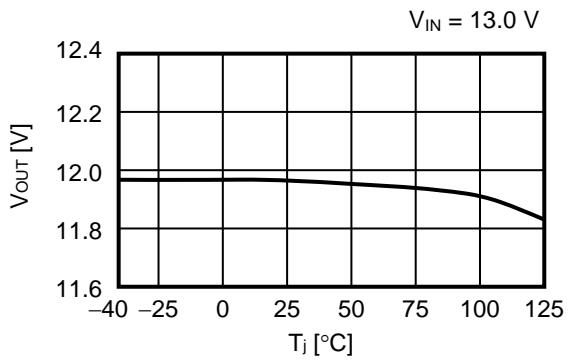

(2) Current Consumption during Operation vs. Temperature

S-1142B20

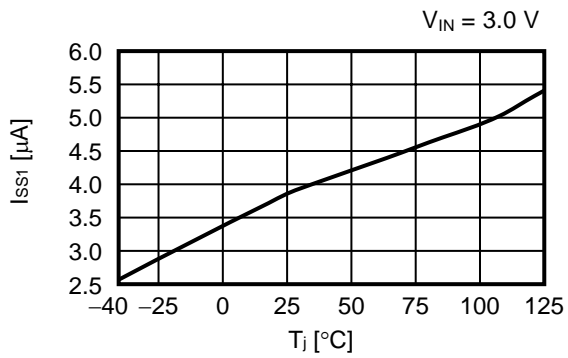

S-1142B50

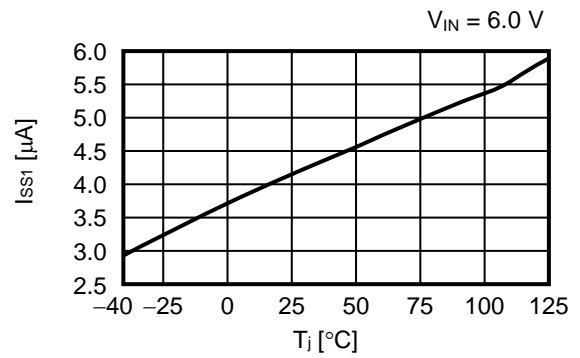

S-1142BC0

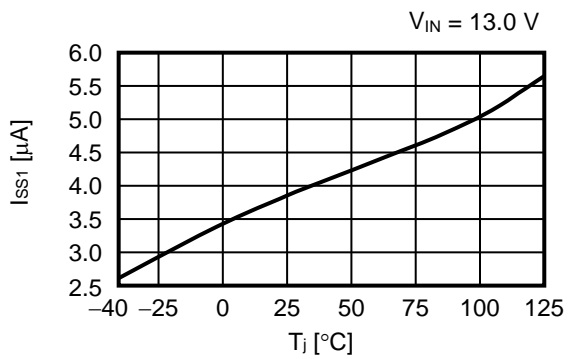

(3) Output Current vs. Input Voltage*1

S-1142B33

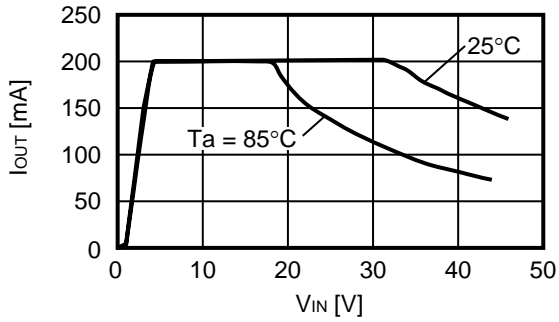

S-1142B50

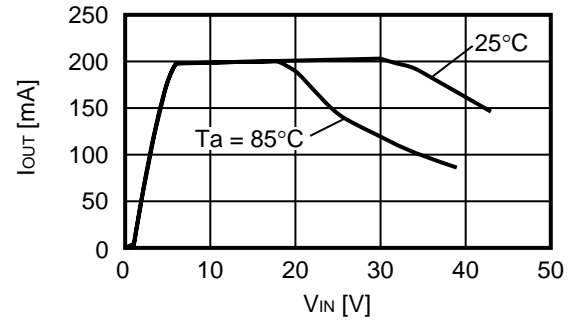

*1. When mounted on board

[Mounted board]

- (1) Board size : 50 mm × 50 mm × t1.6 mm
- (2) Board material : Glass epoxy resin (two layers)
- (3) Wiring ratio : Surface approx. 75%, reverse side approx. 90%
- (4) Hole : Diameter 0.5 mm × 24 pieces

3. S-1142xxxH

(1) Output Voltage vs. Temperature

S-1142B20

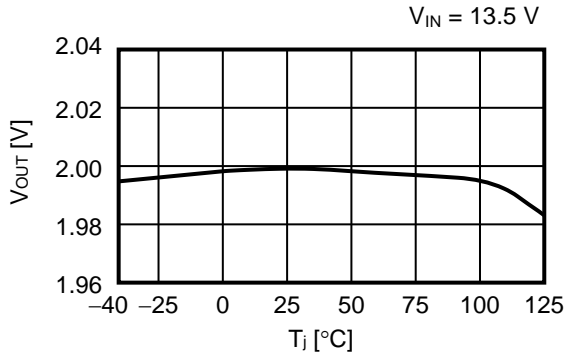

S-1142B50

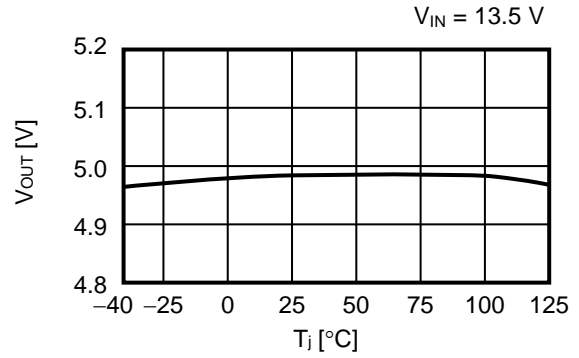

S-1142BC0

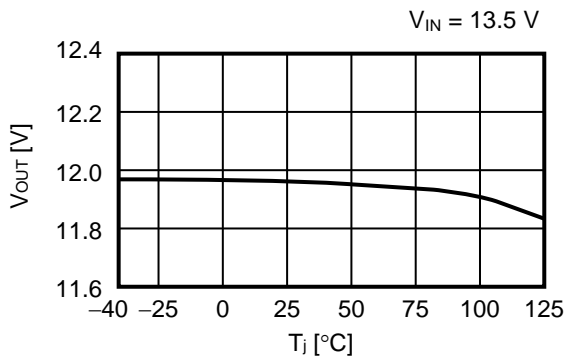

(2) Current Consumption during Operation vs. Temperature

S-1142B20

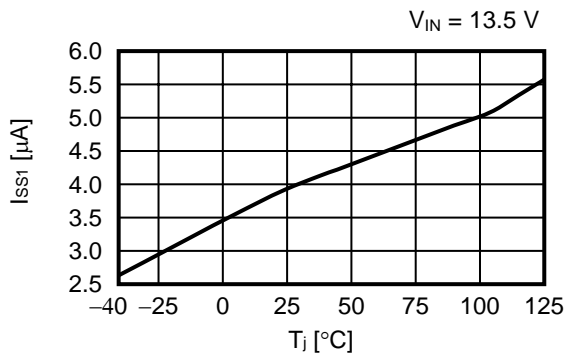

S-1142B50

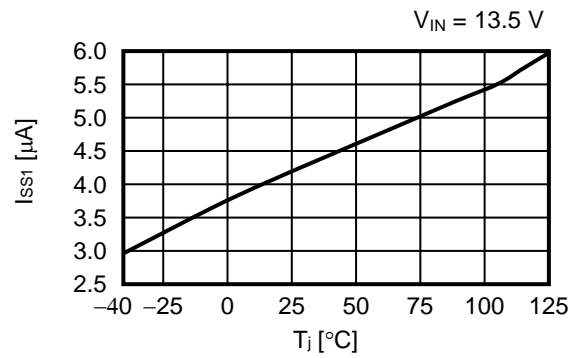

S-1142BC0

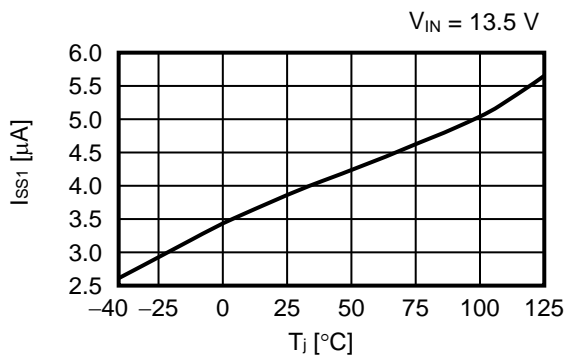

(3) Output Current vs. Input Voltage*1

S-1142B33

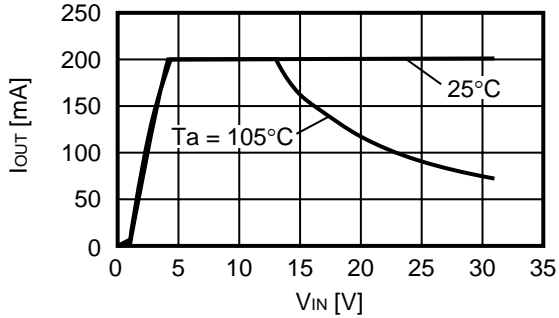

S-1142B50

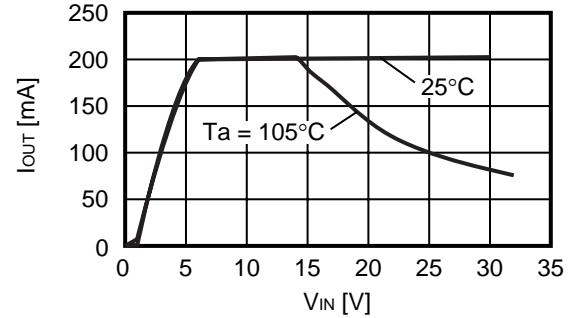

*1. When mounted on board

[Mounted board]

- (1) Board size : 50 mm × 50 mm × t1.6 mm
- (2) Board material : Glass epoxy resin (two layers)
- (3) Wiring ratio : Surface approx. 75%, reverse side approx. 90%
- (4) Hole : Diameter 0.5 mm × 24 pieces

■ Reference Data

(1) Characteristics of Input Transient Response (Ta = +25°C)

S-1142B20

I_{OUT} = 30 mA, tr = tf = 5.0 μs, C_{IN} = 0.1 μF

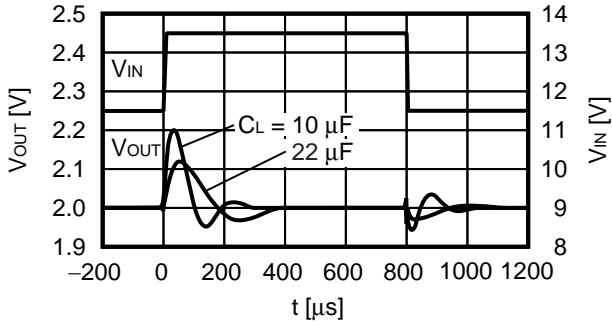

S-1142B50

I_{OUT} = 30 mA, tr = tf = 5.0 μs, C_{IN} = 0.1 μF

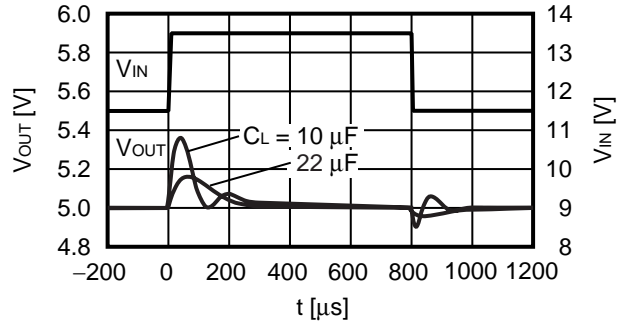

S-1142BC0

I_{OUT} = 30 mA, tr = tf = 5.0 μs, C_{IN} = 0.1 μF

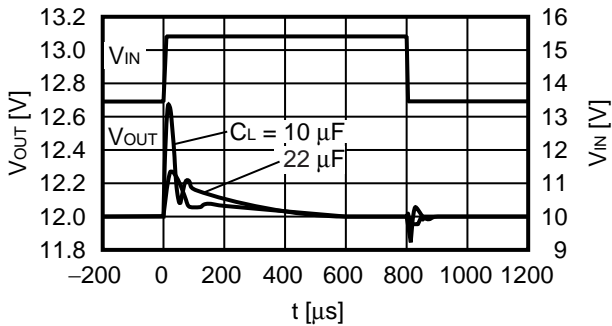

(2) Characteristics of Load Transient Response (Ta = +25°C)

S-1142B20

V_{IN} = 13.5 V, C_{IN} = 0.1 μF, I_{OUT} = 50 mA ↔ 100 mA

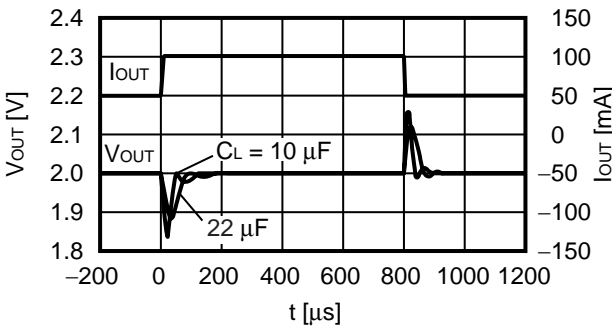

S-1142B50

V_{IN} = 13.5 V, C_{IN} = 0.1 μF, I_{OUT} = 50 mA ↔ 100 mA

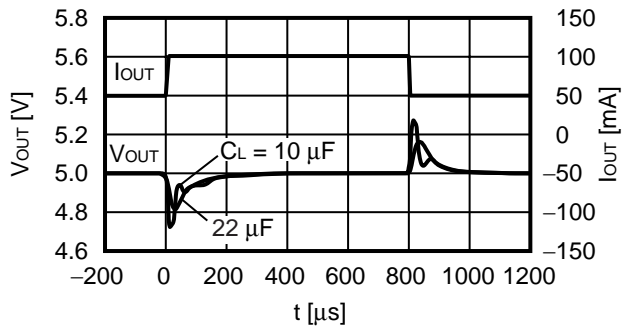

S-1142BC0

V_{IN} = 13.5 V, C_{IN} = 0.1 μF, I_{OUT} = 50 mA ↔ 100 mA

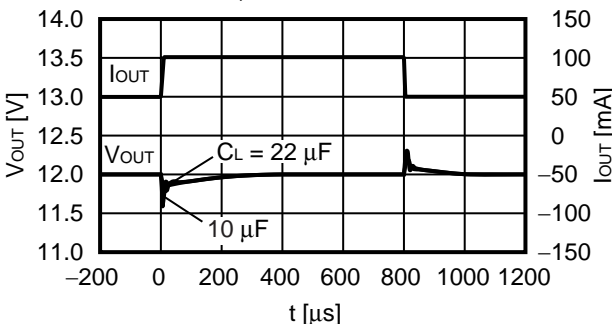

(3) Transient Response Characteristics of ON/OFF Pin (Ta = +25°C)

S-1142B33

V_{IN} = 13.5 V, C_L = 10 μF, C_{IN} = 0.1 μF, I_{OUT} = 100 mA

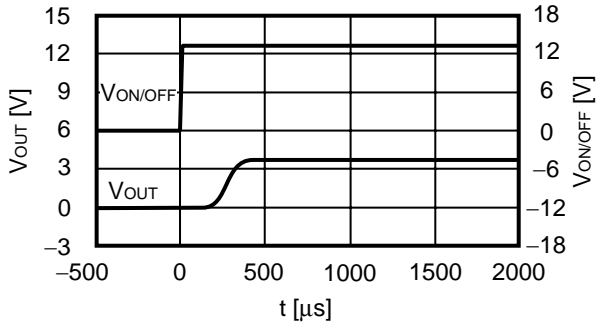

S-1142B50

V_{IN} = 13.5 V, C_L = 10 μF, C_{IN} = 0.1 μF, I_{OUT} = 100 mA

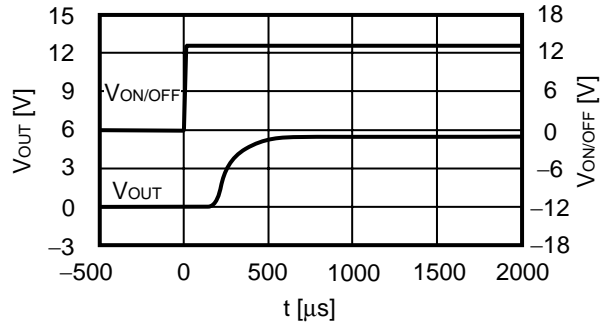

(4) Load Transient Response Characteristics Dependent on Capacitance (Ta = +25°C)

S-1142B50

V_{IN} = 13.5 V, C_{IN} = 0.1 μF, I_{OUT} = 50 mA → 100 mA

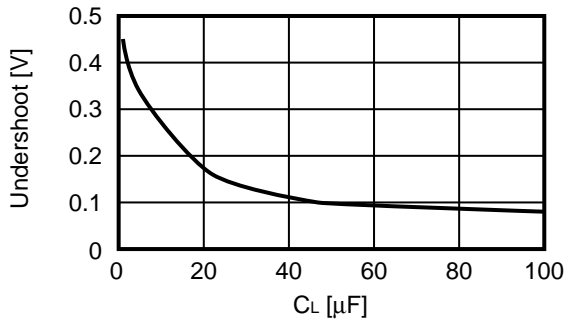

V_{IN} = 13.5 V, C_{IN} = 0.1 μF, I_{OUT} = 100 mA → 50 mA

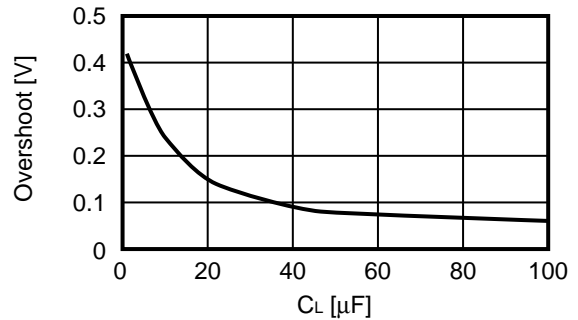

(5) Input Transient Response Characteristics Dependent on Capacitance (Ta = +25°C)

S-1142B50

V_{IN} = 7 V → 12 V, t_r = 5.0 μs, C_{IN} = 0.1 μF, I_{OUT} = 30 mA

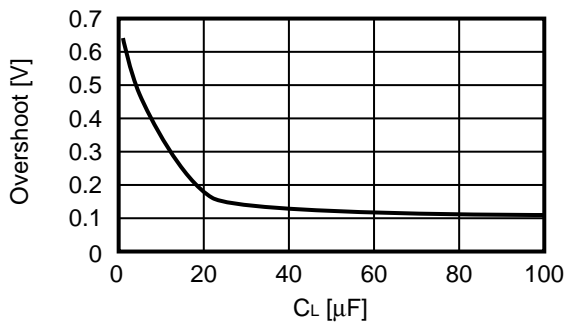

V_{IN} = 12 V → 7 V, t_r = 5.0 μs, C_{IN} = 0.1 μF, I_{OUT} = 30 mA

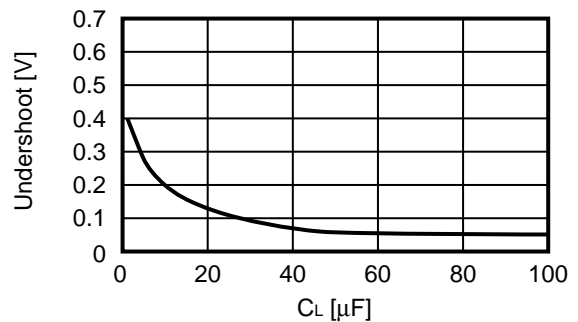

(6) Example of Equivalent Series Resistance vs. Output Current Characteristics (Ta = +25°C)

C_L : TDK Corporation C3216X8R2A104K (0.1 μF)

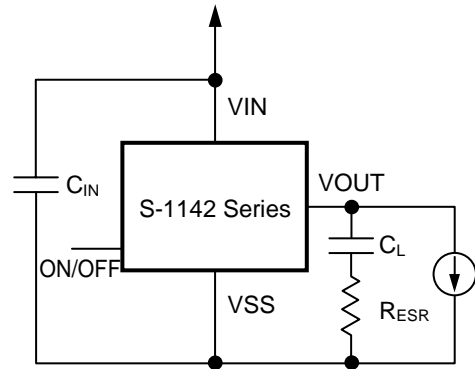
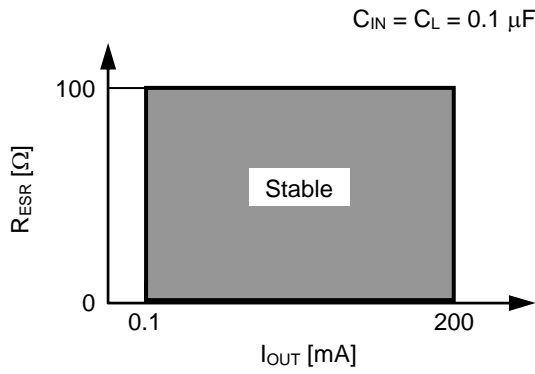

■ Marking Specifications

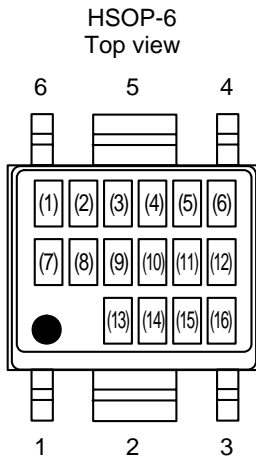

- (1) to (5) : Product name : S1142 (Fixed)
- (6) : Product type
- (7) and (8) : Value of output voltage
- (9) : Operating temperature
- (10) to (16) : Lot number

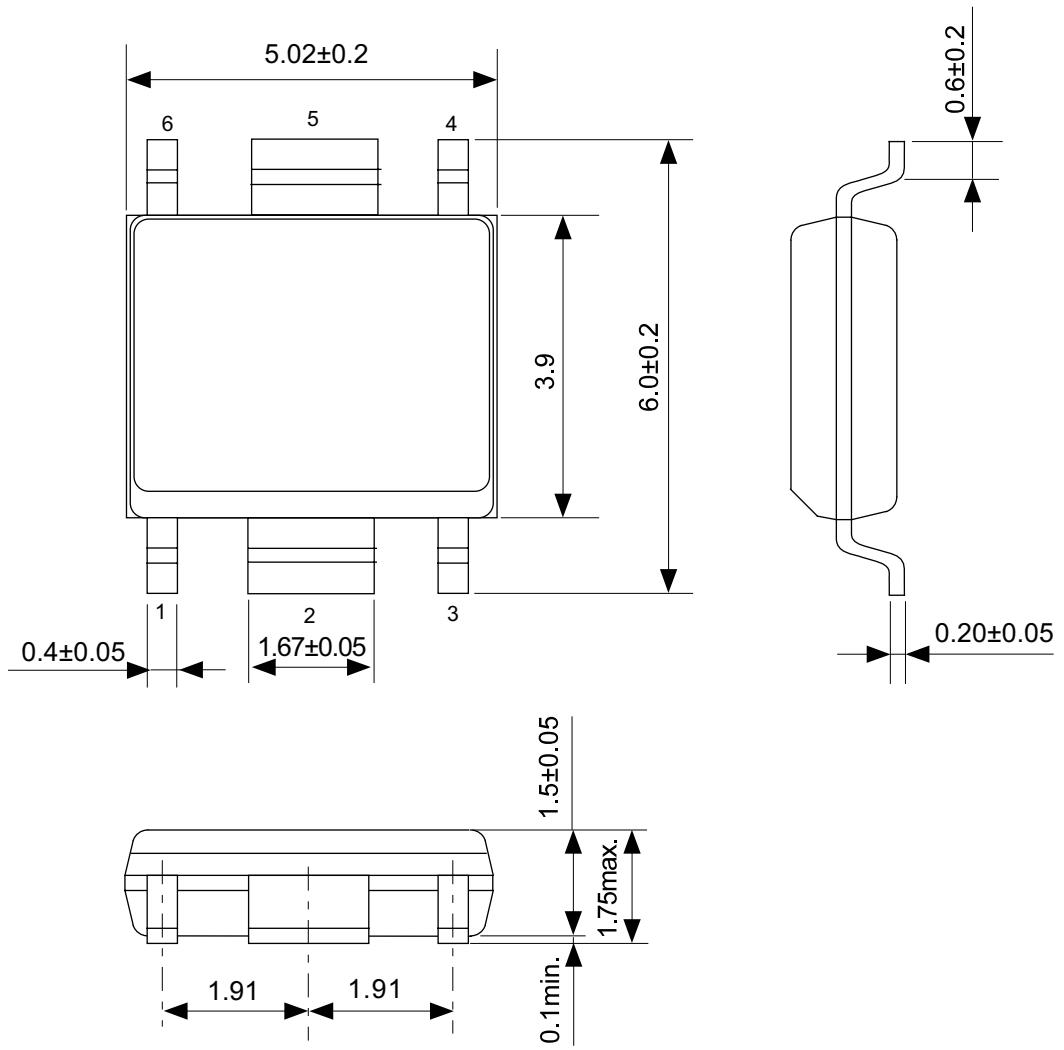

No. FH006-A-P-SD-2.0

TITLE	HSOP6-A-PKG Dimensions
No.	FH006-A-P-SD-2.0
SCALE	
UNIT	mm
Seiko Instruments Inc.	

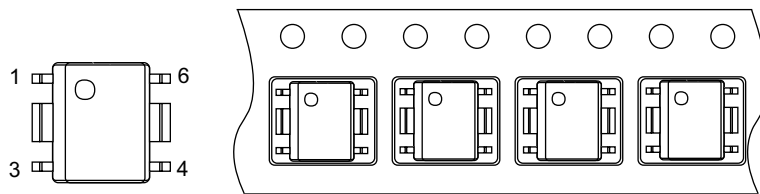
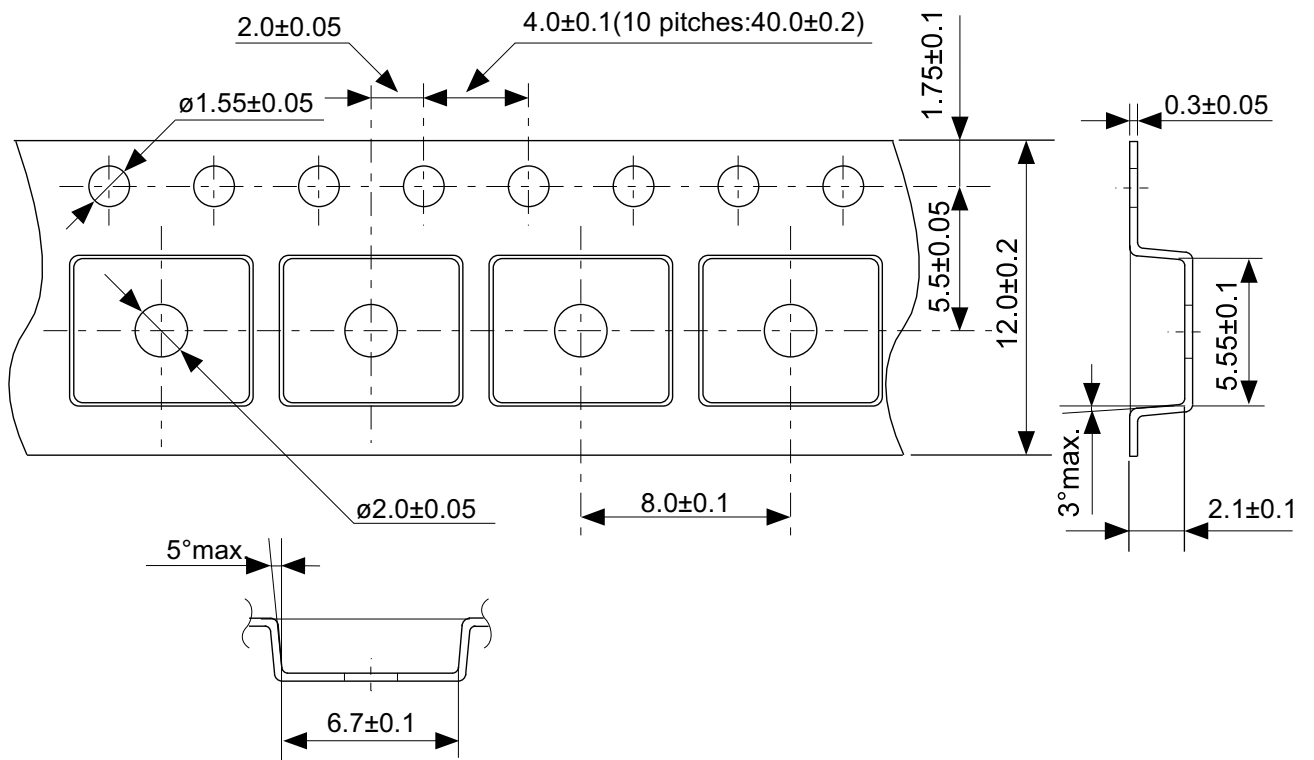

No. FH006-A-C-SD-1.0

TITLE	HSOP6-A-Carrier Tape
No.	FH006-A-C-SD-1.0
SCALE	
UNIT	mm
Seiko Instruments Inc.	

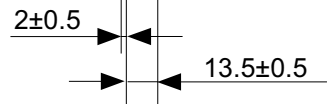
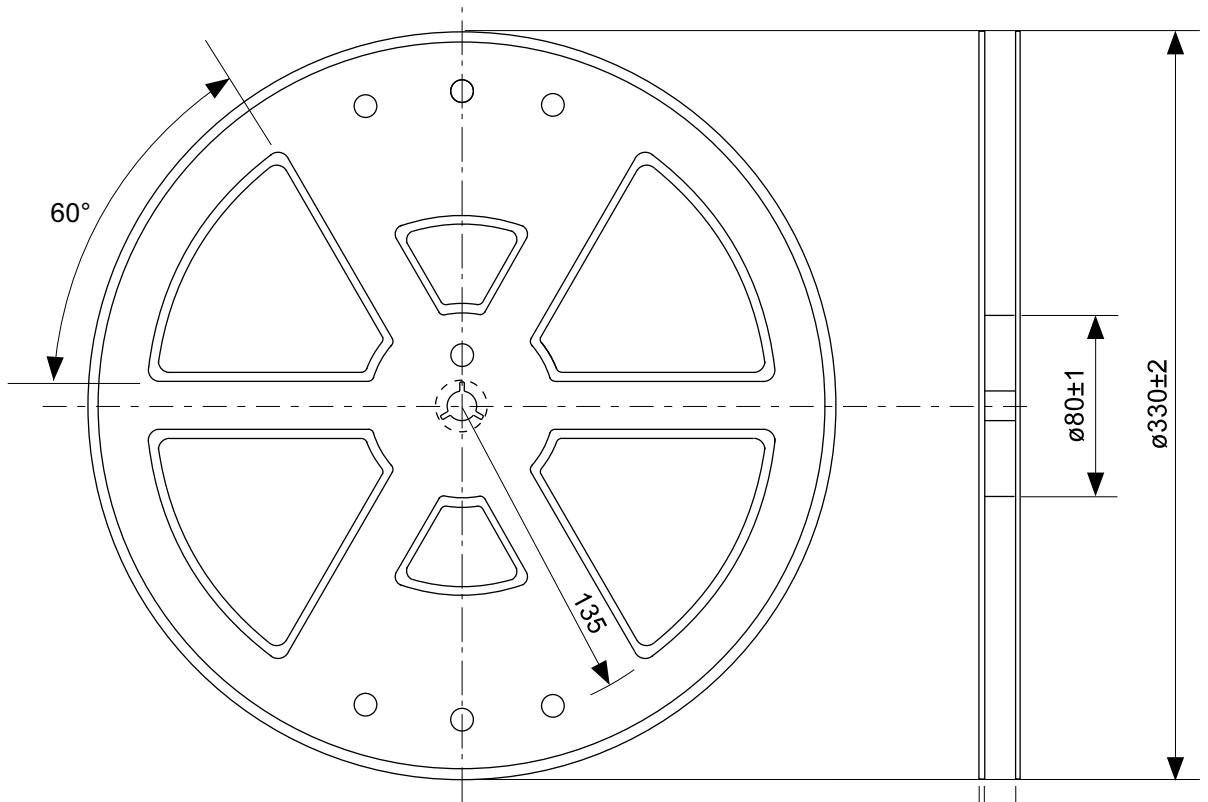

Enlarged drawing in the central part

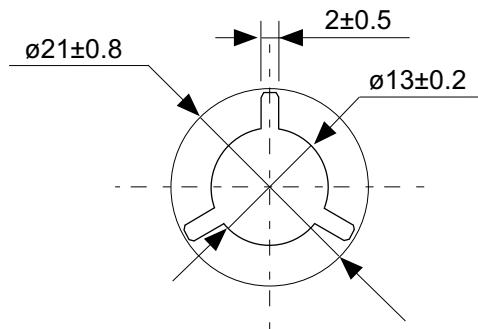

No. FH006-A-R-SD-1.0

TITLE	HSOP6-A-Reel		
No.	FH006-A-R-SD-1.0		
SCALE		QTY.	2,000
UNIT	mm		
Seiko Instruments Inc.			

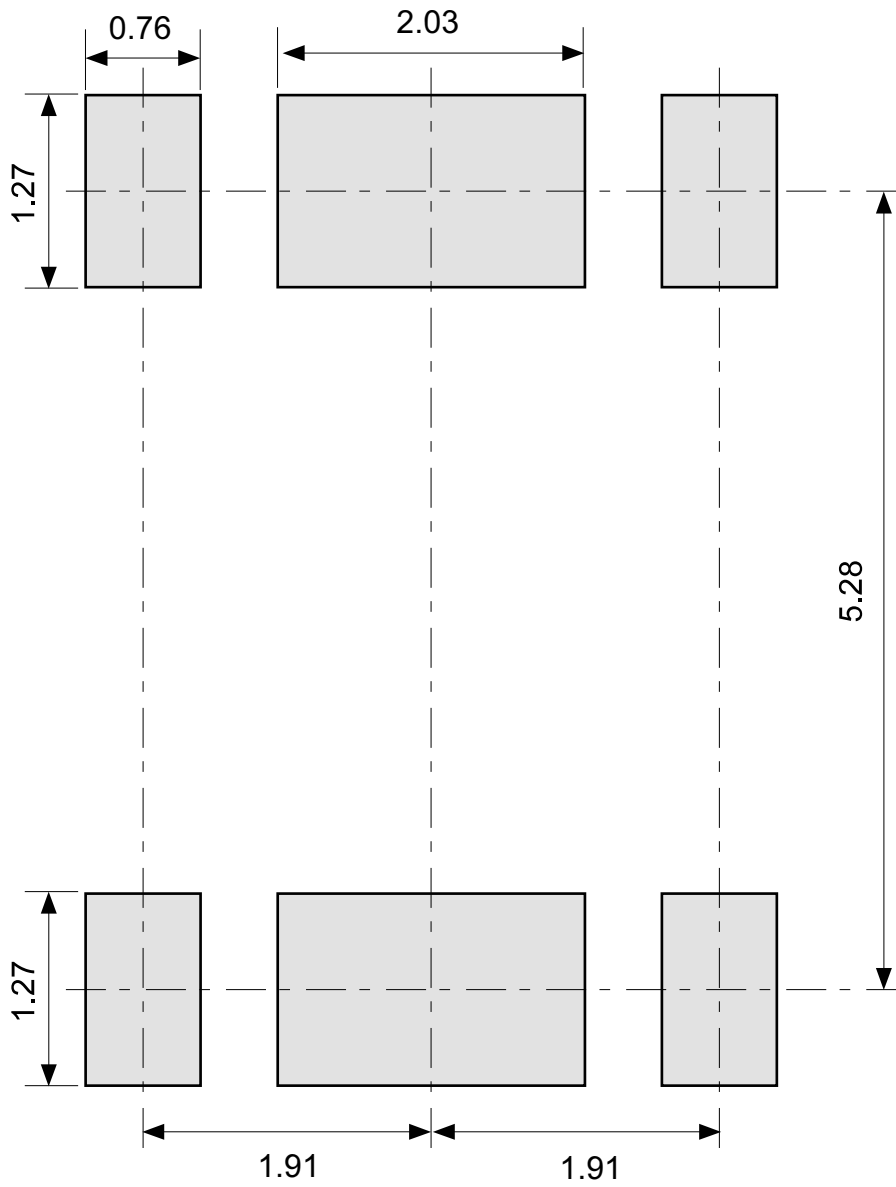

No. FH006-A-L-SD-2.0

TITLE	HSOP6-A-Land Recommendation
No.	FH006-A-L-SD-2.0
SCALE	
UNIT	mm
Seiko Instruments Inc.	



Seiko Instruments Inc.
www.sii-ic.com

- The information described herein is subject to change without notice.
- Seiko Instruments Inc. is not responsible for any problems caused by circuits or diagrams described herein whose related industrial properties, patents, or other rights belong to third parties. The application circuit examples explain typical applications of the products, and do not guarantee the success of any specific mass-production design.
- When the products described herein are regulated products subject to the Wassenaar Arrangement or other agreements, they may not be exported without authorization from the appropriate governmental authority.
- Use of the information described herein for other purposes and/or reproduction or copying without the express permission of Seiko Instruments Inc. is strictly prohibited.
- The products described herein cannot be used as part of any device or equipment affecting the human body, such as exercise equipment, medical equipment, security systems, gas equipment, or any apparatus installed in airplanes and other vehicles, without prior written permission of Seiko Instruments Inc.
- Although Seiko Instruments Inc. exerts the greatest possible effort to ensure high quality and reliability, the failure or malfunction of semiconductor products may occur. The user of these products should therefore give thorough consideration to safety design, including redundancy, fire-prevention measures, and malfunction prevention, to prevent any accidents, fires, or community damage that may ensue.