



2 Channel Headset Microphone EMI Filter with ESD Protection

CSPEMI202AG

Features

- Two channels of EMI filtering
- Pi-style EMI filters in a capacitor-resistor-capacitor (C-R-C) network
- Greater than 40dB attenuation at 1GHz
- $\pm 8\text{kV}$ ESD protection on each channel (IEC 61000-4-2 Level 4, contact discharge)
- $\pm 15\text{kV}$ ESD protection on each channel (HBM)
- Supports bipolar signals—ideal for audio applications
- Chip Scale Package features extremely low lead inductance for optimum filter and ESD performance
- 5-bump, 0.930mm X 1.410mm footprint Chip Scale Package (CSP)
- RoHS compliant (lead-free) finishing

Applications

- EMI filtering and ESD protection for headset microphone ports
- Wireless Handsets
- Handheld PCs / PDAs
- MP3 Players
- Digital Camcorders
- Notebooks
- Desktop PCs

Product Description

The CSPEMI202AG is a dual low-pass filter array integrating two pi-style filters (C-R-C) that reduce EMI/RFI emissions while at the same time providing ESD protection. This part is custom-designed to interface with a microphone port on a cellular telephone or similar device. Each high quality filter provides more than 35dB attenuation in the 800-2700 MHz range. These pi-style filters support bidirectional filtering, controlling EMI both to and from a microphone element. They also support bipolar signals, enabling audio signals to pass through without distortion.

In addition, the CSPEMI202AG provides a very high level of protection for sensitive electronic components that may be subjected to electrostatic discharge (ESD). The diodes safely dissipate ESD strikes of $\pm 8\text{kV}$, the maximum requirement of the IEC 61000-4-2 international standard. Using the MIL-STD-883 (Method 3015) specification for Human Body Model (HBM) ESD, the device provides protection for contact discharges to greater than $\pm 15\text{kV}$.

The CSPEMI202AG is particularly well-suited for portable electronics (e.g., cellular telephones, PDAs, notebook computers) because of its small package format and low weight. The CSPEMI202AG is available in a space-saving, low-profile Chip Scale Package with RoHS compliant lead-free finishing.

Electrical Schematic

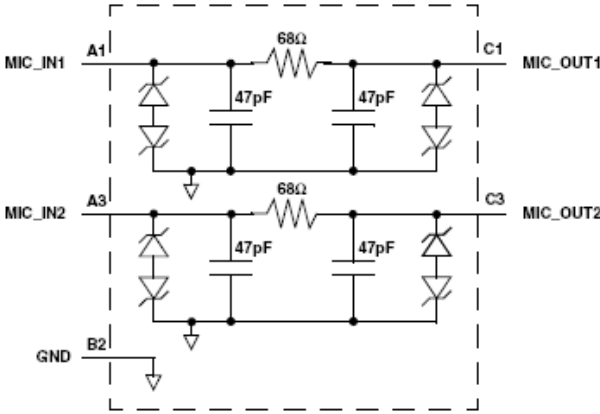

PACKAGE / PINOUT DIAGRAMS

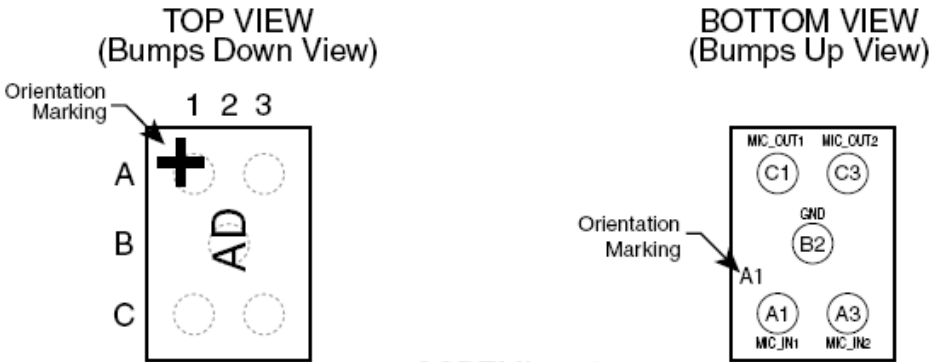

CSPEMI202A
CSP Package

Note:
1) These drawings are not to scale.

CSPEMI202AG

PIN DESCRIPTIONS

| PIN | NAME | DESCRIPTION |
|-----|----------|--|
| A1 | MIC_IN1 | Microphone Input 1 (from microphone) |
| A3 | MIC_IN2 | Microphone Input 2 (from microphone) |
| B2 | GND | Device Ground |
| C1 | MIC_OUT1 | Microphone Output 1 (to audio circuitry) |
| C3 | MIC_OUT2 | Microphone Output 2 (to audio circuitry) |

Ordering Information

PART NUMBERING INFORMATION

| Bumps | Package | Ordering Part Number ¹ | Part Marking |
|-------|---------|-----------------------------------|--------------|
| 5 | CSP | CSPEMI202AGG | AD |

Note 1: Parts are shipped in Tape & Reel form unless otherwise specified.

Specifications

| ABSOLUTE MAXIMUM RATINGS | | |
|---------------------------------|---------------|--------------|
| PARAMETER | RATING | UNITS |
| Storage Temperature Range | -65 to +150 | °C |
| DC Power per Resistor | 100 | mW |
| DC Package Power Rating | 200 | mW |

| STANDARD OPERATING CONDITIONS | | |
|--------------------------------------|---------------|--------------|
| PARAMETER | RATING | UNITS |
| Operating Temperature Range | -40 to +85 | °C |

ELECTRICAL OPERATING CHARACTERISTICS¹

| SYMBOL | PARAMETER | CONDITIONS | MIN | TYP | MAX | UNITS |
|------------|--|-----------------------------|---------------------|------------|----------|----------|
| R_1 | Resistance | | 61 | 68 | 75 | Ω |
| C_1 | Capacitance | | 38 | 47 | 56 | pF |
| I_{LEAK} | Diode Leakage Current | $V_{IN} = 5.0V$ | | | 1.0 | μA |
| V_{SIG} | Signal Voltage Positive Clamp Negative Clamp | $I_{LOAD} = 10mA$ | 5 -15 | 7 -10 | 15 -5 | V V |
| V_{ESD} | In-system ESD Withstand Voltage a) Human Body Model, MIL-STD-883, Method 3015 b) Contact Discharge per IEC 61000-4-2 Level 4 | Note 2 | ± 15 ± 8 | | | kV kV |
| V_{CL} | Clamping Voltage during ESD Discharge MIL-STD-883 (Method 3015), 8kV Positive Transients Negative Transients | Notes 2 and 3 | | +15 -19 | | V V |
| f_c | Cut-off frequency $Z_{SOURCE} = 50\Omega$, $Z_{LOAD} = 50\Omega$ | $R = 68\Omega$, $C = 47pF$ | | 60 | | MHz |

Note 1: $T_A = 25^\circ C$ unless otherwise specified.

Note 2: ESD applied to input and output pins with respect to GND, one at a time.

Note 3: Clamping voltage is measured at the opposite side of the EMI filter to the ESD pin. For example, if ESD is applied to Pin A1, then clamping voltage is measured at Pin C1.

Performance Information

Typical Filter Performance (nominal conditions unless specified otherwise, 50 Ohm Environment)

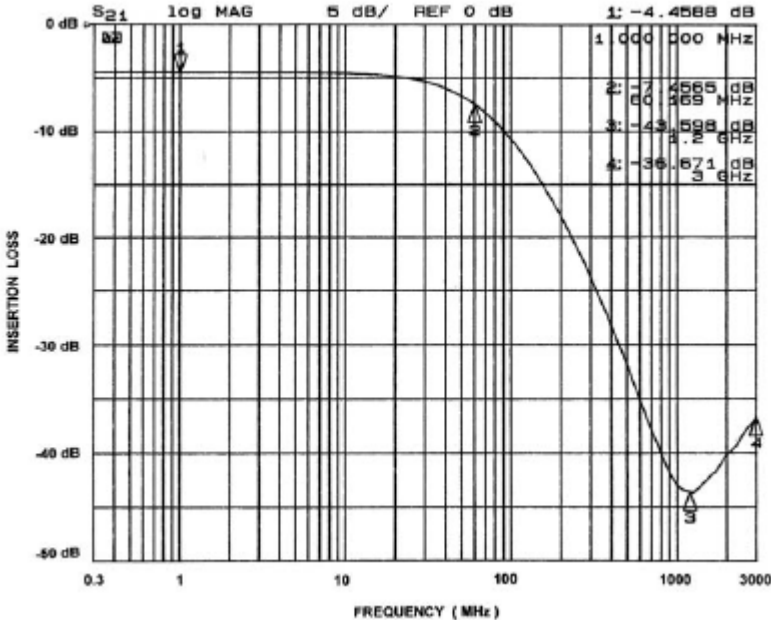

Figure 1. Insertion Loss VS. Frequency (A1-C1 to GND B2)

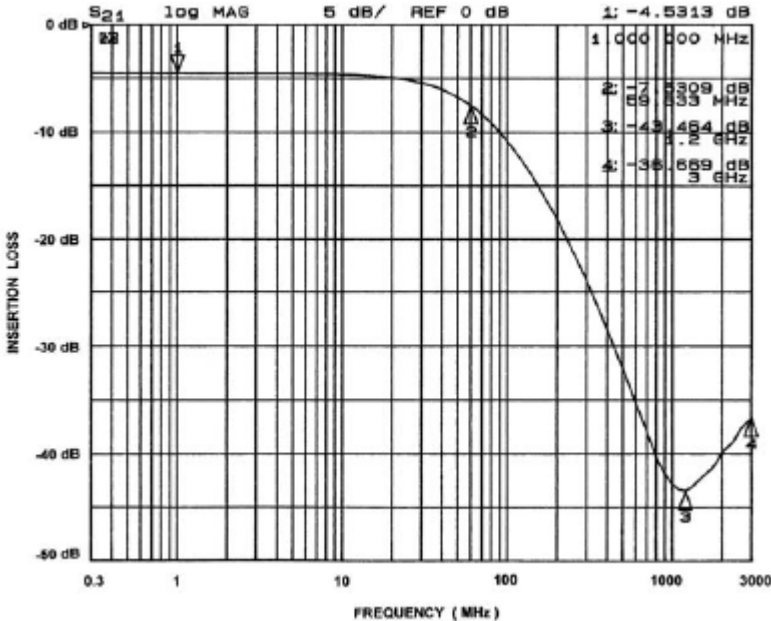

Figure 2. Insertion Loss VS. Frequency (A3-C3 to GND B2)

Application Information

Downloaded from Elcodis.com electronic components distributor

CSPEMI202AG

| PARAMETER | VALUE |
|--|------------------------------|
| Pad Size on PCB | 0.240mm |
| Pad Shape | Round |
| Pad Definition | Non-Solder Mask defined pads |
| Solder Mask Opening | 0.290mm Round |
| Solder Stencil Thickness | 0.125mm - 0.150mm |
| Solder Stencil Aperture Opening (laser cut, 5% tapered walls) | 0.300mm Round |
| Solder Flux Ratio | 50/50 by volume |
| Solder Paste Type | No Clean |
| Pad Protective Finish | OSP (Entek Cu Plus 106A) |
| Tolerance — Edge To Corner Ball | $\pm 50\mu\text{m}$ |
| Solder Ball Side Coplanarity | $\pm 20\mu\text{m}$ |
| Maximum Dwell Time Above Liquidous | 60 seconds |
| Maximum Soldering Temperature for Lead-free Devices using a Lead-free Solder Paste | 260°C |

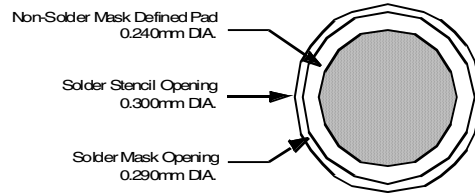

Figure 8. Recommended Non-Solder Mask Defined Pad Illustration

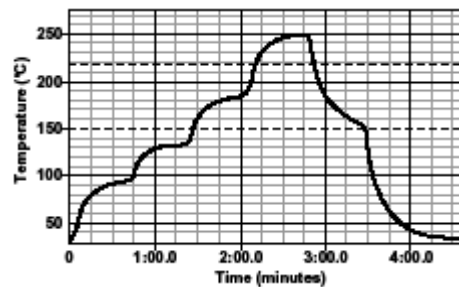

Figure 9. Lead-free (SnAgCu) Solder Ball Reflow Profile

Mechanical Details

CSP Mechanical Specifications

The CSPEMI202AG is available in a custom Chip Scale Package (CSP). Dimensions are presented below. For complete information on CMD's Chip Scale Packaging, see the California Micro Devices CSP Package Information document.

| PACKAGE DIMENSIONS | | | | | | |
|------------------------------------|-------------|-------|-------|--------|--------|--------|
| Package | Custom CSP | | | | | |
| Bumps | 5 | | | | | |
| Dim | Millimeters | | | Inches | | |
| | Min | Nom | Max | Min | Nom | Max |
| A1 | 0.885 | 0.930 | 0.975 | 0.0348 | 0.0366 | 0.0384 |
| A2 | 1.365 | 1.410 | 1.455 | 0.0537 | 0.0555 | 0.0573 |
| B1 | 0.495 | 0.500 | 0.505 | 0.0195 | 0.0197 | 0.0199 |
| B2 | 0.245 | 0.250 | 0.255 | 0.0096 | 0.0098 | 0.0100 |
| B3 | 0.430 | 0.435 | 0.440 | 0.0169 | 0.0171 | 0.0173 |
| B4 | 0.430 | 0.435 | 0.440 | 0.0169 | 0.0171 | 0.0173 |
| C1 | 0.165 | 0.215 | 0.265 | 0.0065 | 0.0085 | 0.0104 |
| C2 | 0.220 | 0.270 | 0.320 | 0.0087 | 0.0106 | 0.0126 |
| D1 | 0.562 | 0.606 | 0.650 | 0.0221 | 0.0239 | 0.0256 |
| D2 | 0.356 | 0.381 | 0.406 | 0.0140 | 0.0150 | 0.0160 |
| # per tape and reel | 3500 pieces | | | | | |
| Controlling dimension: millimeters | | | | | | |

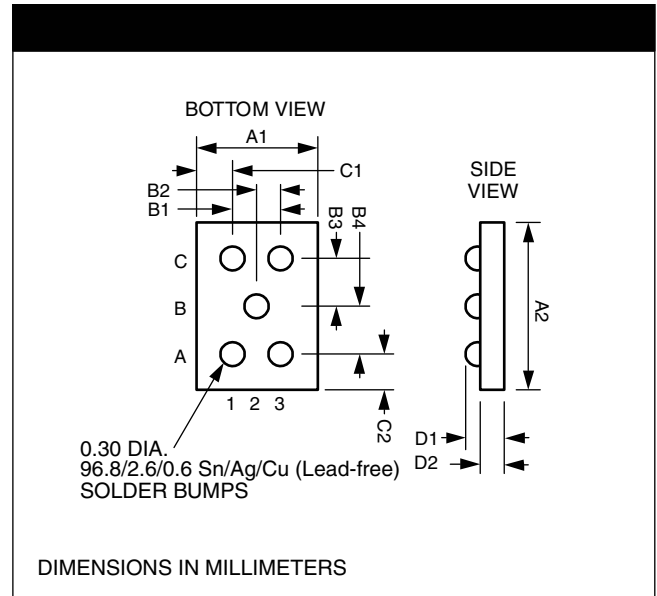

**Package Dimensions for
CSPEMI202AG Chip Scale Package**

CSPEMI202AG

CSP Tape and Reel Specifications

| PART NUMBER | CHIP SIZE (mm) | POCKET SIZE (mm) $B_0 \times A_0 \times K_0$ | TAPE WIDTH W | REEL DIAMETER | QTY PER REEL | P_0 | P_1 |
|-------------|---------------------|---|-----------------|------------------|-----------------|-------|-------|
| CSPEMI202AG | 1.41 X 0.93 X 0.606 | 1.52 X 1.07 X 0.72 | 8mm | 178mm (7") | 3500 | 4mm | 4mm |

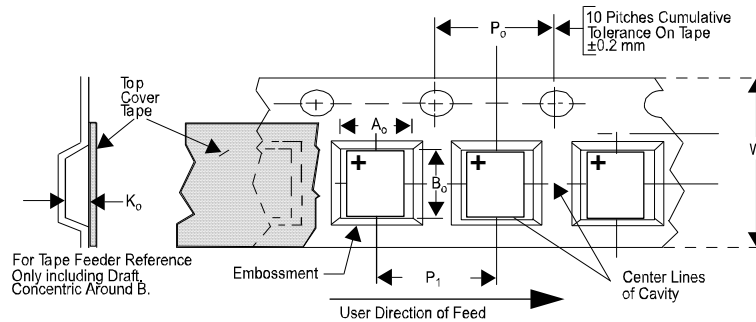

Figure 5. Tape and Reel Mechanical Data

ON Semiconductor and are registered trademarks of Semiconductor Components Industries, LLC (SCILLC). SCILLC reserves the right to make changes without further notice to any products herein. SCILLC makes no warranty, representation or guarantee regarding the suitability of its products for any particular purpose, nor does SCILLC assume any liability arising out of the application or use of any product or circuit, and specifically disclaims any and all liability, including without limitation special, consequential or incidental damages. "Typical" parameters which may be provided in SCILLC data sheets and/or specifications can and do vary in different applications and actual performance may vary over time. All operating parameters, including "Typicals" must be validated for each customer application by customer's technical experts. SCILLC does not convey any license under its patent rights nor the rights of others. SCILLC products are not designed, intended, or authorized for use as components in systems intended for surgical implant into the body, or other applications intended to support or sustain life, or for any other application in which the failure of the SCILLC product could create a situation where personal injury or death may occur. Should Buyer purchase or use SCILLC products for any such unintended or unauthorized application, Buyer shall indemnify and hold SCILLC and its officers, employees, subsidiaries, affiliates, and distributors harmless against all claims, costs, damages, and expenses, and reasonable attorney fees arising out of, directly or indirectly, any claim of personal injury or death associated with such unintended or unauthorized use, even if such claim alleges that SCILLC was negligent regarding the design or manufacture of the part. SCILLC is an Equal Opportunity/Affirmative Action Employer. This literature is subject to all applicable copyright laws and is not for resale in any manner.

PUBLICATION ORDERING INFORMATION

LITERATURE FULFILLMENT:

Literature Distribution Center for ON Semiconductor
P.O. Box 5163, Denver, Colorado 80217 USA
Phone: 303-675-2175 or 800-344-3860 Toll Free USA/Canada
Fax: 303-675-2176 or 800-344-3867 Toll Free USA/Canada
Email: orderlit@onsemi.com

N. American Technical Support: 800-282-9855
Toll Free USA/Canada
Europe, Middle East and Africa Technical Support:
Phone: 421 33 790 2910
Japan Customer Focus Center
Phone: 81-3-5773-3850

ON Semiconductor Website: www.onsemi.com

Order Literature: <http://www.onsemi.com/orderlit>

For additional information, please contact your local Sales Representative