

QG030-148/12

# DC tangential blower

forward curved



**ebm-papst St. Georgen GmbH & Co. KG**

Hermann-Papst-Straße 1

78112 St. Georgen

Phone: +49 7724 81-0

Fax: +49 7724 81-1309

www.ebmpapst.com

info2@de.ebmpapst.com

## Nominal data

Type	QG030-148/12	
Nominal voltage	[VDC]	12
Nominal voltage range	[VDC]	8 .. 14
Power input	[W]	6.2
Min. ambient temperature	[°C]	-20
Max. ambient temperature	[°C]	60
Air flow	[m <sup>3</sup> /h]	75
Sound pressure level	[dB(A)]	49

ml = max. load · me = max. efficiency · rfa = running at free air · cs = customer specs · cu = customer unit  
Subject to alterations

## Technical features

<b>General description</b>	Cross flow fan with high air flow. Large outflow surface. Electronic commutation completely integrated.
<b>Locked-rotor protection</b>	Blocking and overload protection
<b>Direction of protection</b>	Right, looking at rotor
<b>Note</b>	Tangential fans are suitable for operation at high air flow and low counterpressure only.
<b>Bearing</b>	Motor with ball bearing system. Impeller bracket with sliding bearings.
<b>Lifetime L10 at 40 °C</b>	30000 h
<b>Lifetime L10 at maximum temperature</b>	10000 h
<b>Mass</b>	0.235 kg
<b>Housing material</b>	Aluminum, housing side parts of plastic.
<b>Material of impeller</b>	Aluminum
<b>Motor protection</b>	Protected against reverse polarity and locking.
<b>Approval</b>	VDE, CSA, UL, CE

Product drawing

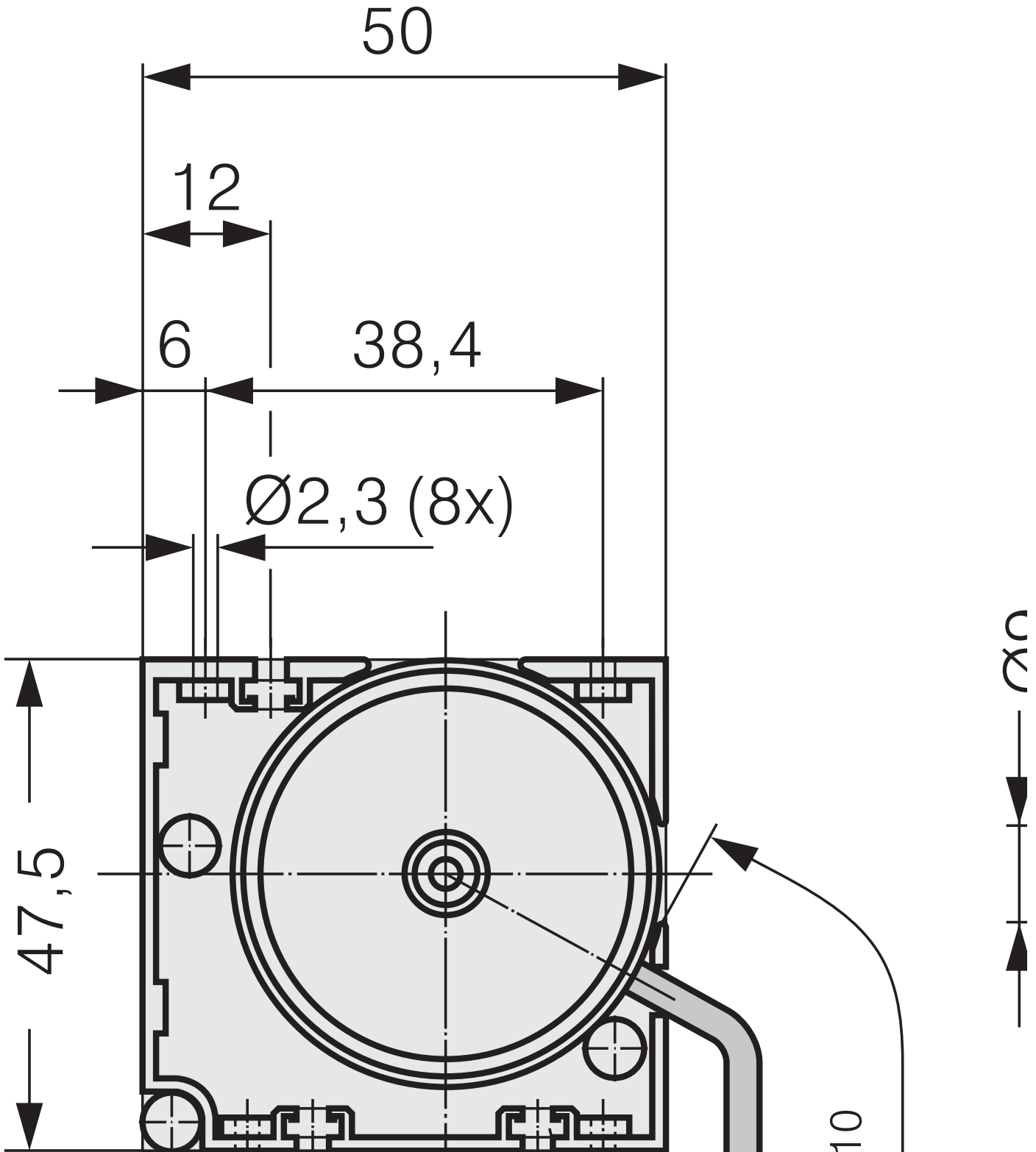

## Charts: Air flow

