



Muffin XL - MD48B3 - 032038 - No
 (Family) (Model) (Part #) (In Stock)

Electrical Specifications

Operating Voltage:	48 Volts
Voltage Range:	24 - 56 Volts
Power Supply:	5.8 Watts
Line Current:	0.12 Amps
Locked Rotor Current	0.40 Amps
Nominal Speed:	3100 RPM

Mechanical Specifications

Dimensions:	4.7 x 4.7 x 1.5 in
Weight	21.52 oz
Max Airflow @ 0 in H ₂ O	110.0 CFM
Max Pressure @ 0 CFM	0.278 in H ₂ O
Noise	50.0 dBA



Mechanical Drawing

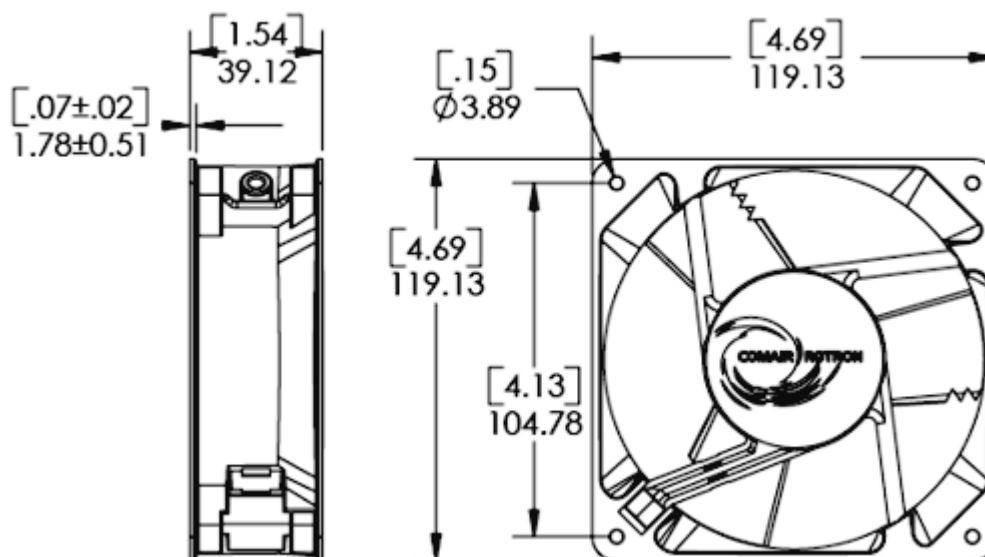

Comair Rotron, Inc.
 Phone: 619.651.2000
 sales@comairrotron.com

Comair Rotron Europe, Ltd.
 Phone: +44.1527.520525
 saleseurope@comairrotron.com

Comair Rotron Fan Company Ltd.
 Phone: +86.21.52260581
 salesasia@comairrotron.com

Print Date: Wednesday, November 10, 2010 at 10:05:53 - DC Fan Datasheet - Web Version 1.0 Rev. B



Fan Performance Curve

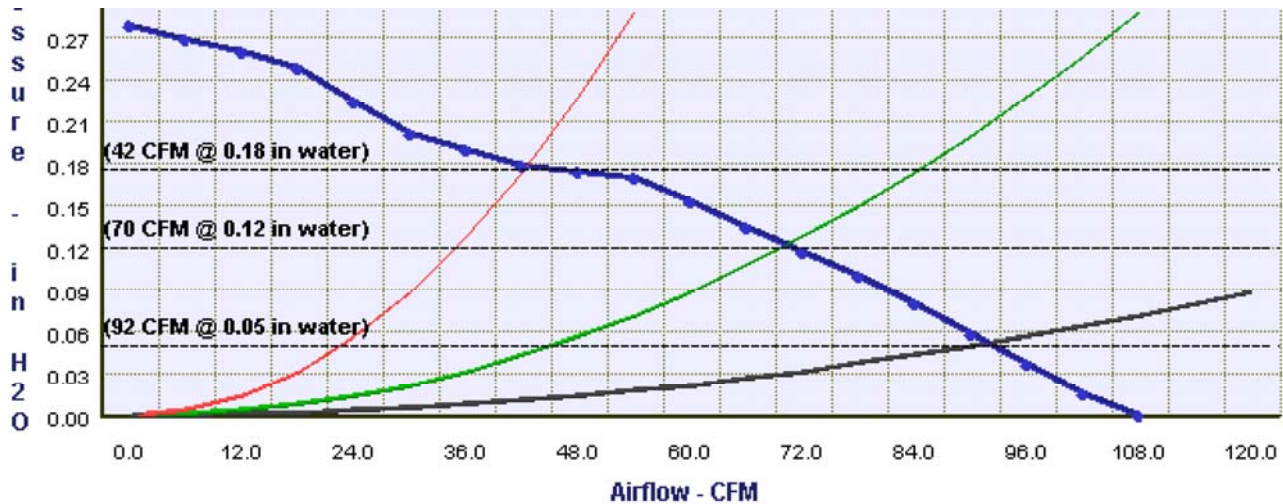

Fan Configuration Options

Muffin XL (Family)
 MD48B3 / 032038 (Model)
 No (In Stock)
 305 mm [12 inch] Leads (Features)

Fan Speed: 3100 RPM
Fan Bearings: Ball Bearings
Fan Airflow Direction: Flow R (CCW Rotation)
Fan Termination: Leads

Fan Monitoring Options: No Fan Monitoring Options Selected

Fan Speed Control Option: No ThermaPro-V Fan Speed Control Options Selected

Environmental Protection Options: No Enviroshield Options Selected

Comair Rotron, Inc.
 Phone: 619.651.2000
 sales@comairrotron.com

Comair Rotron Europe, Ltd.
 Phone: +44.1527.520525
 saleseurope@comairrotron.com

Comair Rotron Fan Company Ltd.
 Phone: +86.21.52260581
 salesasia@comairrotron.com

Print Date: Wednesday, November 10, 2010 at 10:05:53 - DC Fan Datasheet - Web Version 1.0 Rev. B



Accessories (Click on part number for detailed drawing.)

- 571064
Plug and Cord



- 550113
Mounting Clip

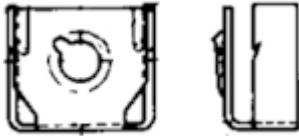

- 551590
Filter Assembly
-
- Mounting Bracket Filter Frame
Filter Element
Fan Venturi Edge

- 554148
Filter Guard Assembly

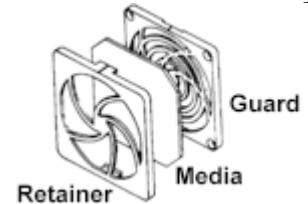

- 552934
Finger Guard



- 476042
Finger Guard

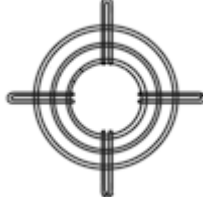

- 550481
Finger Guard

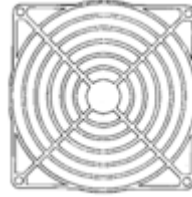

- 551147
Finger Guard

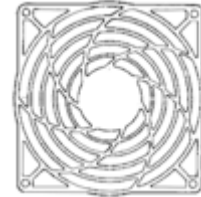

Comair Rotron, Inc.
Phone: 619.651.2000
sales@comairrotron.com

Comair Rotron Europe, Ltd.
Phone: +44.1527.520525
saleseurope@comairrotron.com

Comair Rotron Fan Company Ltd.
Phone: +86.21.52260581
salesasia@comairrotron.com

Print Date: Wednesday, November 10, 2010 at 10:05:53 - DC Fan Datasheet - Web Version 1.0 Rev. B