

**ebm-papst St. Georgen GmbH & Co. KG**

Hermann-Papst-Straße 1

78112 St. Georgen

Phone: +49 7724 81-0

Fax: +49 7724 81-1309

www.ebmpapst.com

info2@de.ebmpapst.com

Nominal data

Type	412 J	
Nominal voltage	[VDC]	12
Nominal voltage range	[VDC]	8 .. 14
Speed	[min ⁻¹]	10300
Power input	[W]	2.4
Min. ambient temperature	[°C]	-20
Max. ambient temperature	[°C]	70
Air flow	[m ³ /h]	19
Sound power level	[B]	5.3
Sound pressure level	[dB(A)]	39

ml = max. load · me = max. efficiency · rfa = running at free air · cs = customer specs · cu = customer unit
Subject to alterations

Technical features

Dimensions	40 x 40 x 25 mm
General description	Low operating noise level at high counterpressure. Rigid compression curve for high air flow at high counterpressure. Electronic commutation completely integrated.
Connection line	Single strands AWG 26, TR 64, bared and tin-plated.
Direction of protection	Left, looking at rotor
Direction of air flow	Air exhaust over bars
Bearing	Ball bearings
Lifetime L10 at 20 °C	60000 h
Lifetime L10 at maximum temperature	30000 h
Mass	0.050 kg
Housing material	Fiberglass-reinforced PBT plastic
Material of impeller	Fiberglass-reinforced PA plastic
Motor protection	Protected against reverse polarity and locking.
Approval	VDE, CSA, UL

Product drawing

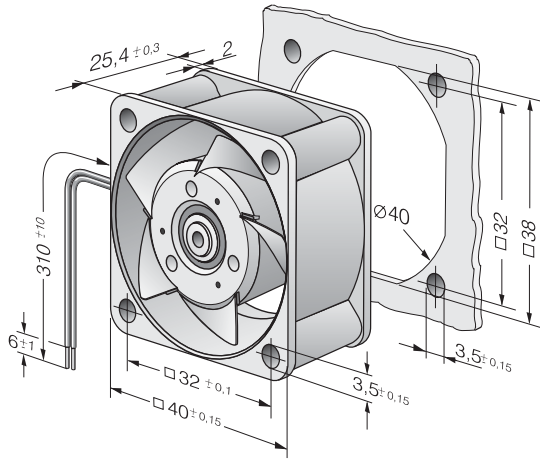

Charts: Air flow

