



**Muffin XL AC - MX2B1 - 028420**  
 (Family) (Model) (Part Number)

### Electrical Specifications

Rated Voltage:	115 VAC
AC Frequency:	60 Hz
Power Supply:	15.0 Watts
Line Current:	0.18 Amps
Locked Rotor Current	0.27 Amps
Nominal Speed:	3100 RPM

### Mechanical Specifications

Dimensions:	4.72in x 1.50in
Weight	21.0 oz
Max Airflow @ 0 in H <sub>2</sub> O	105.0 CFM
Max Pressure @ 0 CFM	0.223 in H <sub>2</sub> O
Noise	47.6 dBA



Comair Rotron, Inc.  
 Phone: 619.651.2000  
 sales@comairrotron.com

Comair Rotron Europe, Ltd.  
 Phone: +44.1527.520525  
 saleseurope@comairrotron.com

Comair Rotron Fan Company Ltd.  
 Phone: +86.21.52260581  
 salesasia@comairrotron.com

Print Date: Wednesday, November 10, 2010 at 10:14:36 - AC Fan Datasheet - Web Version 1.0 Rev. A



## Mechanical Drawing

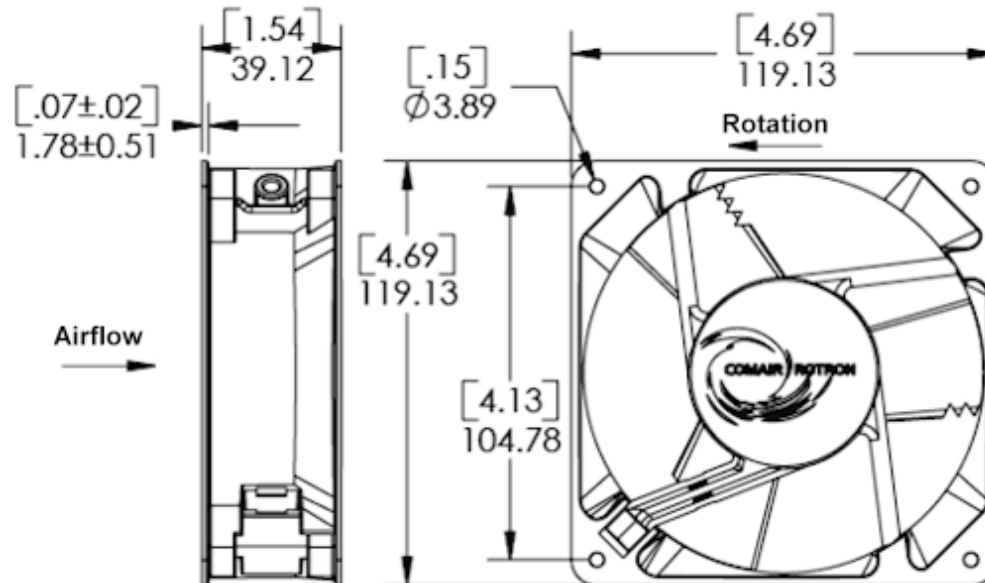

## Options

Part Number	Model Number	Bearing Type	Fan Rotation	Termination	In-Stock (Click 'Yes' for current stock)
<input checked="" type="radio"/> 028420	MX2B1	Ball	Normal	0.120 Terminals	No
<input type="radio"/> 030519	MX2B2	Ball	Normal	Leads	No
<input type="radio"/> 028422	MX2B3	Ball	Reverse	0.120 Terminals	No
<input type="radio"/> 030389	MX2B4	Ball	Reverse	Leads	No
<input type="radio"/> 028534	MX2B7	Ball	Reverse	0.187 Terminals	No
<input type="radio"/> 028318	MX2A1	Sleeve	Normal	0.120 Terminals	No
<input type="radio"/> 030503	MX2A2	Sleeve	Normal	Leads	No
<input type="radio"/> 028316	MX2A3	Sleeve	Reverse	0.120 Terminals	No
<input type="radio"/> 028476	MX2A4	Sleeve	Reverse	Leads	No
<input type="radio"/> 028541	MX2A7	Sleeve	Reverse	0.187 Terminals	No

## Accessories [\(Click on part number for detailed drawing.\)](#)

428056  
Plug and Cord

550440  
Plug and Cord

550113  
Mounting Clip

551590  
Filter Assembly

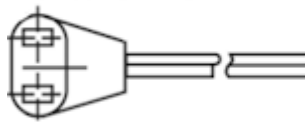

554148  
Filter Guard Assembly

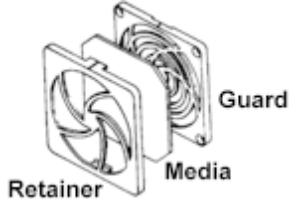

551147  
Finger Guard

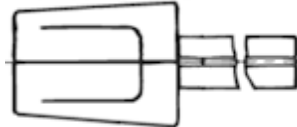

552934  
Finger Guard

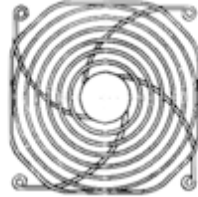

476042  
Finger Guard

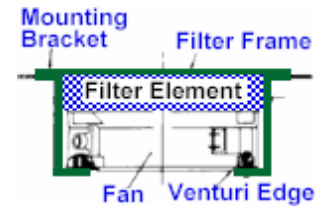

550481  
Finger Guard

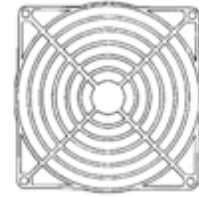

**Comair Rotron, Inc.**  
Phone: 619.651.2000  
sales@comairrotron.com

**Comair Rotron Europe, Ltd.**  
Phone: +44.1527.520525  
saleseurope@comairrotron.com

**Comair Rotron Fan Company Ltd.**  
Phone: +86.21.52260581  
salesasia@comairrotron.com

Print Date: Wednesday, November 10, 2010 at 10:14:36 - AC Fan Datasheet - Web Version 1.0 Rev. A