



**Muffin XL AC - MX2B2 - 030519**  
 (Family) (Model) (Part Number)

### Electrical Specifications

Rated Voltage:	115 VAC
AC Frequency:	60 Hz
Power Supply:	15.0 Watts
Line Current:	0.18 Amps
Locked Rotor Current	0.27 Amps
Nominal Speed:	3100 RPM

### Mechanical Specifications

Dimensions:	4.72in x 1.50in
Weight	21.0 oz
Max Airflow @ 0 in H <sub>2</sub> O	105.0 CFM
Max Pressure @ 0 CFM	0.223 in H <sub>2</sub> O
Noise	47.6 dBA



Fan Performance

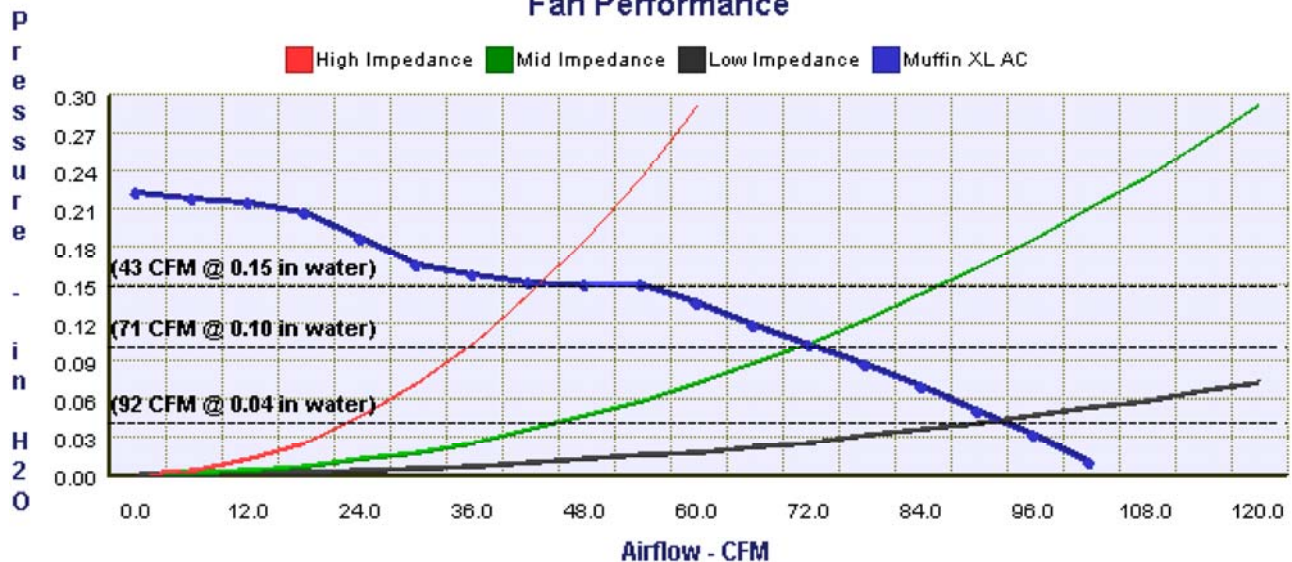

Comair Rotron, Inc.  
 Phone: 619.651.2000  
[sales@comairrotron.com](mailto:sales@comairrotron.com)

Comair Rotron Europe, Ltd.  
 Phone: +44.1527.520525  
[saleseurope@comairrotron.com](mailto:saleseurope@comairrotron.com)

Comair Rotron Fan Company Ltd.  
 Phone: +86.21.52260581  
[salesasia@comairrotron.com](mailto:salesasia@comairrotron.com)

Print Date: Wednesday, November 10, 2010 at 09:58:47 - AC Fan Datasheet - Web Version 1.0 Rev. A



## Mechanical Drawing

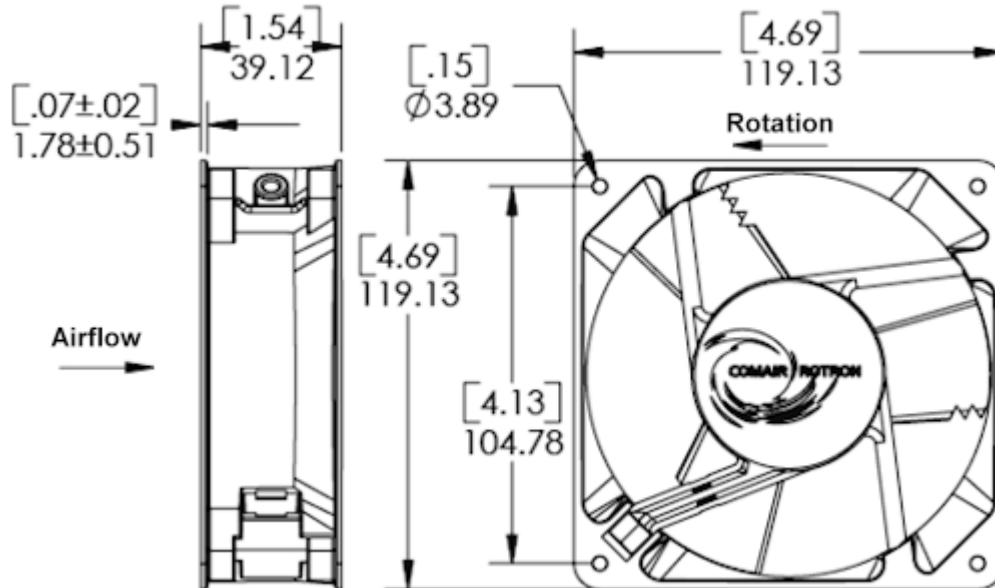

## Options

Part Number	Model Number	Bearing Type	Fan Rotation	Termination	In-Stock <small>(Click 'Yes' for current stock)</small>
<input type="radio"/> 028420	MX2B1	Ball	Normal	0.120 Terminals	No
<input checked="" type="radio"/> 030519	MX2B2	Ball	Normal	Leads	No
<input type="radio"/> 028422	MX2B3	Ball	Reverse	0.120 Terminals	No
<input type="radio"/> 030389	MX2B4	Ball	Reverse	Leads	No
<input type="radio"/> 028534	MX2B7	Ball	Reverse	0.187 Terminals	No
<input type="radio"/> 028318	MX2A1	Sleeve	Normal	0.120 Terminals	No
<input type="radio"/> 030503	MX2A2	Sleeve	Normal	Leads	No
<input type="radio"/> 028316	MX2A3	Sleeve	Reverse	0.120 Terminals	No
<input type="radio"/> 028476	MX2A4	Sleeve	Reverse	Leads	No
<input type="radio"/> 028541	MX2A7	Sleeve	Reverse	0.187 Terminals	No

## Accessories (Click on part number for detailed drawing.)

428056  
Plug and Cord

550440  
Plug and Cord

550113  
Mounting Clip

551590  
Filter Assembly

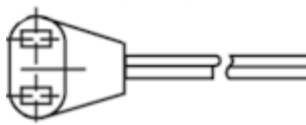

554148  
Filter Guard Assembly

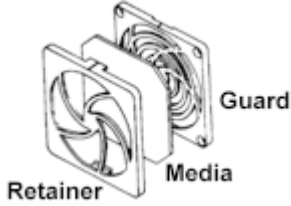

551147  
Finger Guard

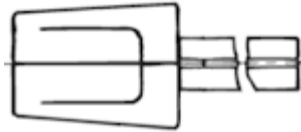

552934  
Finger Guard

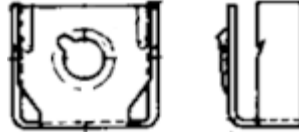

476042  
Finger Guard

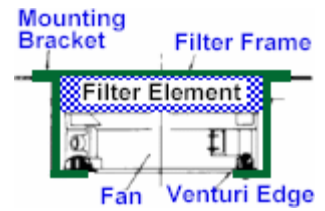
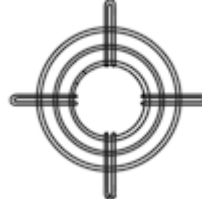

550481  
Finger Guard

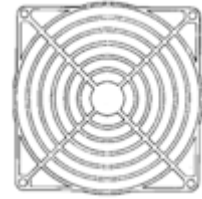

**Comair Rotron, Inc.**  
Phone: 619.651.2000  
sales@comairrotron.com

**Comair Rotron Europe, Ltd.**  
Phone: +44.1527.520525  
saleseurope@comairrotron.com

**Comair Rotron Fan Company Ltd.**  
Phone: +86.21.52260581  
salesasia@comairrotron.com

Print Date: Wednesday, November 10, 2010 at 09:58:47 - AC Fan Datasheet - Web Version 1.0 Rev. A