



Muffin XL AC - MX77A2 - 028989
 (Family) (Model) (Part Number)

Electrical Specifications

Rated Voltage: 230 VAC
 AC Frequency: 60 Hz
 Power Supply: 15.0 Watts
 Line Current: 0.08 Amps
 Locked Rotor Current: 0.12 Amps
 Nominal Speed: 2940 RPM



Mechanical Specifications

Dimensions: 4.72in x 1.50in
 Weight: 21.0 oz
 Max Airflow @ 0 in H₂O: 105.0 CFM
 Max Pressure @ 0 CFM: 0.223 in H₂O
 Noise: 47.6 dBA



Fan Performance

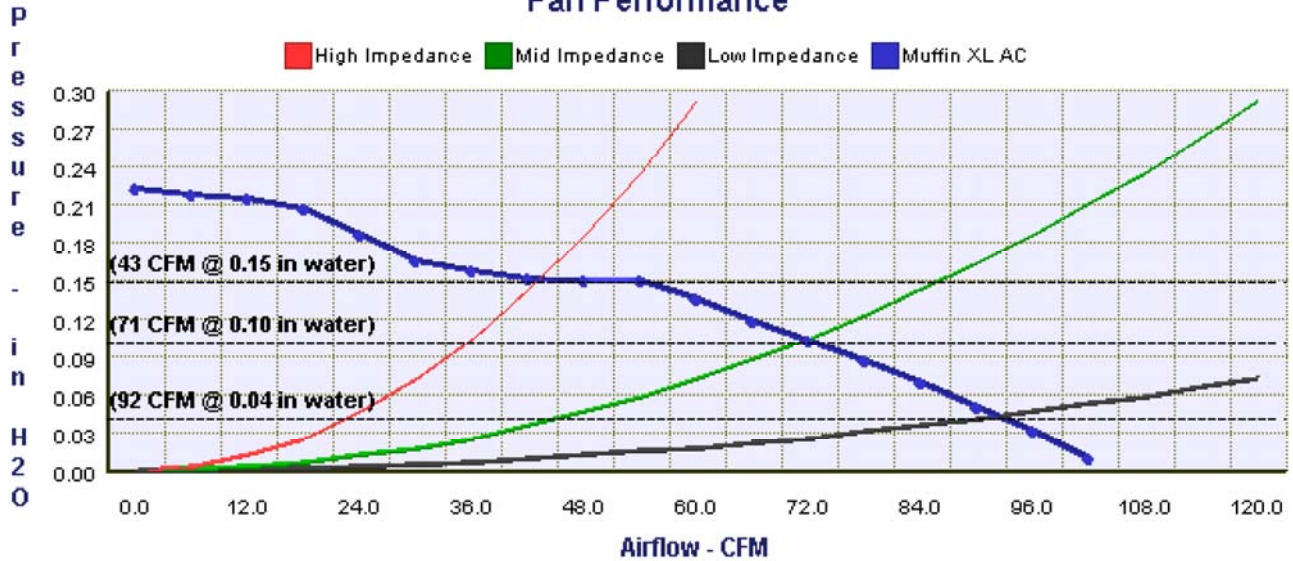

Comair Rotron, Inc.
 Phone: 619.651.2000
 sales@comairrotron.com

Comair Rotron Europe, Ltd.
 Phone: +44.1527.520525
 saleseurope@comairrotron.com

Comair Rotron Fan Company Ltd.
 Phone: +86.21.52260581
 salesasia@comairrotron.com

Print Date: Wednesday, November 10, 2010 at 09:56:07 - AC Fan Datasheet - Web Version 1.0 Rev. A



Mechanical Drawing

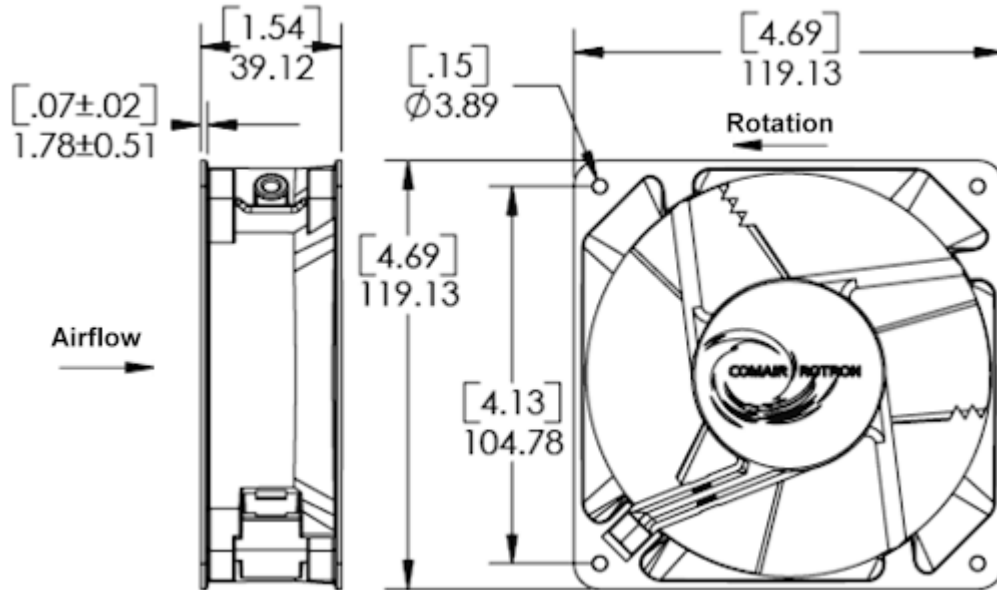

Options

Part Number	Model Number	Bearing Type	Fan Rotation	Termination	In-Stock <small>(Click 'Yes' for current stock)</small>
<input type="radio"/> 028793	MX77B3	Ball	Reverse	0.120 Terminals	No
<input type="radio"/> 028781	MX77A1	Sleeve	Normal	0.120 Terminals	No
<input checked="" type="radio"/> 028989	MX77A2	Sleeve	Normal	Leads	No
<input type="radio"/> 028792	MX77A3	Sleeve	Reverse	0.120 Terminals	No

Accessories [\(Click on part number for detailed drawing.\)](#)

428056
Plug and Cord

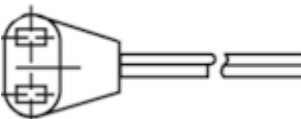

550440
Plug and Cord

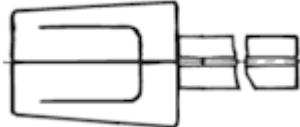

550113
Mounting Clip



551590
Filter Assembly
Mounting Bracket
Filter Frame
Filter Element
Fan
Venturi Edge

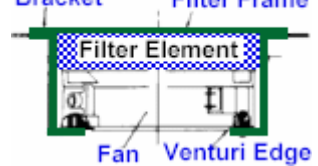

554148
Filter Guard Assembly

552934
Finger Guard

476042
Finger Guard

550481
Finger Guard

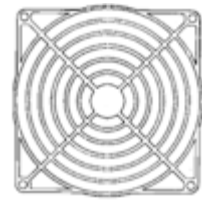
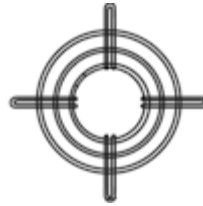
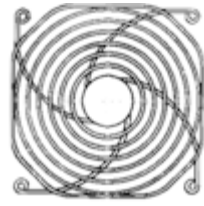
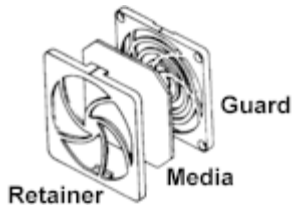

551147
Finger Guard



Comair Rotron, Inc.
Phone: 619.651.2000
sales@comairrotron.com

Comair Rotron Europe, Ltd.
Phone: +44.1527.520525
saleseurope@comairrotron.com

Comair Rotron Fan Company Ltd.
Phone: +86.21.52260581
salesasia@comairrotron.com

Print Date: Wednesday, November 10, 2010 at 09:56:07 - AC Fan Datasheet - Web Version 1.0 Rev. A