



**Muffin XL AC - MX3A1 - 028326**  
 (Family) (Model) (Part Number)

### Electrical Specifications

Rated Voltage:	230 VAC
AC Frequency:	60 Hz
Power Supply:	16.0 Watts
Line Current:	0.09 Amps
Locked Rotor Current	0.14 Amps
Nominal Speed:	3100 RPM

### Mechanical Specifications

Dimensions:	4.72in x 1.50in
Weight	21.0 oz
Max Airflow @ 0 in H <sub>2</sub> O	105.0 CFM
Max Pressure @ 0 CFM	0.223 in H <sub>2</sub> O
Noise	47.6 dBA



Fan Performance

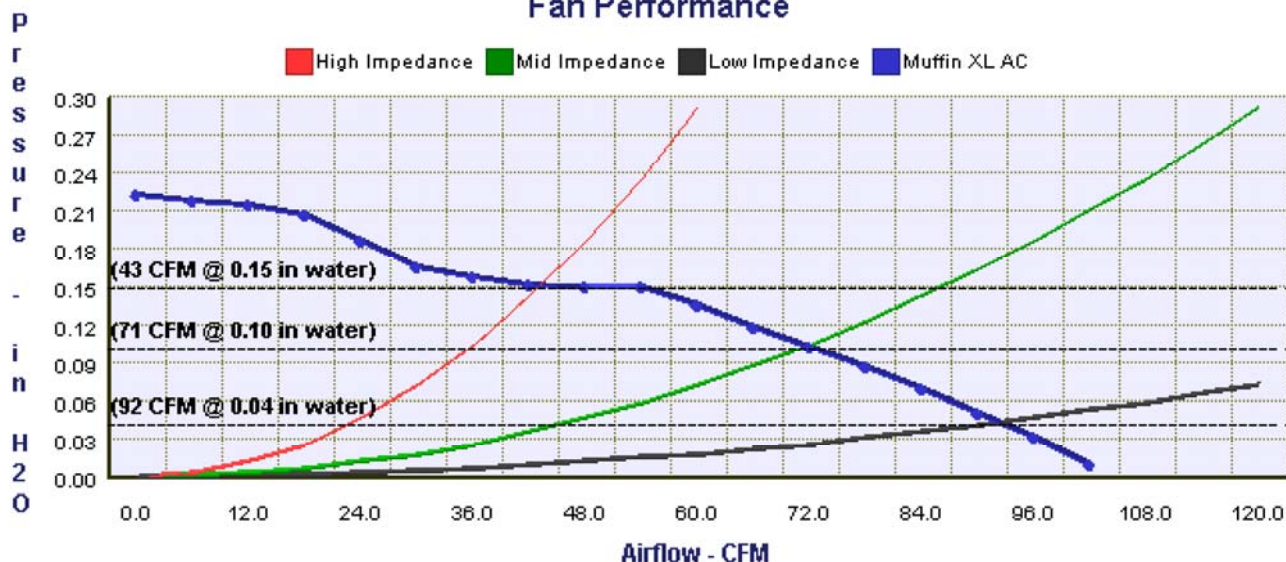

Comair Rotron, Inc.  
 Phone: 619.651.2000  
[sales@comairrotron.com](mailto:sales@comairrotron.com)

Comair Rotron Europe, Ltd.  
 Phone: +44.1527.520525  
[saleseurope@comairrotron.com](mailto:saleseurope@comairrotron.com)

Comair Rotron Fan Company Ltd.  
 Phone: +86.21.52260581  
[salesasia@comairrotron.com](mailto:salesasia@comairrotron.com)

Print Date: Wednesday, November 10, 2010 at 09:50:45 - AC Fan Datasheet - Web Version 1.0 Rev. A



### Mechanical Drawing

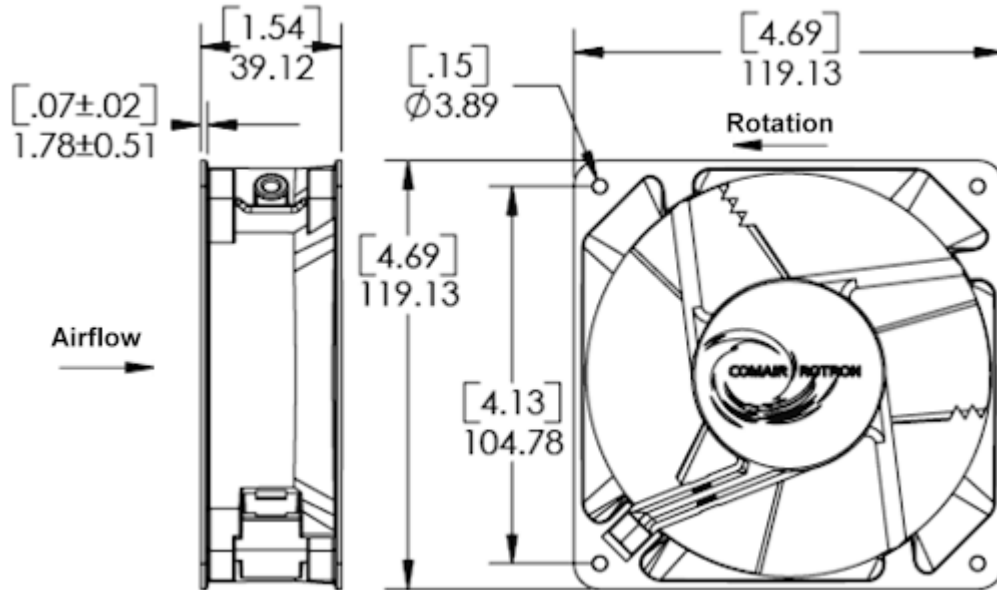

### Options

Part Number	Model Number	Bearing Type	Fan Rotation	Termination	In-Stock <small>(Click 'Yes' for current stock)</small>
<input type="radio"/> 028421	MX3B1	Ball	Normal	0.120 Terminals	No
<input type="radio"/> 031000	MX3B2	Ball	Normal	Leads	No
<input type="radio"/> 028423	MX3B3	Ball	Reverse	0.120 Terminals	No
<input type="radio"/> 030913	MX3B4	Ball	Reverse	Leads	No
<input checked="" type="radio"/> 028326	MX3A1	Sleeve	Normal	0.120 Terminals	No
<input type="radio"/> 028324	MX3A3	Sleeve	Reverse	0.120 Terminals	No
<input type="radio"/> 031003	MX3A4	Sleeve	Reverse	Leads	No

### Accessories (Click on part number for detailed drawing.)

428056  
Plug and Cord

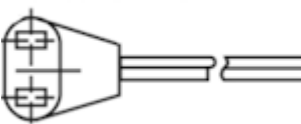

550440  
Plug and Cord

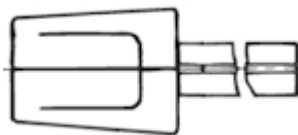

550113  
Mounting Clip



551590  
Filter Assembly

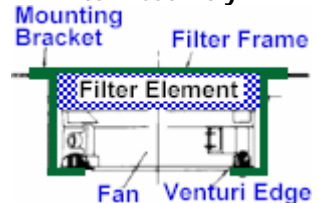

554148

552934

476042

550481

**Filter Guard Assembly**

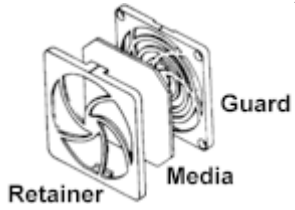

**551147**  
**Finger Guard**



**Finger Guard**

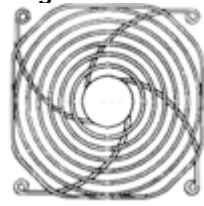

**Finger Guard**

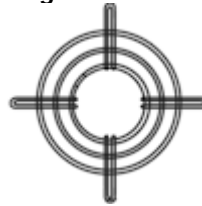

**Finger Guard**

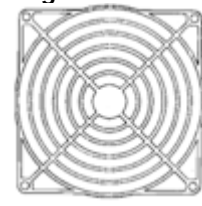

**Comair Rotron, Inc.**  
Phone: 619.651.2000  
sales@comairrotron.com

**Comair Rotron Europe, Ltd.**  
Phone: +44.1527.520525  
saleseurope@comairrotron.com

**Comair Rotron Fan Company Ltd.**  
Phone: +86.21.52260581  
salesasia@comairrotron.com

Print Date: Wednesday, November 10, 2010 at 09:50:45 - AC Fan Datasheet - Web Version 1.0 Rev. A