

# NSS40302PDR2G

## Complementary 40 V, 6.0 A, Low $V_{CE(sat)}$ Transistor

ON Semiconductor's e<sup>2</sup>PowerEdge family of low  $V_{CE(sat)}$  transistors are surface mount devices featuring ultra low saturation voltage ( $V_{CE(sat)}$ ) and high current gain capability. These are designed for use in low voltage, high speed switching applications where affordable efficient energy control is important.

Typical applications are low voltage motor controls in mass storage products such as disc drives and tape drives. In the automotive industry they can be used in air bag deployment and in the instrument cluster. The high current gain allows e<sup>2</sup>PowerEdge devices to be driven directly from PMU's control outputs, and the Linear Gain (Beta) makes them ideal components in analog amplifiers.

### Features

- Halide Free
- This is a Pb-Free Device

### MAXIMUM RATINGS ( $T_A = 25^\circ\text{C}$ )

Rating		Symbol	Max	Unit
Collector-Emitter Voltage	NPN PNP	$V_{CEO}$	40 -40	Vdc
Collector-Base Voltage	NPN PNP	$V_{CBO}$	40 -40	Vdc
Emitter-Base Voltage	NPN PNP	$V_{EBO}$	6.0 -7.0	Vdc
Collector Current - Continuous	NPN PNP	$I_C$	3.0 -3.0	A
Collector Current - Peak	NPN PNP	$I_{CM}$	6.0 -6.0	A
Electrostatic Discharge		ESD	HBM Class 3B MM Class C	

Stresses exceeding Maximum Ratings may damage the device. Maximum Ratings are stress ratings only. Functional operation above the Recommended Operating Conditions is not implied. Extended exposure to stresses above the Recommended Operating Conditions may affect device reliability.



**ON Semiconductor**<sup>®</sup>

<http://onsemi.com>

**40 VOLTS, 6.0 AMPS  
COMPLEMENTARY LOW  
 $V_{CE(sat)}$  TRANSISTOR  
EQUIVALENT  $R_{DS(on)}$  80 m $\Omega$**

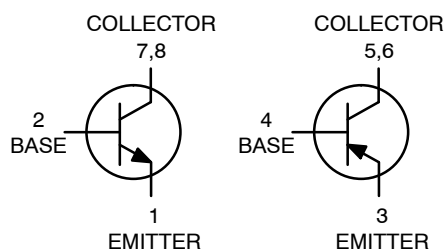

**SOIC-8  
CASE 751  
STYLE 16**

### DEVICE MARKING

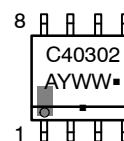

C40302 = Specific Device Code  
 A = Assembly Location  
 Y = Year  
 WW = Work Week  
 ■ = Pb-Free Package  
 (Note: Microdot may be in either location)

### ORDERING INFORMATION

Device	Package	Shipping <sup>†</sup>
NSS40302PDR2G	SOIC-8 (Pb-Free)	2500 / Tape & Reel

<sup>†</sup>For information on tape and reel specifications, including part orientation and tape sizes, please refer to our Tape and Reel Packaging Specification Brochure, BRD8011/D.

# NSS40302PDR2G

## THEMAL CHARACTERISTICS

Characteristic	Symbol	Max	Unit
----------------	--------	-----	------

### SINGLE HEATED

Total Device Dissipation (Note 1) $T_A = 25^\circ\text{C}$ Derate above $25^\circ\text{C}$	$P_D$	576	mW
		4.6	mW/ $^\circ\text{C}$
Thermal Resistance, Junction-to-Ambient (Note 1)	$R_{\theta JA}$	217	$^\circ\text{C}/\text{W}$
Total Device Dissipation (Note 2) $T_A = 25^\circ\text{C}$ Derate above $25^\circ\text{C}$	$P_D$	676	mW
		5.4	mW/ $^\circ\text{C}$
Thermal Resistance, Junction-to-Ambient (Note 2)	$R_{\theta JA}$	185	$^\circ\text{C}/\text{W}$

### DUAL HEATED (Note 3)

Total Device Dissipation (Note 1) $T_A = 25^\circ\text{C}$ Derate above $25^\circ\text{C}$	$P_D$	653	mW
		5.2	mW/ $^\circ\text{C}$
Thermal Resistance, Junction-to-Ambient (Note 1)	$R_{\theta JA}$	191	$^\circ\text{C}/\text{W}$
Total Device Dissipation (Note 2) $T_A = 25^\circ\text{C}$ Derate above $25^\circ\text{C}$	$P_D$	783	mW
		6.3	mW/ $^\circ\text{C}$
Thermal Resistance, Junction-to-Ambient (Note 2)	$R_{\theta JA}$	160	$^\circ\text{C}/\text{W}$
Junction and Storage Temperature Range	$T_J, T_{stg}$	-55 to +150	$^\circ\text{C}$

1. FR-4 @ 10 mm<sup>2</sup>, 1 oz. copper traces, still air.
2. FR-4 @ 100 mm<sup>2</sup>, 1 oz. copper traces, still air.
3. Dual heated values assume total power is the sum of two equally powered devices.

# NSS40302PDR2G

## NPN ELECTRICAL CHARACTERISTICS ( $T_A = 25^\circ\text{C}$ unless otherwise noted)

Characteristic	Symbol	Min	Typ	Max	Unit
----------------	--------	-----	-----	-----	------

### OFF CHARACTERISTICS

Collector – Emitter Breakdown Voltage ( $I_C = 10 \text{ mAdc}$ , $I_B = 0$ )	$V_{(BR)CEO}$	40	–	–	Vdc
Collector – Base Breakdown Voltage ( $I_C = 0.1 \text{ mAdc}$ , $I_E = 0$ )	$V_{(BR)CBO}$	40	–	–	Vdc
Emitter – Base Breakdown Voltage ( $I_E = 0.1 \text{ mAdc}$ , $I_C = 0$ )	$V_{(BR)EBO}$	6.0	–	–	Vdc
Collector Cutoff Current ( $V_{CB} = 40 \text{ Vdc}$ , $I_E = 0$ )	$I_{CBO}$	–	–	0.1	$\mu\text{Adc}$
Emitter Cutoff Current ( $V_{EB} = 6.0 \text{ Vdc}$ )	$I_{EBO}$	–	–	0.1	$\mu\text{Adc}$

### ON CHARACTERISTICS

DC Current Gain (Note 5) ( $I_C = 10 \text{ mA}$ , $V_{CE} = 2.0 \text{ V}$ ) ( $I_C = 500 \text{ mA}$ , $V_{CE} = 2.0 \text{ V}$ ) ( $I_C = 1.0 \text{ A}$ , $V_{CE} = 2.0 \text{ V}$ ) ( $I_C = 2.0 \text{ A}$ , $V_{CE} = 2.0 \text{ V}$ )	$h_{FE}$	200 200 180 180	400 350 340 320	– – – –	
Collector – Emitter Saturation Voltage (Note 5) ( $I_C = 0.1 \text{ A}$ , $I_B = 0.010 \text{ A}$ ) ( $I_C = 1.0 \text{ A}$ , $I_B = 0.100 \text{ A}$ ) ( $I_C = 1.0 \text{ A}$ , $I_B = 0.010 \text{ A}$ ) ( $I_C = 2.0 \text{ A}$ , $I_B = 0.200 \text{ A}$ )	$V_{CE(sat)}$	– – – –	0.008 0.044 0.080 0.082	0.011 0.060 0.115 0.115	V
Base – Emitter Saturation Voltage (Note 5) ( $I_C = 1.0 \text{ A}$ , $I_B = 0.01 \text{ A}$ )	$V_{BE(sat)}$	–	0.780	0.900	V
Base – Emitter Turn-on Voltage (Note 5) ( $I_C = 0.1 \text{ A}$ , $V_{CE} = 2.0 \text{ V}$ )	$V_{BE(on)}$	–	0.650	0.750	V
Cutoff Frequency ( $I_C = 100 \text{ mA}$ , $V_{CE} = 5.0 \text{ V}$ , $f = 100 \text{ MHz}$ )	$f_T$	100	–	–	MHz
Input Capacitance ( $V_{EB} = 0.5 \text{ V}$ , $f = 1.0 \text{ MHz}$ )	$C_{ibo}$	–	320	450	pF
Output Capacitance ( $V_{CB} = 3.0 \text{ V}$ , $f = 1.0 \text{ MHz}$ )	$C_{obo}$	–	40	50	pF

### SWITCHING CHARACTERISTICS

Delay ( $V_{CC} = 30 \text{ V}$ , $I_C = 750 \text{ mA}$ , $I_{B1} = 15 \text{ mA}$ )	$t_d$	–	–	100	ns
Rise ( $V_{CC} = 30 \text{ V}$ , $I_C = 750 \text{ mA}$ , $I_{B1} = 15 \text{ mA}$ )	$t_r$	–	–	100	ns
Storage ( $V_{CC} = 30 \text{ V}$ , $I_C = 750 \text{ mA}$ , $I_{B1} = 15 \text{ mA}$ )	$t_s$	–	–	780	ns
Fall ( $V_{CC} = 30 \text{ V}$ , $I_C = 750 \text{ mA}$ , $I_{B1} = 15 \text{ mA}$ )	$t_f$	–	–	110	ns

4. Pulsed Condition: Pulse Width = 300  $\mu\text{sec}$ , Duty Cycle  $\leq 2\%$ .

# NSS40302PDR2G

## PNP ELECTRICAL CHARACTERISTICS ( $T_A = 25^\circ\text{C}$ unless otherwise noted)

Characteristic	Symbol	Min	Typ	Max	Unit
----------------	--------	-----	-----	-----	------

### OFF CHARACTERISTICS

Collector–Emitter Breakdown Voltage ( $I_C = -10\text{ mA}$ , $I_B = 0$ )	$V_{(BR)CEO}$	-40	-	-	Vdc
Collector–Base Breakdown Voltage ( $I_C = -0.1\text{ mA}$ , $I_E = 0$ )	$V_{(BR)CBO}$	-40	-	-	Vdc
Emitter–Base Breakdown Voltage ( $I_E = -0.1\text{ mA}$ , $I_C = 0$ )	$V_{(BR)EBO}$	-7.0	-	-	Vdc
Collector Cutoff Current ( $V_{CB} = -40\text{ Vdc}$ , $I_E = 0$ )	$I_{CBO}$	-	-	-0.1	$\mu\text{A}$
Emitter Cutoff Current ( $V_{EB} = -6.0\text{ Vdc}$ )	$I_{EBO}$	-	-	-0.1	$\mu\text{A}$

### ON CHARACTERISTICS

DC Current Gain (Note 5) ( $I_C = -10\text{ mA}$ , $V_{CE} = -2.0\text{ V}$ ) ( $I_C = -500\text{ mA}$ , $V_{CE} = -2.0\text{ V}$ ) ( $I_C = -1.0\text{ A}$ , $V_{CE} = -2.0\text{ V}$ ) ( $I_C = -2.0\text{ A}$ , $V_{CE} = -2.0\text{ V}$ )	$h_{FE}$	250 220 180 150	380 340 300 230	- - - -	
Collector–Emitter Saturation Voltage (Note 5) ( $I_C = -0.1\text{ A}$ , $I_B = -0.010\text{ A}$ ) ( $I_C = -1.0\text{ A}$ , $I_B = -0.100\text{ A}$ ) ( $I_C = -1.0\text{ A}$ , $I_B = -0.010\text{ A}$ ) ( $I_C = -2.0\text{ A}$ , $I_B = -0.200\text{ A}$ )	$V_{CE(sat)}$	- - - -	-0.013 -0.075 -0.130 -0.135	-0.017 -0.095 -0.170 -0.170	V
Base–Emitter Saturation Voltage (Note 5) ( $I_C = -1.0\text{ A}$ , $I_B = -0.01\text{ A}$ )	$V_{BE(sat)}$	-	-0.780	-0.900	V
Base–Emitter Turn–on Voltage (Note 5) ( $I_C = -0.1\text{ A}$ , $V_{CE} = -2.0\text{ V}$ )	$V_{BE(on)}$	-	-0.660	-0.750	V
Cutoff Frequency ( $I_C = -100\text{ mA}$ , $V_{CE} = -5.0\text{ V}$ , $f = 100\text{ MHz}$ )	$f_T$	100	-	-	MHz
Input Capacitance ( $V_{EB} = -0.5\text{ V}$ , $f = 1.0\text{ MHz}$ )	$C_{ibo}$	-	250	300	pF
Output Capacitance ( $V_{CB} = -3.0\text{ V}$ , $f = 1.0\text{ MHz}$ )	$C_{obo}$	-	50	65	pF

### SWITCHING CHARACTERISTICS

Delay ( $V_{CC} = -30\text{ V}$ , $I_C = -750\text{ mA}$ , $I_{B1} = -15\text{ mA}$ )	$t_d$	-	-	60	ns
Rise ( $V_{CC} = -30\text{ V}$ , $I_C = -750\text{ mA}$ , $I_{B1} = -15\text{ mA}$ )	$t_r$	-	-	120	ns
Storage ( $V_{CC} = -30\text{ V}$ , $I_C = -750\text{ mA}$ , $I_{B1} = -15\text{ mA}$ )	$t_s$	-	-	400	ns
Fall ( $V_{CC} = -30\text{ V}$ , $I_C = -750\text{ mA}$ , $I_{B1} = -15\text{ mA}$ )	$t_f$	-	-	130	ns

5. Pulsed Condition: Pulse Width = 300  $\mu\text{sec}$ , Duty Cycle  $\leq 2\%$ .

NPN TYPICAL CHARACTERISTICS

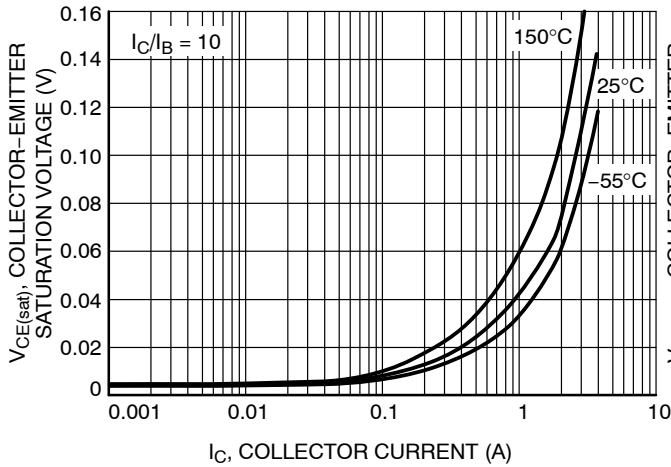

Figure 1. Collector Emitter Saturation Voltage vs. Collector Current

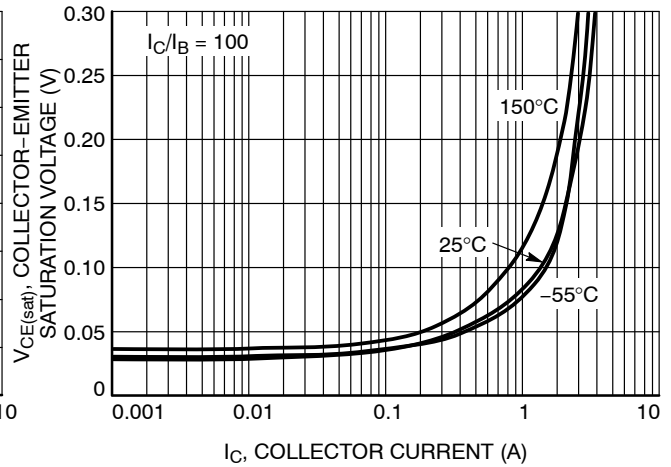

Figure 2. Collector Emitter Saturation Voltage vs. Collector Current

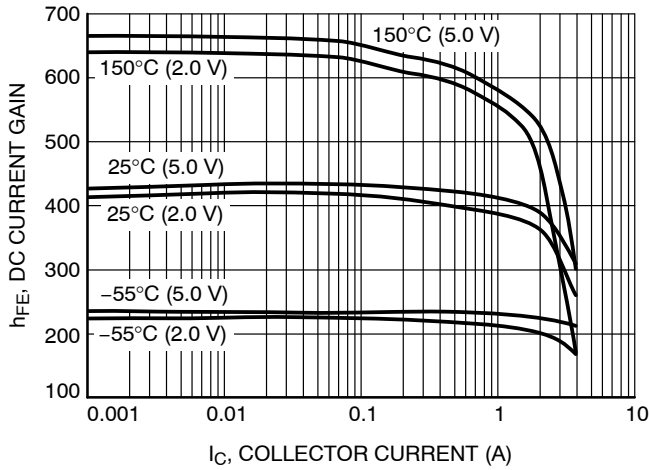

Figure 3. DC Current Gain vs. Collector Current

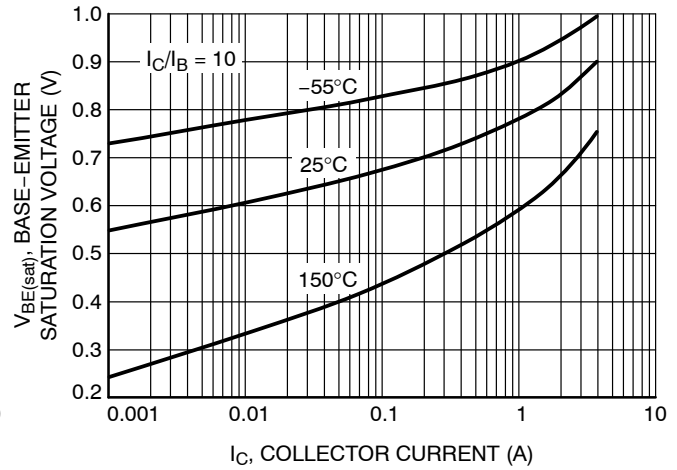

Figure 4. Base Emitter Saturation Voltage vs. Collector Current

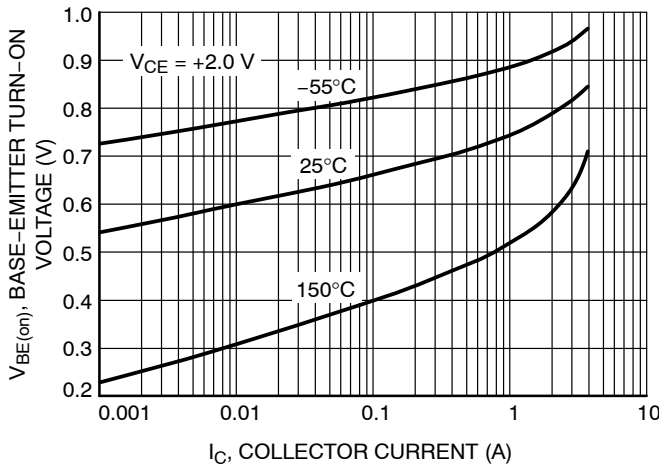

Figure 5. Base Emitter Turn-On Voltage vs. Collector Current

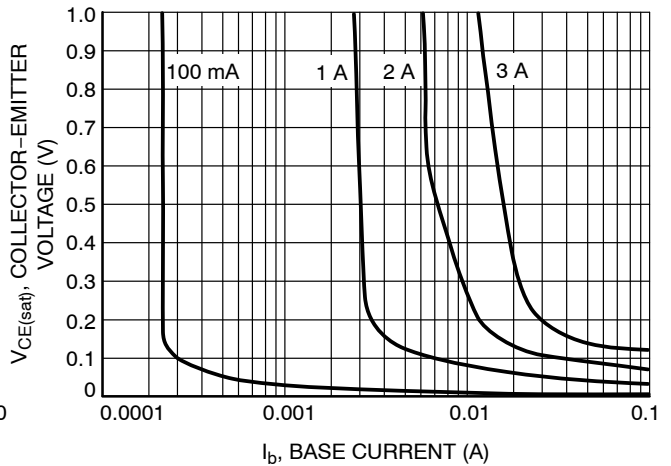

Figure 6. Saturation Region

# NSS40302PDR2G

## NPN TYPICAL CHARACTERISTICS

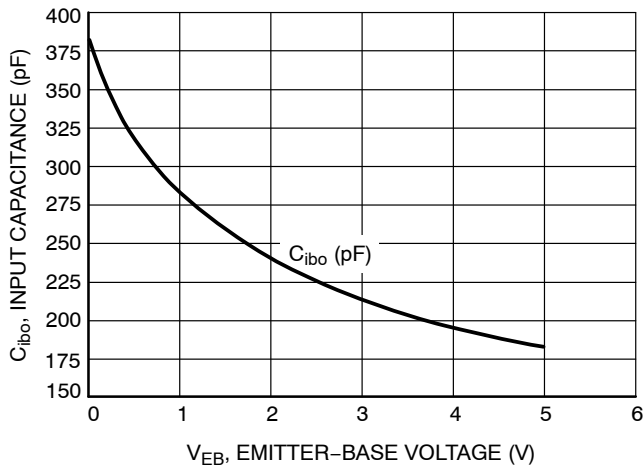

Figure 7. Input Capacitance

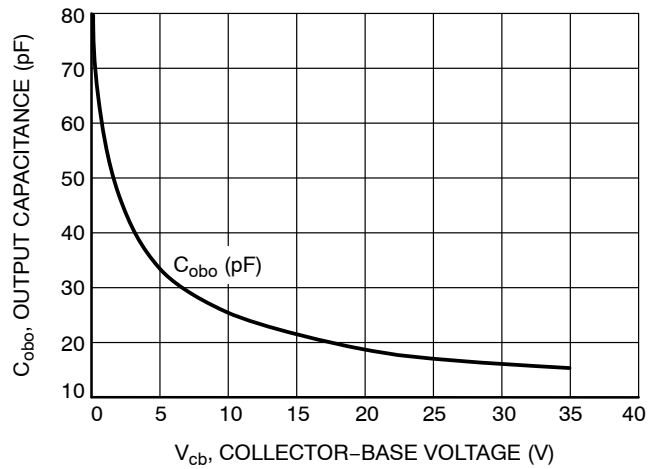

Figure 8. Output Capacitance

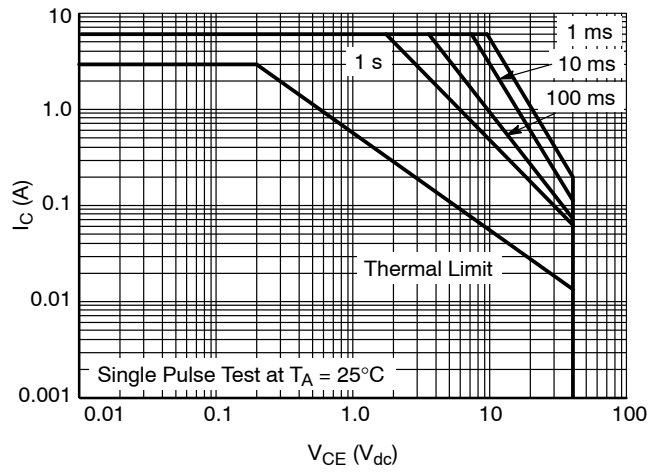

Figure 9. Safe Operating Area

PNP TYPICAL CHARACTERISTICS

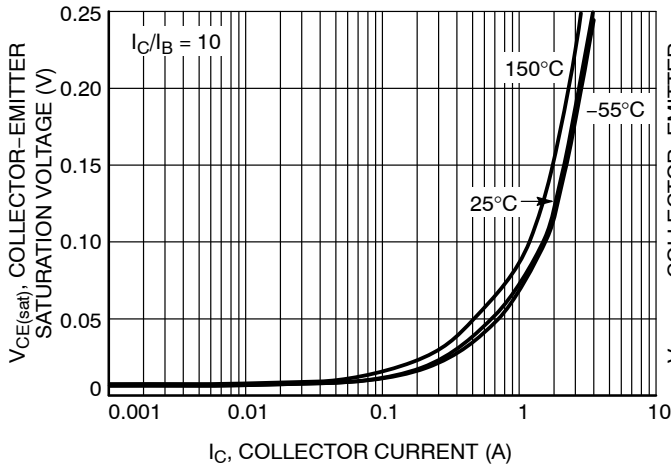

Figure 10. Collector Emitter Saturation Voltage vs. Collector Current

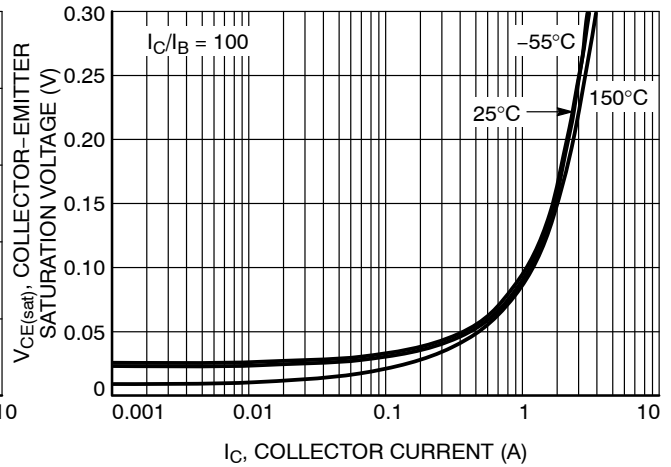

Figure 11. Collector Emitter Saturation Voltage vs. Collector Current

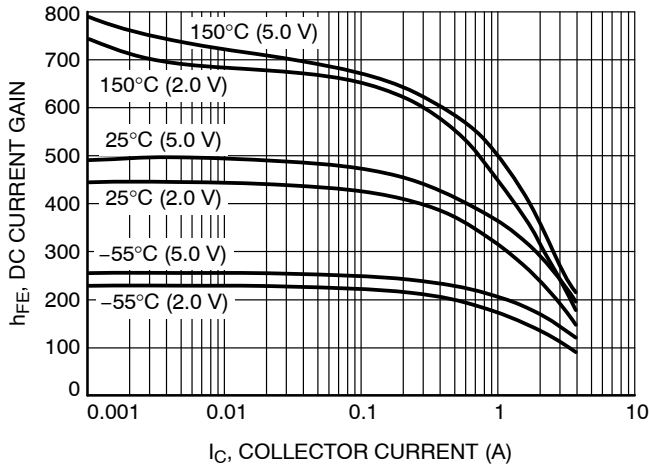

Figure 12. DC Current Gain vs. Collector Current

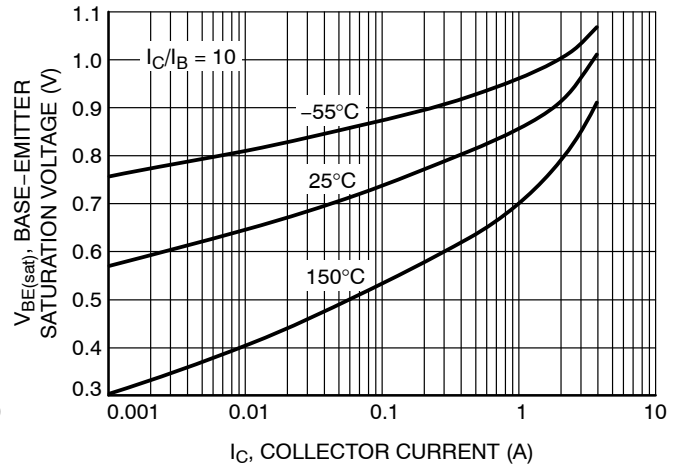

Figure 13. Base Emitter Saturation Voltage vs. Collector Current

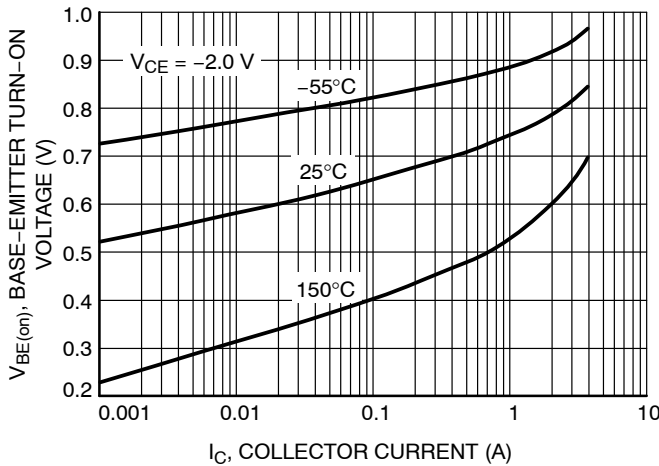

Figure 14. Base Emitter Turn-On Voltage vs. Collector Current

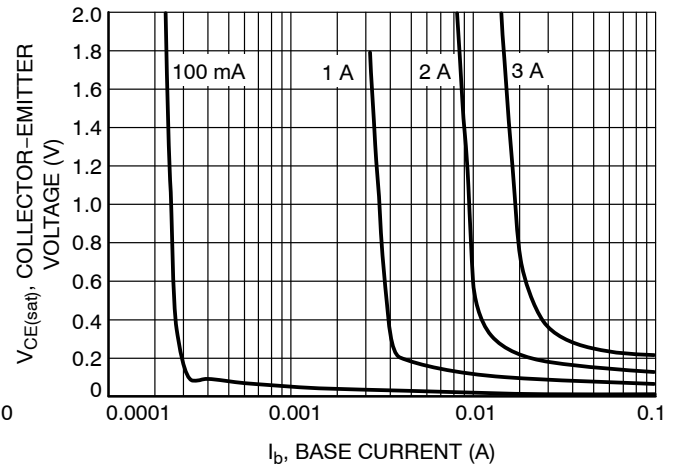

Figure 15. Saturation Region

# NSS40302PDR2G

## PNP TYPICAL CHARACTERISTICS

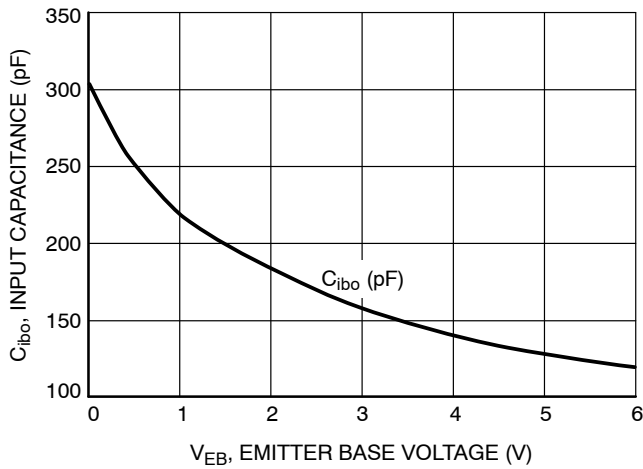

Figure 16. Input Capacitance

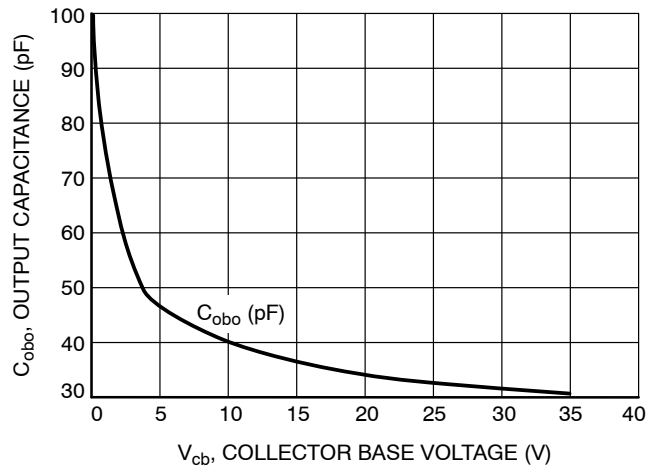

Figure 17. Output Capacitance

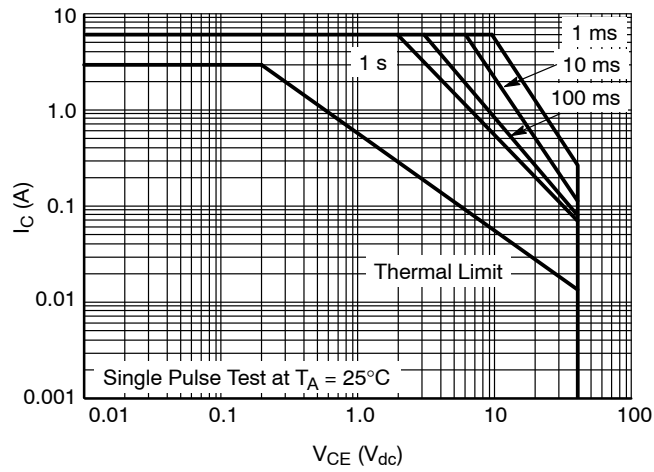

Figure 18. Safe Operating Area



# NSS40302PDR2G

## PACKAGE DIMENSIONS

### SOIC-8 NB CASE 751-07 ISSUE AJ

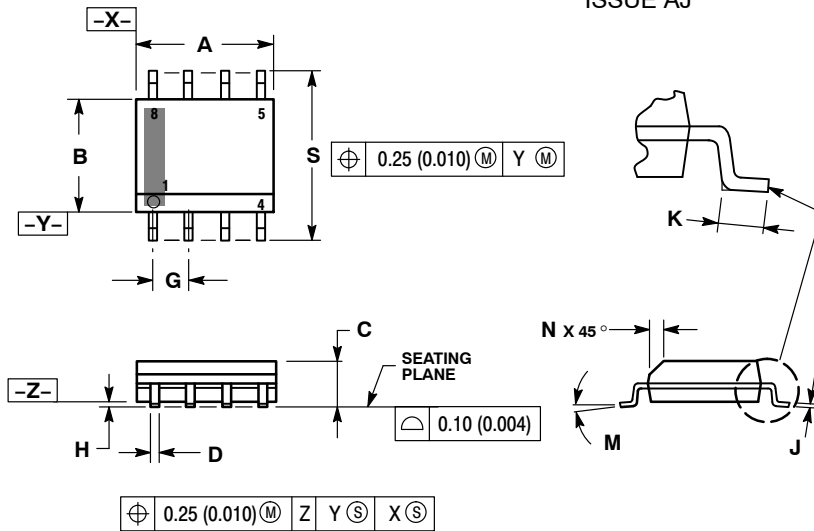

#### NOTES:

1. DIMENSIONING AND TOLERANCING PER ANSI Y14.5M, 1982.
2. CONTROLLING DIMENSION: MILLIMETER.
3. DIMENSION A AND B DO NOT INCLUDE MOLD PROTRUSION.
4. MAXIMUM MOLD PROTRUSION 0.15 (0.006) PER SIDE.
5. DIMENSION D DOES NOT INCLUDE DAMBAR PROTRUSION. ALLOWABLE DAMBAR PROTRUSION SHALL BE 0.127 (0.005) TOTAL IN EXCESS OF THE D DIMENSION AT MAXIMUM MATERIAL CONDITION.
6. 751-01 THRU 751-06 ARE OBSOLETE. NEW STANDARD IS 751-07.

DIM	MILLIMETERS		INCHES	
	MIN	MAX	MIN	MAX
A	4.80	5.00	0.189	0.197
B	3.80	4.00	0.150	0.157
C	1.35	1.75	0.053	0.069
D	0.33	0.51	0.013	0.020
G	1.27 BSC		0.050 BSC	
H	0.10	0.25	0.004	0.010
J	0.19	0.25	0.007	0.010
K	0.40	1.27	0.016	0.050
M	0°	8°	0°	8°
N	0.25	0.50	0.010	0.020
S	5.80	6.20	0.228	0.244

### SOLDERING FOOTPRINT\*

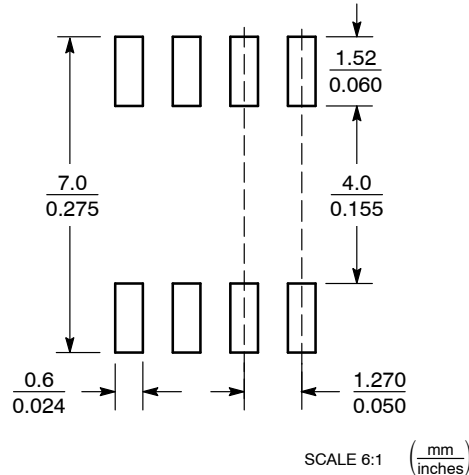

#### STYLE 16:

1. EMITTER, DIE #1
2. BASE, DIE #1
3. EMITTER, DIE #2
4. BASE, DIE #2
5. COLLECTOR, DIE #2
6. COLLECTOR, DIE #1
7. COLLECTOR, DIE #1
8. COLLECTOR, DIE #1

\*For additional information on our Pb-Free strategy and soldering details, please download the ON Semiconductor Soldering and Mounting Techniques Reference Manual, SOLDERRM/D.

ON Semiconductor and are registered trademarks of Semiconductor Components Industries, LLC (SCILLC). SCILLC reserves the right to make changes without further notice to any products herein. SCILLC makes no warranty, representation or guarantee regarding the suitability of its products for any particular purpose, nor does SCILLC assume any liability arising out of the application or use of any product or circuit, and specifically disclaims any and all liability, including without limitation special, consequential or incidental damages. "Typical" parameters which may be provided in SCILLC data sheets and/or specifications can and do vary in different applications and actual performance may vary over time. All operating parameters, including "Typicals" must be validated for each customer application by customer's technical experts. SCILLC does not convey any license under its patent rights nor the rights of others. SCILLC products are not designed, intended, or authorized for use as components in systems intended for surgical implant into the body, or other applications intended to support or sustain life, or for any other application in which the failure of the SCILLC product could create a situation where personal injury or death may occur. Should Buyer purchase or use SCILLC products for any such unintended or unauthorized application, Buyer shall indemnify and hold SCILLC and its officers, employees, subsidiaries, affiliates, and distributors harmless against all claims, costs, damages, and expenses, and reasonable attorney fees arising out of, directly or indirectly, any claim of personal injury or death associated with such unintended or unauthorized use, even if such claim alleges that SCILLC was negligent regarding the design or manufacture of the part. SCILLC is an Equal Opportunity/Affirmative Action Employer. This literature is subject to all applicable copyright laws and is not for resale in any manner.

### PUBLICATION ORDERING INFORMATION

#### LITERATURE FULFILLMENT:

Literature Distribution Center for ON Semiconductor  
P.O. Box 5163, Denver, Colorado 80217 USA  
Phone: 303-675-2175 or 800-344-3860 Toll Free USA/Canada  
Fax: 303-675-2176 or 800-344-3867 Toll Free USA/Canada  
Email: orderlit@onsemi.com

N. American Technical Support: 800-282-9855 Toll Free  
USA/Canada  
Europe, Middle East and Africa Technical Support:  
Phone: 421 33 790 2910  
Japan Customer Focus Center  
Phone: 81-3-5773-3850

ON Semiconductor Website: [www.onsemi.com](http://www.onsemi.com)

Order Literature: <http://www.onsemi.com/orderlit>

For additional information, please contact your local Sales Representative

NSS40302P/D