

XPT™ 600V GenX3™ w/ Diode

IXXH50N60C3D1

Extreme Light Punch Through
IGBT for 20-60 kHz Switching

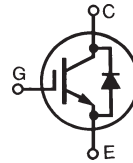

$$\begin{aligned} V_{CES} &= 600V \\ I_{C110} &= 50A \\ V_{CE(sat)} &\leq 2.30V \\ t_{fi(typ)} &= 42ns \end{aligned}$$

Symbol	Test Conditions	Maximum Ratings	
V_{CES}	$T_J = 25^\circ\text{C}$ to 175°C	600	V
V_{CGR}	$T_J = 25^\circ\text{C}$ to 175°C , $R_{GE} = 1\text{M}\Omega$	600	V
V_{GES}	Continuous	± 20	V
V_{GEM}	Transient	± 30	V
I_{C25}	$T_C = 25^\circ\text{C}$	100	A
I_{C110}	$T_C = 110^\circ\text{C}$	50	A
I_{F110}	$T_C = 110^\circ\text{C}$	30	A
I_{CM}	$T_C = 25^\circ\text{C}$, 1ms	200	A
I_A	$T_C = 25^\circ\text{C}$	25	A
E_{AS}	$T_C = 25^\circ\text{C}$	200	mJ
SSOA (RBSOA)	$V_{GE} = 15\text{V}$, $T_{VJ} = 150^\circ\text{C}$, $R_G = 5\Omega$ Clamped Inductive Load	$I_{CM} = 100$ @ $\leq V_{CES}$	A
t_{sc} (SCSOA)	$V_{GE} = 15\text{V}$, $V_{CE} = 360\text{V}$, $T_J = 150^\circ\text{C}$ $R_G = 22\Omega$, Non Repetitive	10	μs
P_C	$T_C = 25^\circ\text{C}$	600	W
T_J		-55 ... +175	$^\circ\text{C}$
T_{JM}		175	$^\circ\text{C}$
T_{stg}		-55 ... +175	$^\circ\text{C}$
T_L	Maximum Lead Temperature for Soldering	300	$^\circ\text{C}$
T_{SOLD}	1.6 mm (0.062in.) from Case for 10s	260	$^\circ\text{C}$
M_d	Mounting Torque	1.13/10	Nm/lb.in.
Weight		6	g

TO-247 AD

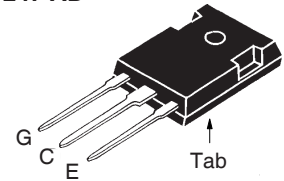

G = Gate C = Collector
E = Emitter Tab = Collector

Features

- Optimized for 20-60kHz Switching
- Square RBSOA
- Anti-Parallel Ultra Fast Diode
- Avalanche Capability
- Short Circuit Capability
- International Standard Package

Advantages

- High Power Density
- 175°C Rated
- Extremely Rugged
- Low Gate Drive Requirement

Applications

- Power Inverters
- UPS
- Motor Drives
- SMPS
- PFC Circuits
- Battery Chargers
- Welding Machines
- Lamp Ballasts

Symbol	Test Conditions ($T_J = 25^\circ\text{C}$, Unless Otherwise Specified)	Characteristic Values		
		Min.	Typ.	Max.
BV_{CES}	$I_C = 250\mu\text{A}$, $V_{GE} = 0\text{V}$	600		V
$V_{GE(th)}$	$I_C = 250\mu\text{A}$, $V_{CE} = V_{GE}$	3.0		5.5 V
I_{CES}	$V_{CE} = V_{CES}$, $V_{GE} = 0\text{V}$ $T_J = 150^\circ\text{C}$			25 μA 3 mA
I_{GES}	$V_{CE} = 0\text{V}$, $V_{GE} = \pm 20\text{V}$			± 100 nA
$V_{CE(sat)}$	$I_C = 36\text{A}$, $V_{GE} = 15\text{V}$, Note 1 $T_J = 150^\circ\text{C}$	1.95	2.30	V
		2.45		V

Symbol Test Conditions ($T_J = 25^\circ\text{C}$ Unless Otherwise Specified)		Characteristic Values		
		Min.	Typ.	Max.
g_{fs}	$I_C = 36\text{A}, V_{CE} = 10\text{V}, \text{Note 1}$	11	18	S
C_{ies}	$V_{CE} = 25\text{V}, V_{GE} = 0\text{V}, f = 1\text{MHz}$		2320	pF
C_{oes}			138	pF
C_{res}			42	pF
Q_g	$I_C = 36\text{A}, V_{GE} = 15\text{V}, V_{CE} = 0.5 \cdot V_{CES}$		64	nC
Q_{ge}			18	nC
Q_{gc}			25	nC
$t_{d(on)}$	Inductive load, $T_J = 25^\circ\text{C}$ $I_C = 36\text{A}, V_{GE} = 15\text{V}$ $V_{CE} = 360\text{V}, R_G = 5\Omega$ Note 2		24	ns
t_{ri}			40	ns
E_{on}			0.72	mJ
$t_{d(off)}$			62	100 ns
t_{fi}			42	ns
E_{off}			0.33	0.55 mJ
$t_{d(on)}$	Inductive load, $T_J = 150^\circ\text{C}$ $I_C = 36\text{A}, V_{GE} = 15\text{V}$ $V_{CE} = 360\text{V}, R_G = 5\Omega$ Note 2		25	ns
t_{ri}			44	ns
E_{on}			1.46	mJ
$t_{d(off)}$			80	ns
t_{fi}			90	ns
E_{off}			0.48	mJ
R_{thJC}			0.25	$^\circ\text{C/W}$
R_{thCS}		0.21		$^\circ\text{C/W}$

TO-247 (IXXH) Outline

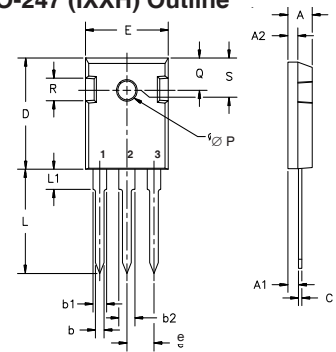

Terminals: 1 - Gate 2 - Collector
3 - Emitted

Dim.	Millimeter		Inches	
	Min.	Max.	Min.	Max.
A	4.7	5.3	.185	.209
A ₁	2.2	2.54	.087	.102
A ₂	2.2	2.6	.059	.098
b	1.0	1.4	.040	.055
b ₁	1.65	2.13	.065	.084
b ₂	2.87	3.12	.113	.123
C	.4	.8	.016	.031
D	20.80	21.46	.819	.845
E	15.75	16.26	.610	.640
e	5.20	5.72	0.205	0.225
L	19.81	20.32	.780	.800
L1		4.50		.177
∅P	3.55	3.65	.140	.144
Q	5.89	6.40	0.232	0.252
R	4.32	5.49	.170	.216
S	6.15	BSC	242	BSC

Reverse Diode (FRED)

Symbol Test Conditions ($T_J = 25^\circ\text{C}$ Unless Otherwise Specified)		Characteristic Values		
		Min.	Typ.	Max.
V_F	$I_F = 24\text{A}, V_{GE} = 0\text{V}, \text{Note 1}$			2.7 V
		$T_J = 150^\circ\text{C}$	1.6	V
I_{RM}	$I_F = 30\text{A}, V_{GE} = 0\text{V}, -di_F/dt = 100\text{A}/\mu\text{s},$	$T_J = 100^\circ\text{C}$		4 A
t_{rr}	$V_R = 100\text{V}$	$T_J = 100^\circ\text{C}$	100	ns
	$I_F = 1\text{A}, V_{GE} = 0\text{V}, -di_F/dt = 100\text{A}/\mu\text{s}, V_R = 30\text{V}$		25	ns
R_{thJC}				0.9 $^\circ\text{C/W}$

Notes:

1. Pulse test, $t \leq 300\mu\text{s}$, duty cycle, $d \leq 2\%$.
2. Switching times & energy losses may increase for higher V_{CE} (clamp), T_J or R_G .

ADVANCE TECHNICAL INFORMATION

The product presented herein is under development. The Technical Specifications offered are derived from a subjective evaluation of the design, based upon prior knowledge and experience, and constitute a "considered reflection" of the anticipated result. IXYS reserves the right to change limits, test conditions, and dimensions without notice.

IXYS Reserves the Right to Change Limits, Test Conditions, and Dimensions.

IXYS MOSFETs and IGBTs are covered by one or more of the following U.S. patents:	4,835,592	4,931,844	5,049,961	5,237,481	6,162,665	6,404,065 B1	6,683,344	6,727,585	7,005,734 B2	7,157,338B2
	4,850,072	5,017,508	5,063,307	5,381,025	6,259,123 B1	6,534,343	6,710,405 B2	6,759,692	7,063,975 B2	
	4,881,106	5,034,796	5,187,117	5,486,715	6,306,728 B1	6,583,505	6,710,463	6,771,478 B2	7,071,537	

Fig. 1. Output Characteristics @ $T_J = 25^\circ\text{C}$

Fig. 2. Extended Output Characteristics @ $T_J = 25^\circ\text{C}$

Fig. 3. Output Characteristics @ $T_J = 150^\circ\text{C}$

Fig. 4. Dependence of $V_{CE(sat)}$ on Junction Temperature

Fig. 5. Collector-to-Emitter Voltage vs. Gate-to-Emitter Voltage

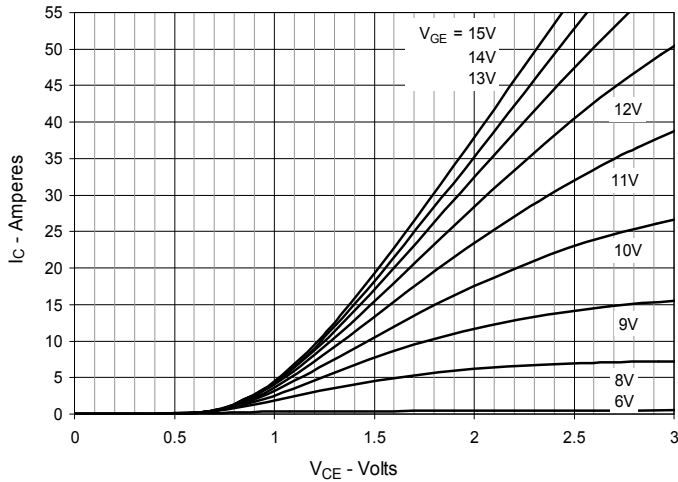
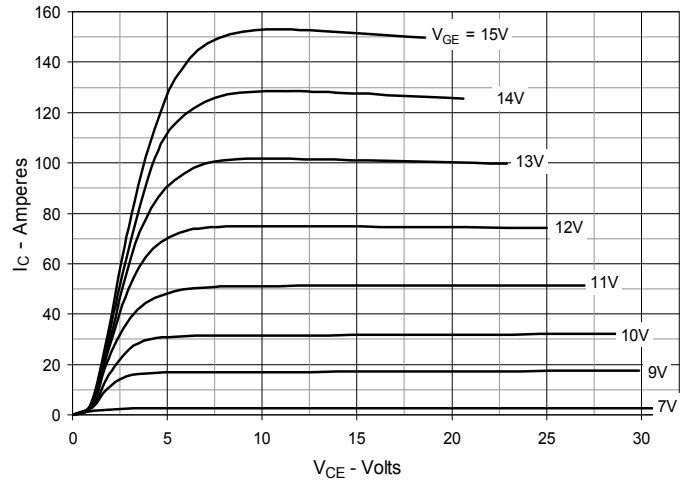
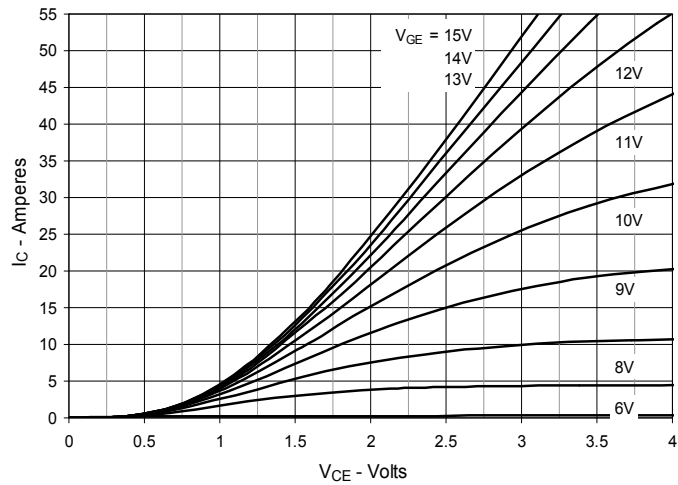
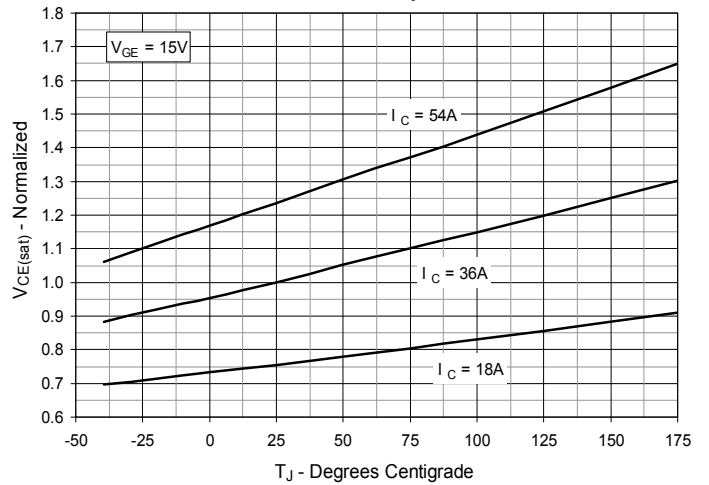
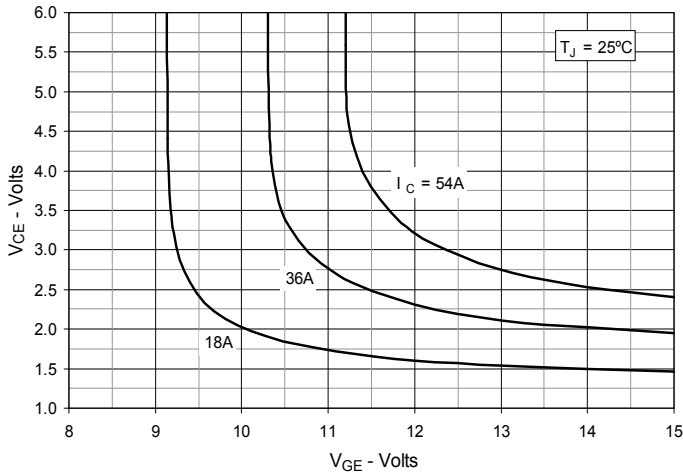
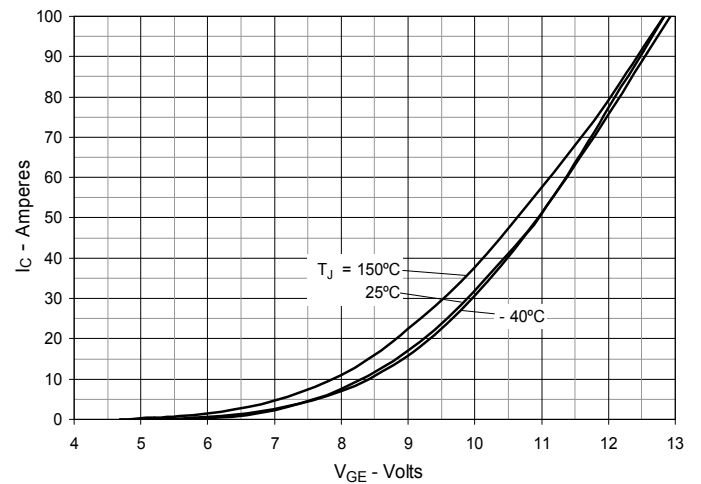
Fig. 6. Input Admittance

Fig. 7. Transconductance

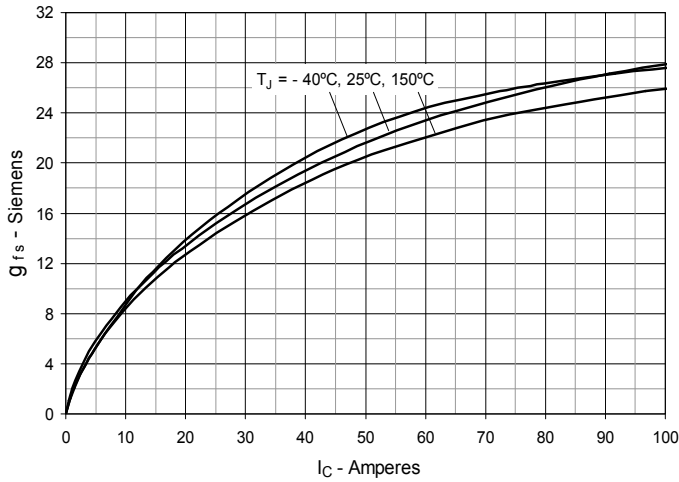

Fig. 8. Gate Charge

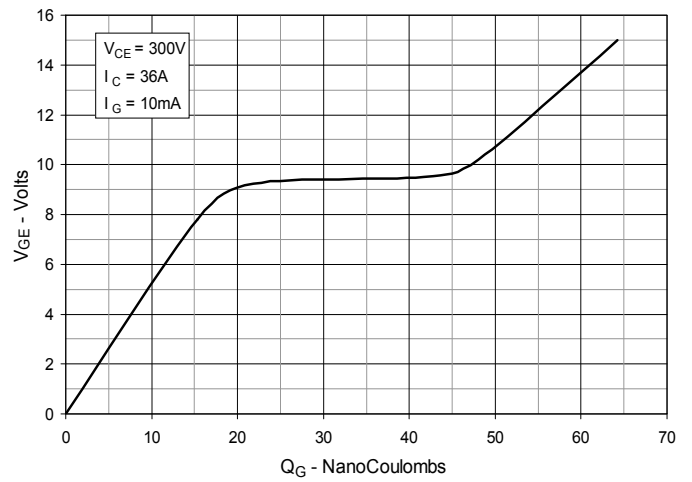

Fig. 9. Capacitance

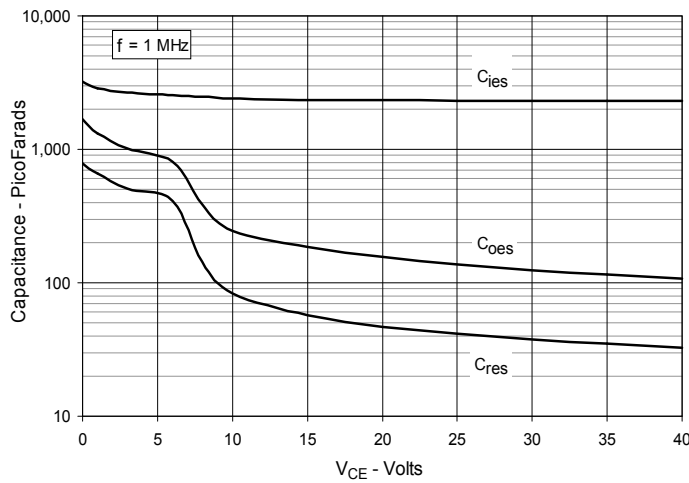

Fig. 10. Reverse-Bias Safe Operating Area

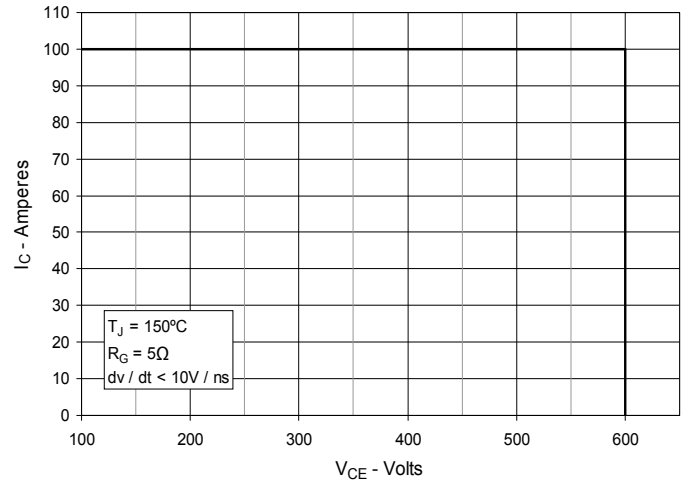

Fig. 11. Forward-Bias Safe Operating Area

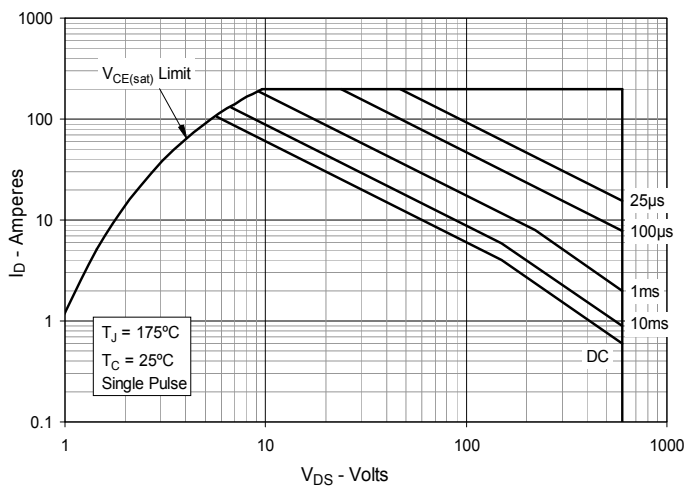
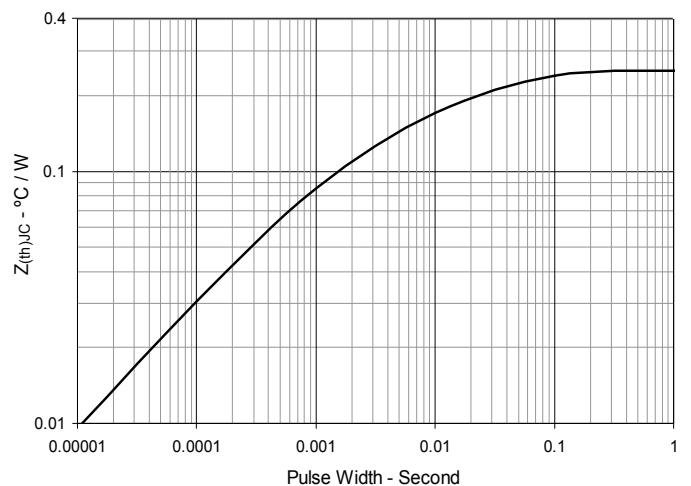

Fig. 12. Maximum Transient Thermal Impedance



IXYS Reserves the Right to Change Limits, Test Conditions, and Dimensions.

Fig. 13. Inductive Switching Energy Loss vs. Gate Resistance

Fig. 14. Inductive Switching Energy Loss vs. Collector Current

Fig. 15. Inductive Switching Energy Loss vs. Junction Temperature

Fig. 16. Inductive Turn-off Switching Times vs. Gate Resistance

Fig. 17. Inductive Turn-off Switching Times vs. Collector Current

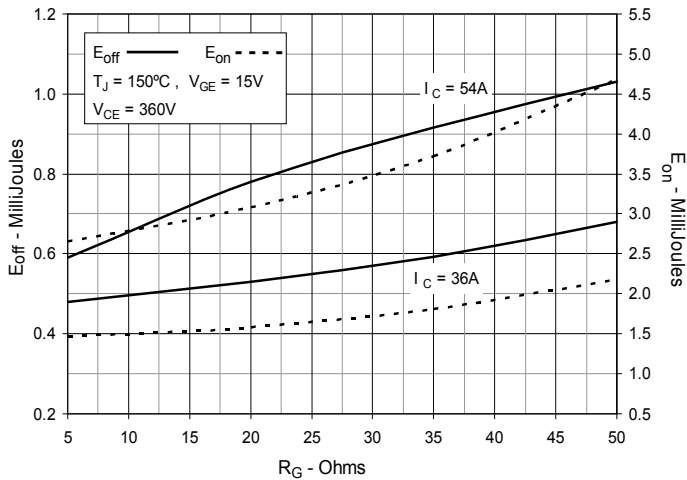
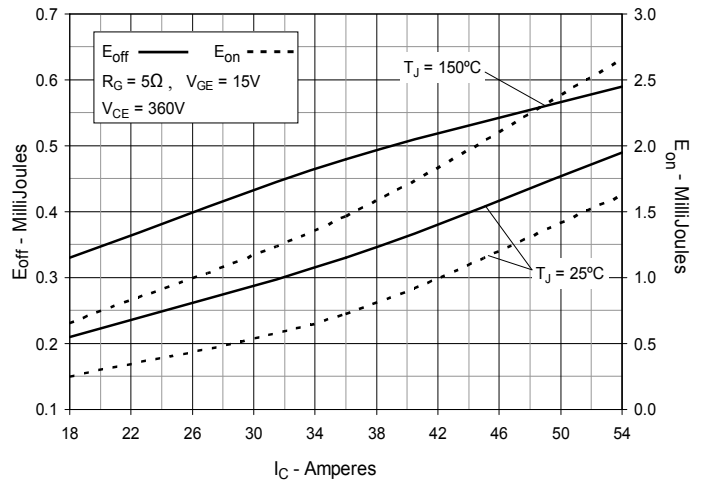
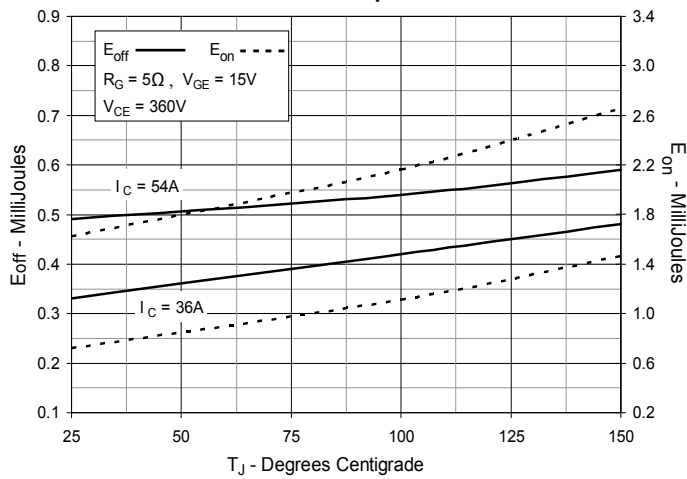
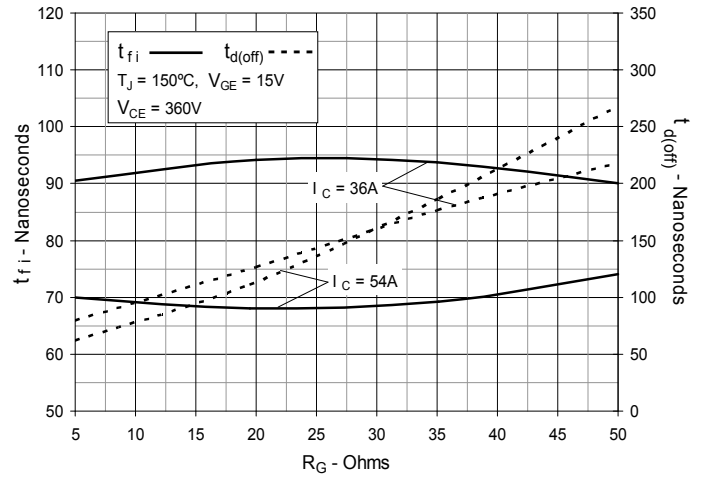
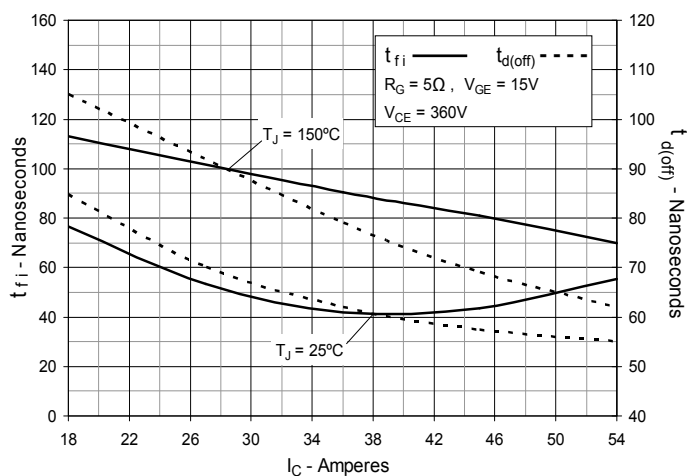
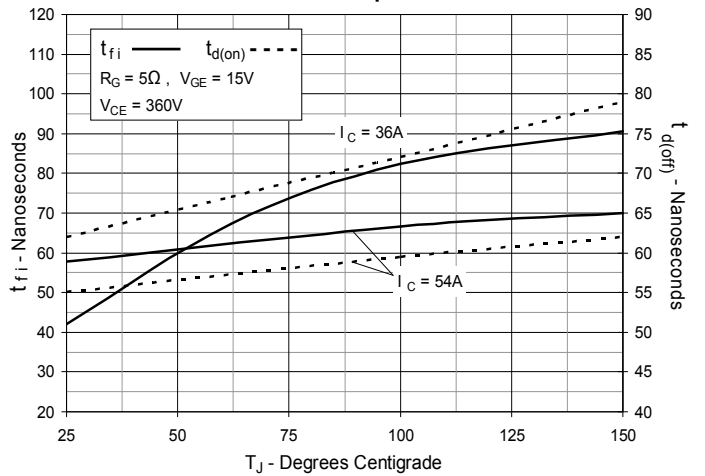
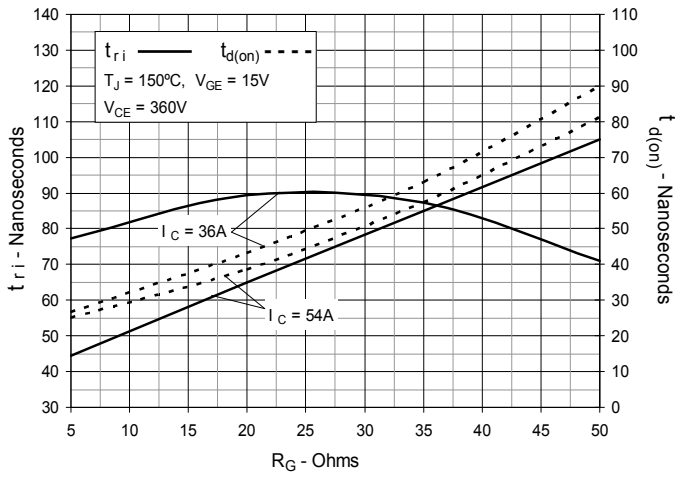
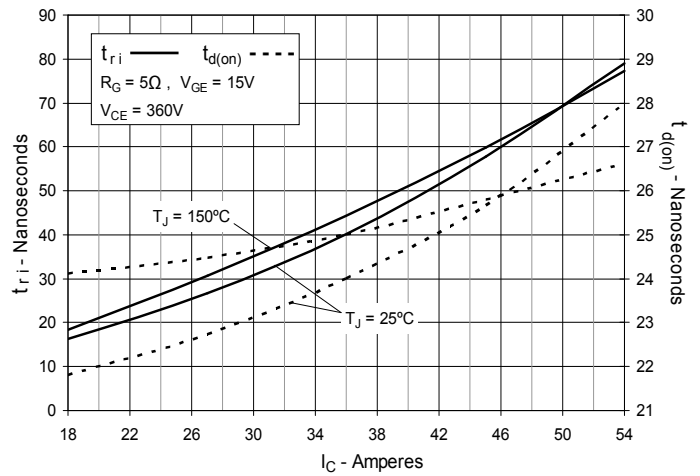
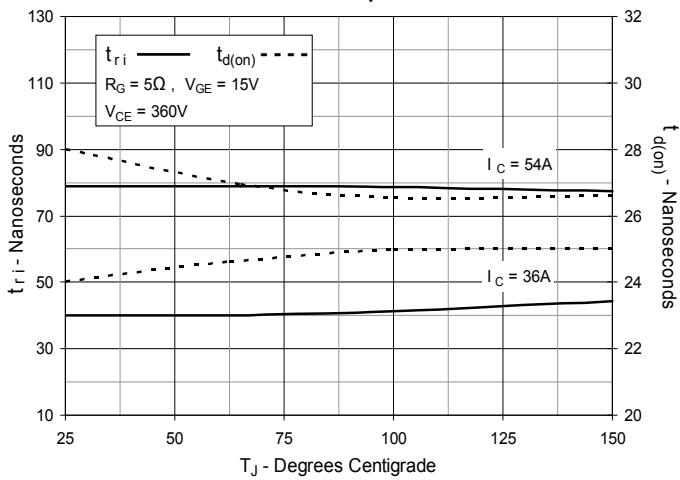
Fig. 18. Inductive Turn-off Switching Times vs. Junction Temperature

Fig. 19. Inductive Turn-on Switching Times vs. Gate Resistance

Fig. 20. Inductive Turn-on Switching Times vs. Collector Current

Fig. 21. Inductive Turn-on Switching Times vs. Junction Temperature

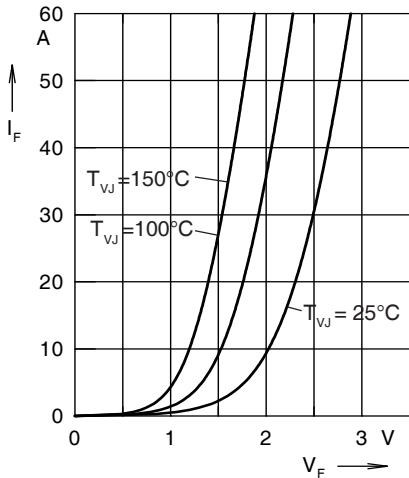

Fig. 22. Forward Current I_F Versus V_F

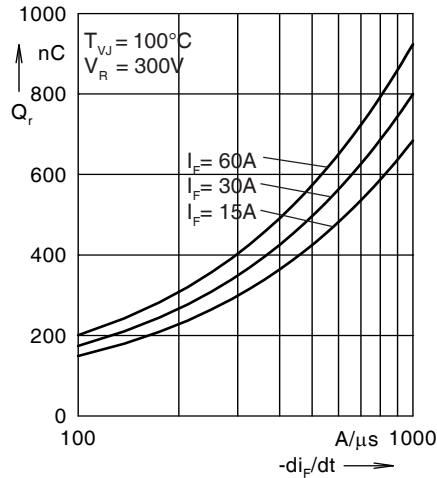

Fig. 23. Reverse Recovery Charge Q_r Versus $-di_F/dt$

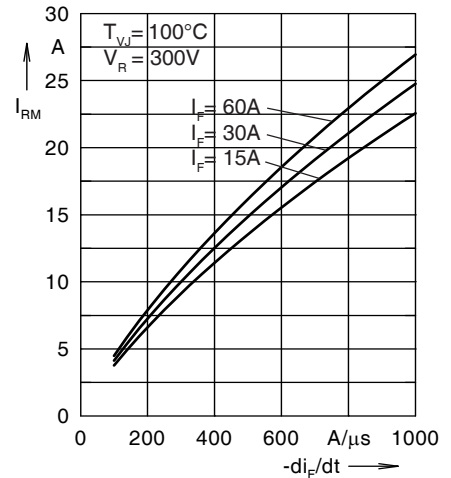

Fig. 24. Peak Reverse Current I_{RM} Versus $-di_F/dt$

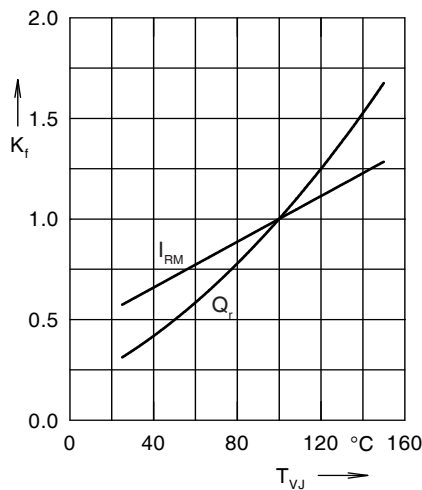

Fig. 25. Dynamic Parameters Q_r , I_{RM} Versus T_{VJ}

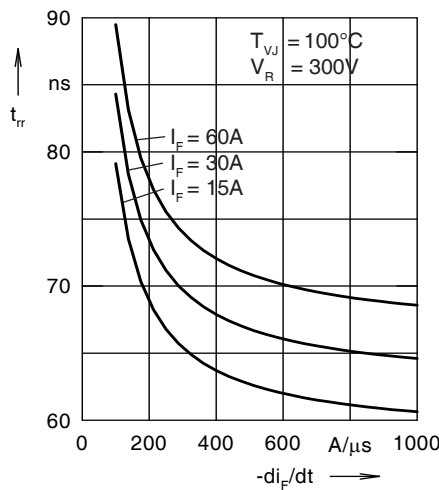

Fig. 26. Recovery Time t_{rr} Versus $-di_F/dt$

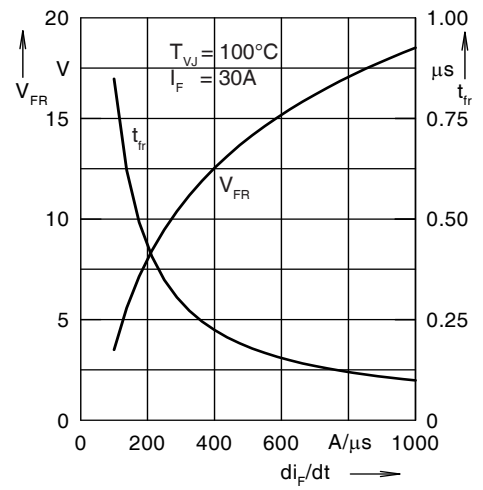

Fig. 27. Peak Forward Voltage V_{FR} and t_{fr} Versus di_F/dt

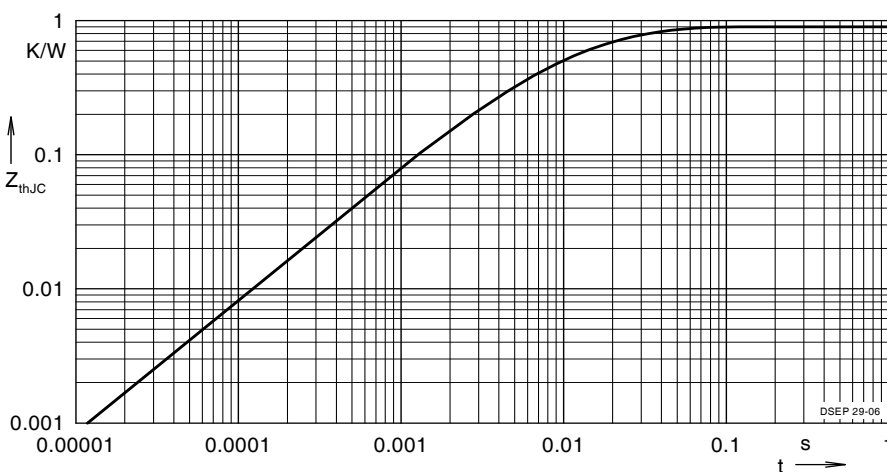

Fig. 28. Transient Thermal Resistance Junction to Case

Constants for Z_{thJC} calculation:

i	R_{thi} (K/W)	t_i (s)
1	0.502	0.0052
2	0.193	0.0003
3	0.205	0.0162