

AUIRFB4410

HEXFET® Power MOSFET

Features

- Advanced Process Technology
- Ultra Low On-Resistance
- Dynamic dV/dT Rating
- 175°C Operating Temperature
- Fast Switching
- Repetitive Avalanche Allowed up to Tjmax
- Lead-Free, RoHS Compliant
- Automotive Qualified *

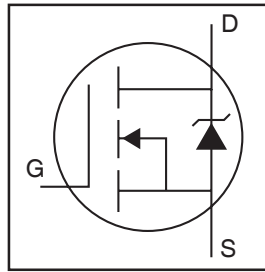

V_{DSS}	100V
R_{DS(on)} typ. max.	8.0mΩ
	10mΩ
I_D (Silicon Limited)	88A
I_D (Package Limited)	75A

Description

Specifically designed for Automotive applications, this HEXFET® Power MOSFET utilizes the latest processing techniques to achieve extremely low on-resistance per silicon area. Additional features of this design are a 175°C junction operating temperature, fast switching speed and improved repetitive avalanche rating. These features combine to make this design an extremely efficient and reliable device for use in Automotive applications and a wide variety of other applications.

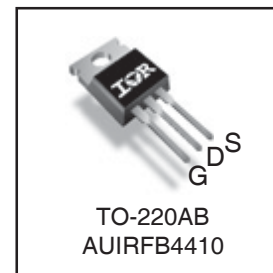

G	D	S
Gate	Drain	Source

Absolute Maximum Ratings

Stresses beyond those listed under "Absolute Maximum Ratings" may cause permanent damage to the device. These are stress ratings only; and functional operation of the device at these or any other condition beyond those indicated in the specifications is not implied. Exposure to absolute-maximum-rated conditions for extended periods may affect device reliability. The thermal resistance and power dissipation ratings are measured under board mounted and still air conditions. Ambient temperature (T_A) is 25°C, unless otherwise specified.

Symbol	Parameter	Max.	Units
I _D @ T _C = 25°C	Continuous Drain Current, V _{GS} @ 10V (Silicon Limited)	88①	A
I _D @ T _C = 100°C	Continuous Drain Current, V _{GS} @ 10V	63	
I _D @ T _C = 25°C	Continuous Drain Current, V _{GS} @ 10V (Package Limited)	75	
I _{DM}	Pulsed Drain Current ②	380	
P _D @ T _C = 25°C	Maximum Power Dissipation	200	W
	Linear Derating Factor	1.3	W/°C
V _{GS}	Gate-to-Source Voltage	± 20	V
dv/dt	Peak Diode Recovery ④	19	V/ns
T _J	Operating Junction and Storage Temperature Range	-55 to + 175	°C
T _{STG}			
	Soldering Temperature, for 10 seconds (1.6mm from case)	300	
	Mounting torque, 6-32 or M3 screw	10lb·in (1.1N·m)	

Avalanche Characteristics

E _{AS} (Thermally limited)	Single Pulse Avalanche Energy ③	220	mJ
I _{AR}	Avalanche Current ①	See Fig. 14, 15, 16a, 16b	A
E _{AR}	Repetitive Avalanche Energy ⑤		mJ

Thermal Resistance

Symbol	Parameter	Typ.	Max.	Units
R _{θJC}	Junction-to-Case ⑥	—	0.61	°C/W
R _{θCS}	Case-to-Sink, Flat Greased Surface	0.50	—	
R _{θJA}	Junction-to-Ambient	—	62	

HEXFET® is a registered trademark of International Rectifier.

*Qualification standards can be found at <http://www.irf.com/>

Static Electrical Characteristics @ T_J = 25°C (unless otherwise specified)

Symbol	Parameter	Min.	Typ.	Max.	Units	Conditions
V _{(BR)DSS}	Drain-to-Source Breakdown Voltage	100	—	—	V	V _{GS} = 0V, I _D = 250μA
ΔV _{(BR)DSS} /ΔT _J	Breakdown Voltage Temp. Coefficient	—	0.094	—	V/°C	Reference to 25°C, I _D = 1mA ^②
R _{DS(on)}	Static Drain-to-Source On-Resistance	—	8.0	10	mΩ	V _{GS} = 10V, I _D = 58A ^③
V _{GS(th)}	Gate Threshold Voltage	2.0	—	4.0	V	V _{DS} = V _{GS} , I _D = 150μA
g _{fs}	Forward Transconductance	120	—	—	S	V _{DS} = 50V, I _D = 58A
R _G	Gate Input Resistance	—	1.5	—	Ω	f = 1MHz, open drain
I _{DSS}	Drain-to-Source Leakage Current	—	—	20	μA	V _{DS} = 100V, V _{GS} = 0V
		—	—	250		V _{DS} = 100V, V _{GS} = 0V, T _J = 125°C
I _{GSS}	Gate-to-Source Forward Leakage	—	—	200	nA	V _{GS} = 20V
	Gate-to-Source Reverse Leakage	—	—	-200		V _{GS} = -20V

Dynamic Electrical Characteristics @ T_J = 25°C (unless otherwise specified)

Symbol	Parameter	Min.	Typ.	Max.	Units	Conditions
Q _g	Total Gate Charge	—	120	180	nC	I _D = 58A
Q _{gs}	Gate-to-Source Charge	—	31	—		V _{DS} = 80V
Q _{gd}	Gate-to-Drain ("Miller") Charge	—	44	—		V _{GS} = 10V ^⑤
t _{d(on)}	Turn-On Delay Time	—	24	—	ns	V _{DD} = 65V
t _r	Rise Time	—	80	—		I _D = 58A
t _{d(off)}	Turn-Off Delay Time	—	55	—		R _G = 4.1Ω
t _f	Fall Time	—	50	—		V _{GS} = 10V ^⑤
C _{iss}	Input Capacitance	—	5150	—	pF	V _{GS} = 0V
C _{oss}	Output Capacitance	—	360	—		V _{DS} = 50V
C _{riss}	Reverse Transfer Capacitance	—	190	—		f = 1.0MHz
C _{oss} eff. (ER)	Effective Output Capacitance (Energy Related)	—	420	—		V _{GS} = 0V, V _{DS} = 0V to 80V ^⑦ , See Fig.11
C _{oss} eff. (TR)	Effective Output Capacitance (Time Related) ^⑥	—	500	—		V _{GS} = 0V, V _{DS} = 0V to 80V ^⑥ , See Fig. 5

Diode Characteristics

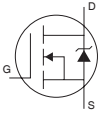
Symbol	Parameter	Min.	Typ.	Max.	Units	Conditions
I _S	Continuous Source Current (Body Diode)	—	—	88 ^①	A	MOSFET symbol showing the integral reverse p-n junction diode. 
I _{SM}	Pulsed Source Current (Body Diode) ^②	—	—	380	A	
V _{SD}	Diode Forward Voltage	—	—	1.3	V	T _J = 25°C, I _S = 58A, V _{GS} = 0V ^⑤
t _{rr}	Reverse Recovery Time	—	38	56	ns	T _J = 25°C V _R = 85V, T _J = 125°C I _F = 58A
Q _{rr}	Reverse Recovery Charge	—	61	92	nC	T _J = 25°C di/dt = 100A/μs ^⑤ T _J = 125°C
I _{RRM}	Reverse Recovery Current	—	2.8	—	A	T _J = 25°C
t _{on}	Forward Turn-On Time	Intrinsic turn-on time is negligible (turn-on is dominated by LS+LD)				

Notes:

- ① Calculated continuous current based on maximum allowable junction temperature. Package limitation current is 75A.
- ② Repetitive rating; pulse width limited by max. junction temperature.
- ③ Limited by T_{Jmax}, starting T_J = 25°C, L = 0.14mH R_G = 25Ω, I_{AS} = 58A, V_{GS} = 10V. Part not recommended for use above this value.
- ④ I_{SD} ≤ 58A, di/dt ≤ 650A/μs, V_{DD} ≤ V_{(BR)DSS}, T_J ≤ 175°C.
- ⑤ Pulse width ≤ 400μs; duty cycle ≤ 2%.
- ⑥ C_{oss} eff. (TR) is a fixed capacitance that gives the same charging time as C_{oss} while V_{DS} is rising from 0 to 80% V_{DSS}.
- ⑦ C_{oss} eff. (ER) is a fixed capacitance that gives the same energy as C_{oss} while V_{DS} is rising from 0 to 80% V_{DSS}.
- ⑧ R_θ is measured at T_J approximately 90°C.

Qualification Information[†]

Qualification Level		Automotive (per AEC-Q101) ^{††}	
		Comments: This part number(s) passed Automotive qualification. IR's Industrial and Consumer qualification level is granted by extension of the higher Automotive level.	
Moisture Sensitivity Level		TO-220AB	N/A
ESD	Machine Model	Class M4 (425V) AEC-Q101-002	
	Human Body Model	Class H1C (2000V) AEC-Q101-001	
	Charged Device Model	Class C5 (1125V) AEC-Q101-005	
RoHS Compliant		Yes	

† Qualification standards can be found at International Rectifier's web site: <http://www.irf.com/>

†† Exceptions to AEC-Q101 requirements are noted in the qualification report.

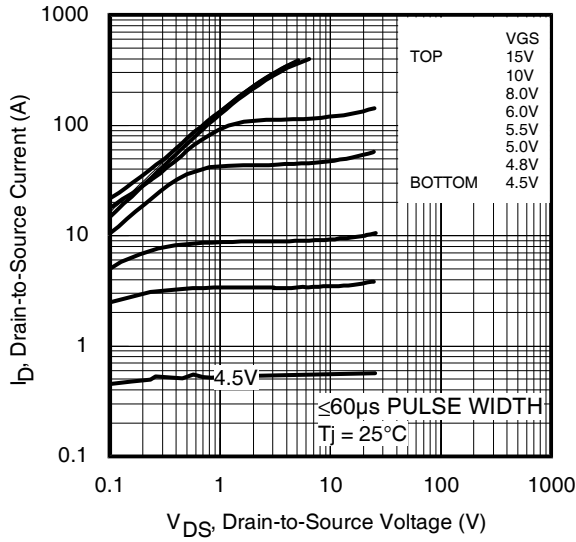

Fig 1. Typical Output Characteristics

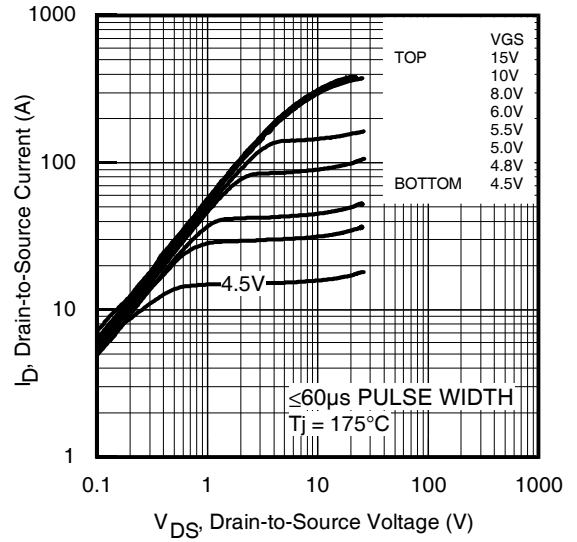

Fig 2. Typical Output Characteristics

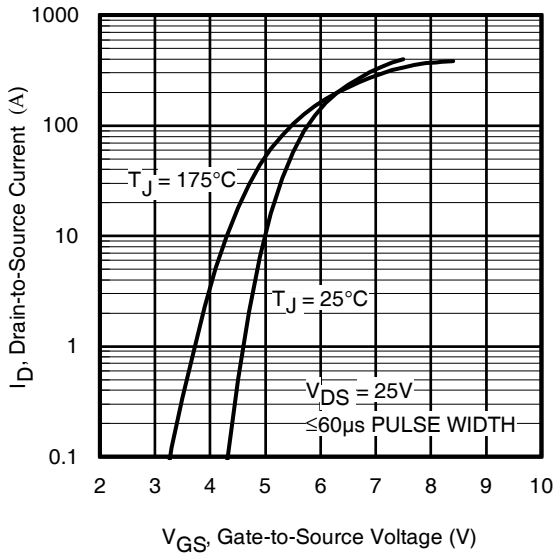

Fig 3. Typical Transfer Characteristics

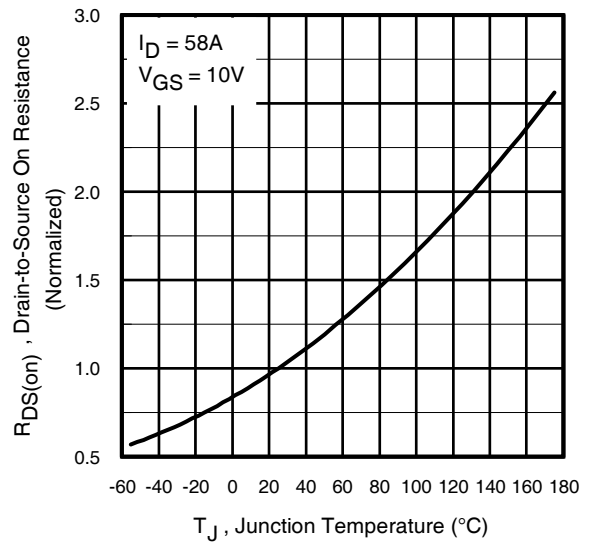

Fig 4. Normalized On-Resistance vs. Temperature

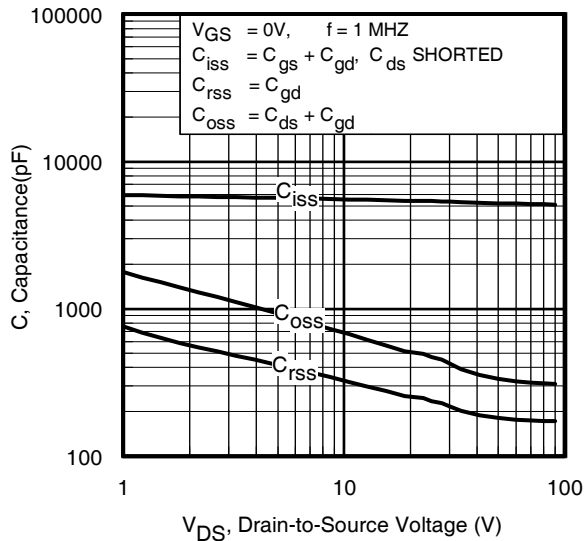

Fig 5. Typical Capacitance vs. Drain-to-Source Voltage

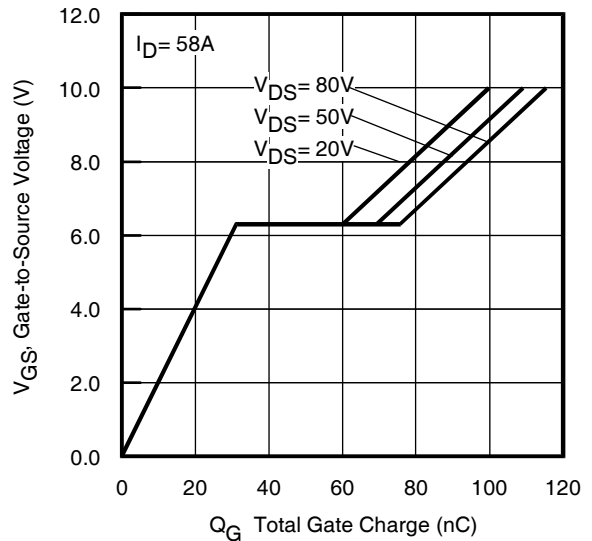

Fig 6. Typical Gate Charge vs. Gate-to-Source Voltage

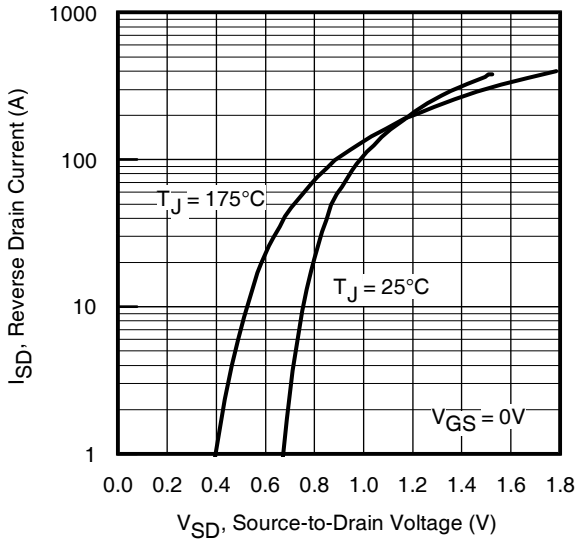

Fig 7. Typical Source-Drain Diode Forward Voltage

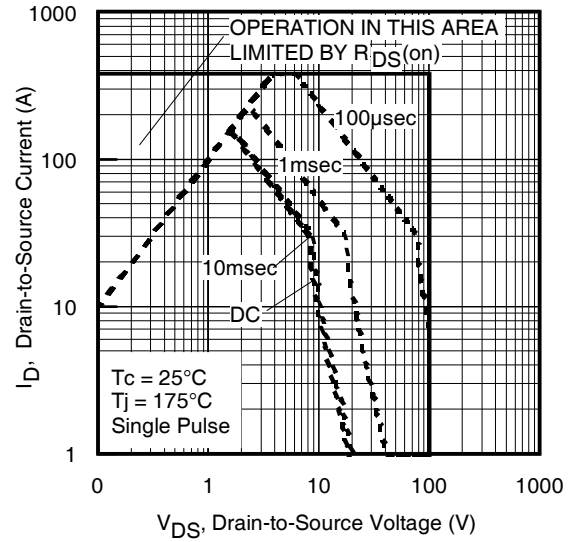

Fig 8. Maximum Safe Operating Area

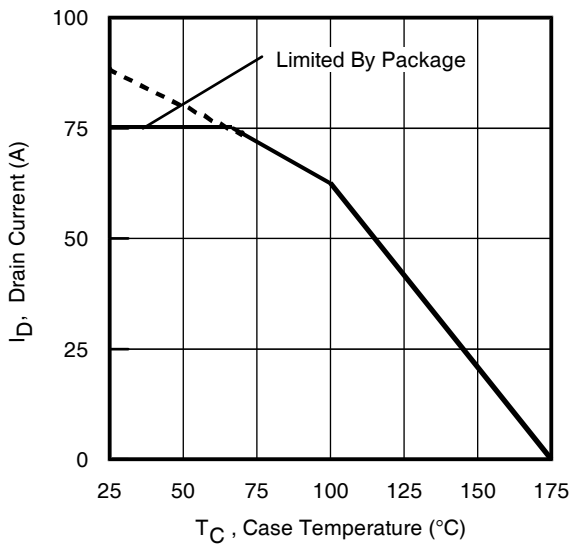

Fig 9. Maximum Drain Current vs. Case Temperature

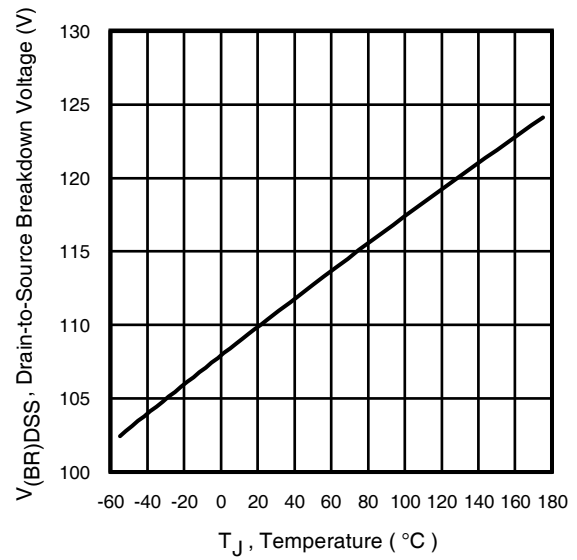

Fig 10. Drain-to-Source Breakdown Voltage

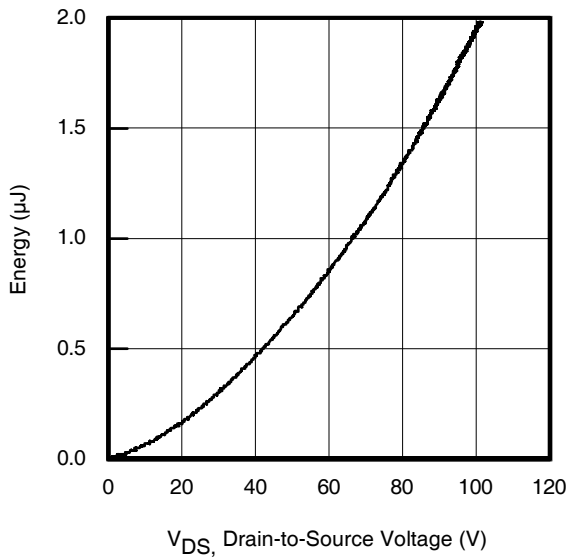

Fig 11. Typical C_{OSS} Stored Energy

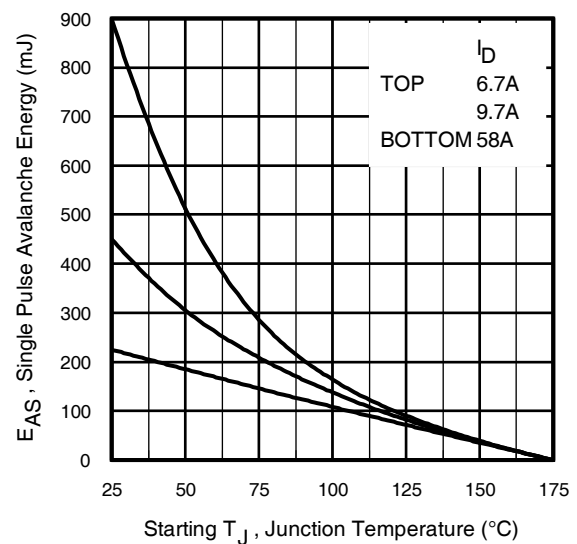

Fig 12. Maximum Avalanche Energy vs. Drain Current

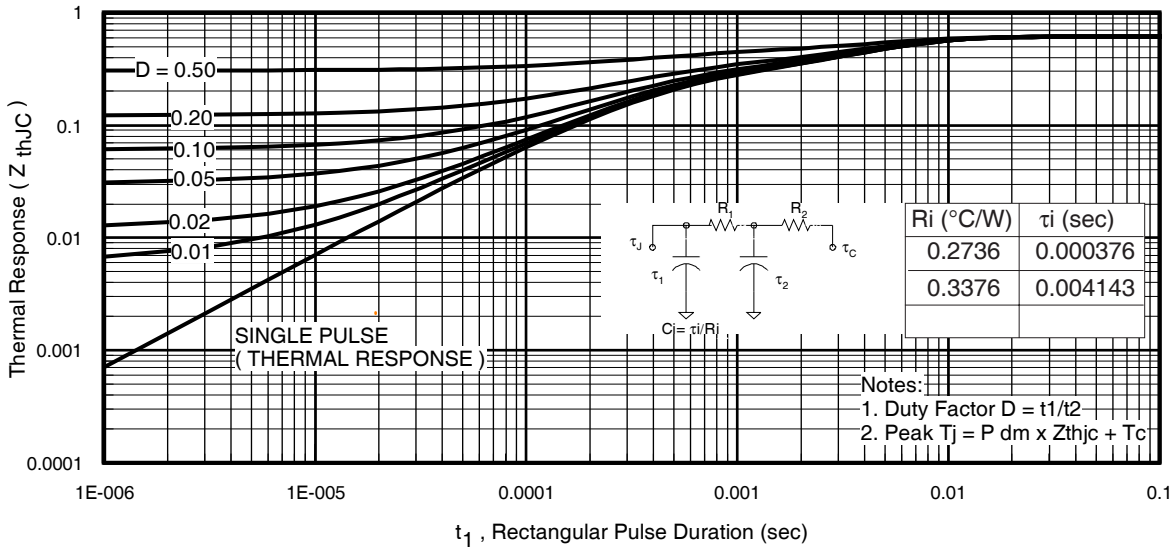

Fig 13. Maximum Effective Transient Thermal Impedance, Junction-to-Case

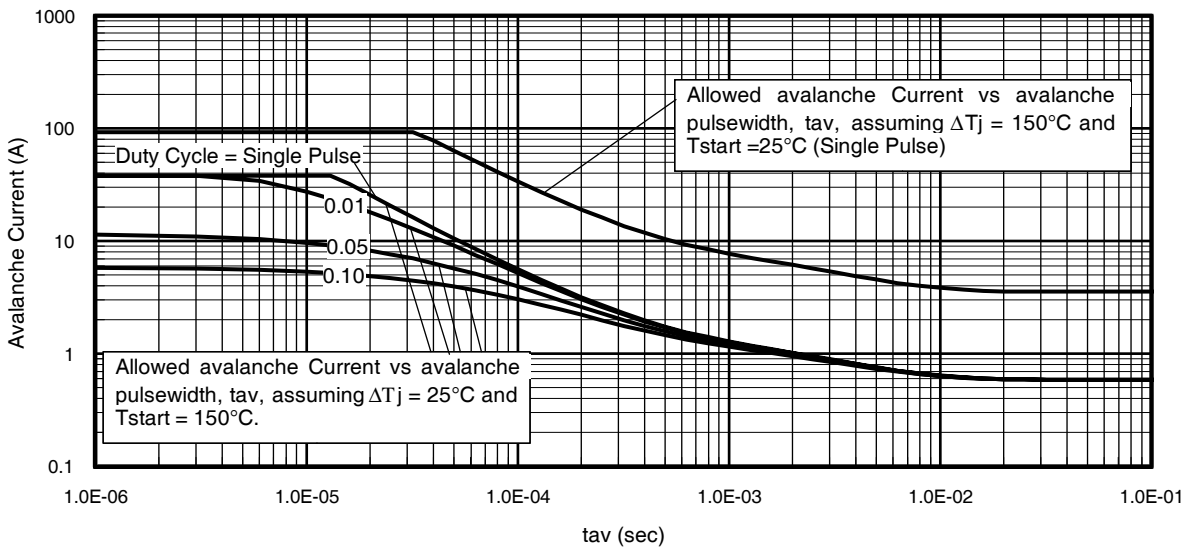

Fig 14. Typical Avalanche Current vs. Pulsewidth

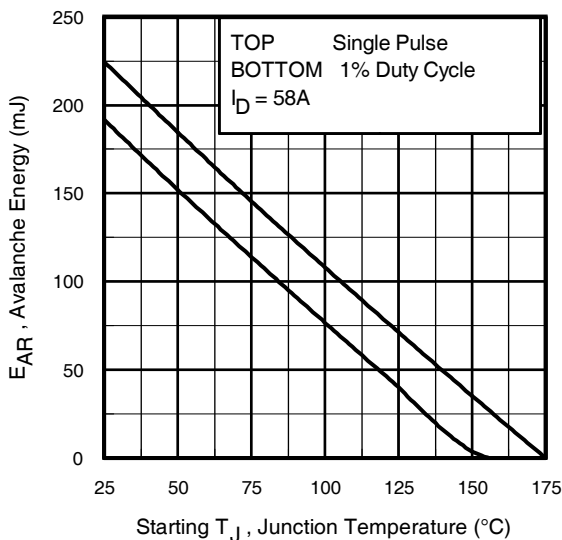

Fig 15. Maximum Avalanche Energy vs. Temperature

Notes on Repetitive Avalanche Curves, Figures 14, 15:
(For further info, see AN-1005 at www.irf.com)

1. Avalanche failures assumption: Purely a thermal phenomenon and failure occurs at a temperature far in excess of T_{jmax} . This is validated for every part type.
2. Safe operation in Avalanche is allowed as long as neither T_{jmax} nor $I_{av(max)}$ is exceeded.
3. Equation below based on circuit and waveforms shown in Figures 16a, 16b.
4. $P_{D(ave)}$ = Average power dissipation per single avalanche pulse.
5. BV = Rated breakdown voltage (1.3 factor accounts for voltage increase during avalanche).
6. I_{av} = Allowable avalanche current.
7. ΔT = Allowable rise in junction temperature, not to exceed T_{jmax} (assumed as 25°C in Figure 14, 15).
 t_{av} = Average time in avalanche.
 D = Duty cycle in avalanche = $t_{av} \cdot f$
 $Z_{thJC}(D, t_{av})$ = Transient thermal resistance, see Figures 13)

$$P_{D(ave)} = 1/2 (1.3 \cdot BV \cdot I_{av}) = \Delta T / Z_{thJC}$$

$$I_{av} = 2\Delta T / [1.3 \cdot BV \cdot Z_{thJC}]$$

$$E_{AS(AR)} = P_{D(ave)} \cdot t_{av}$$

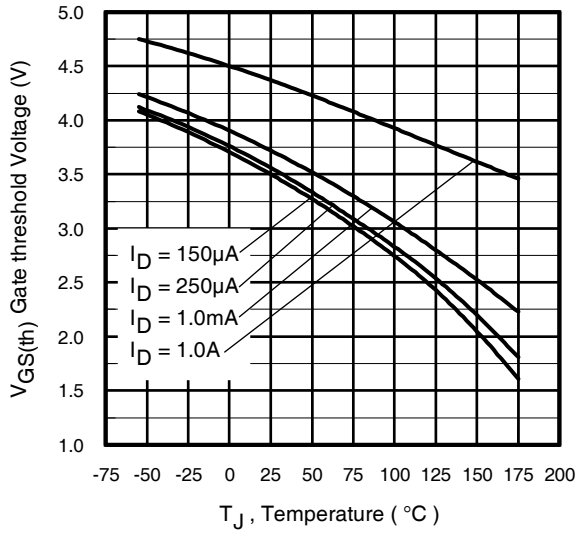

Fig 16. Threshold Voltage vs. Temperature

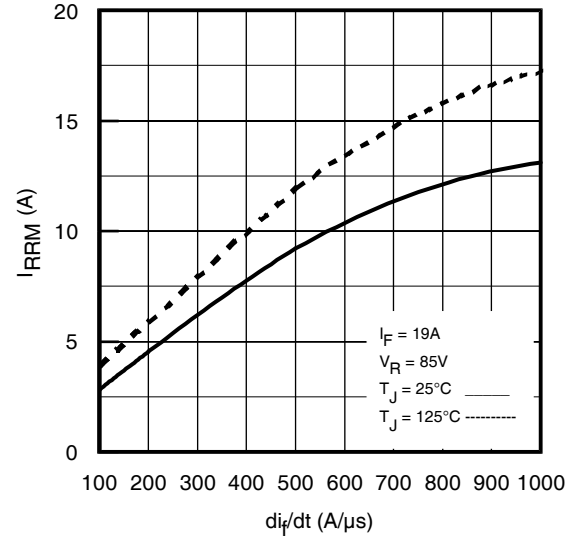

Fig. 17 - Typical Recovery Current vs. di_T/dt

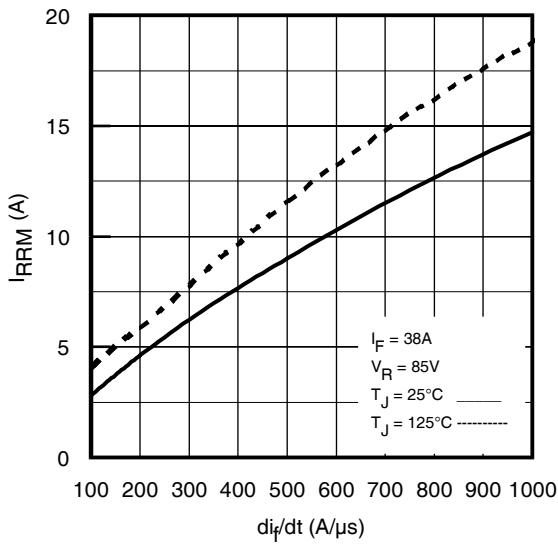

Fig. 18 - Typical Recovery Current vs. di_T/dt

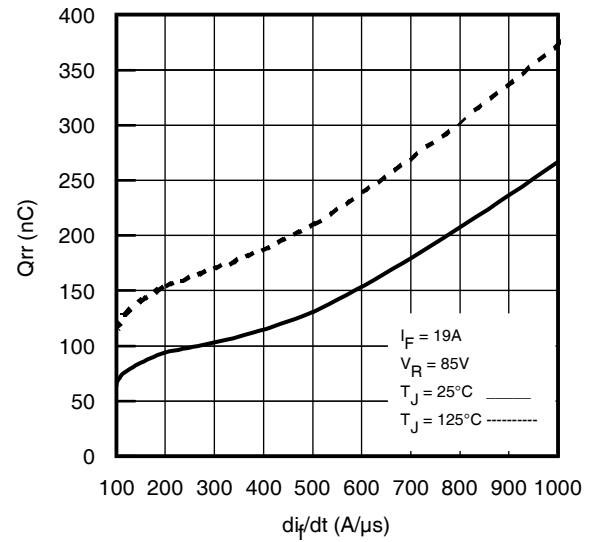

Fig. 19 - Typical Stored Charge vs. di_T/dt

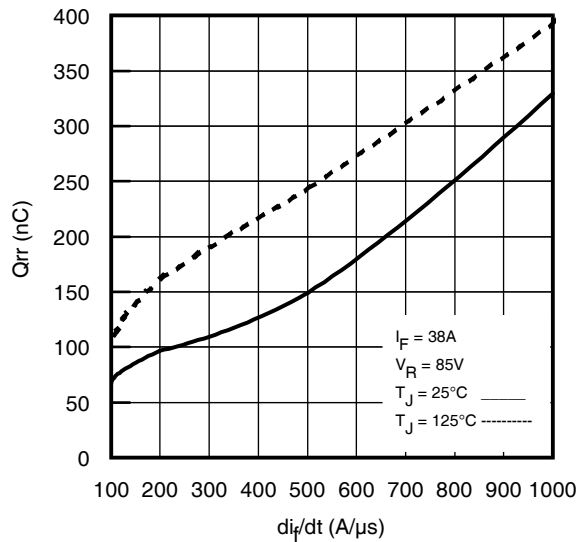
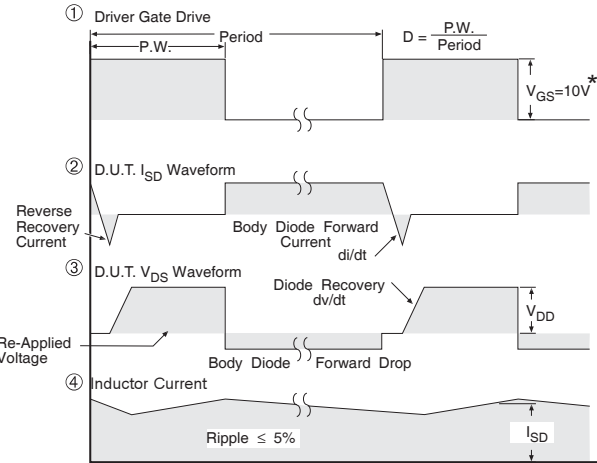
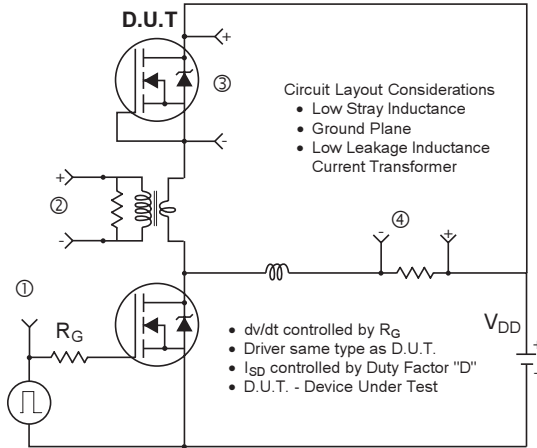

Fig. 20 - Typical Stored Charge vs. di_T/dt



* $V_{GS} = 5V$ for Logic Level Devices

Fig 20. Peak Diode Recovery dv/dt Test Circuit for N-Channel HEXFET[®] Power MOSFETs

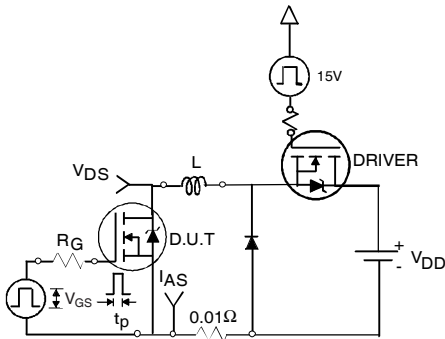

Fig 21a. Unclamped Inductive Test Circuit

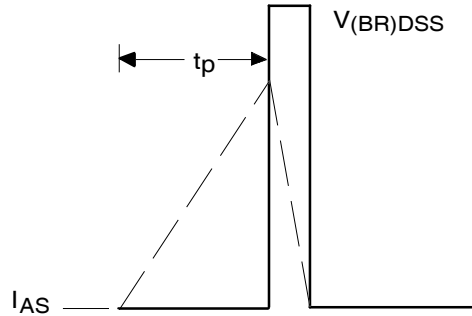

Fig 21b. Unclamped Inductive Waveforms

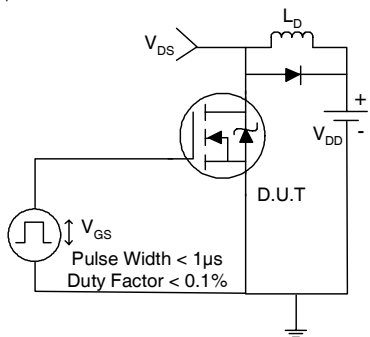

Fig 22a. Switching Time Test Circuit

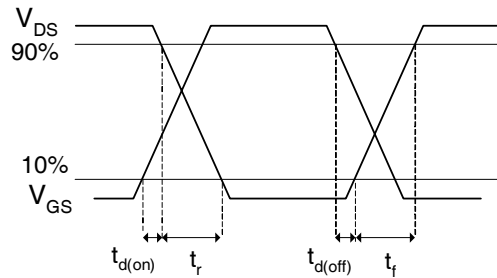

Fig 22b. Switching Time Waveforms

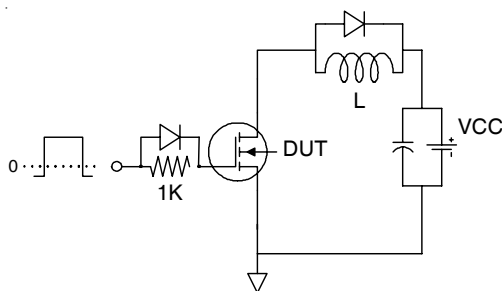

Fig 23a. Gate Charge Test Circuit

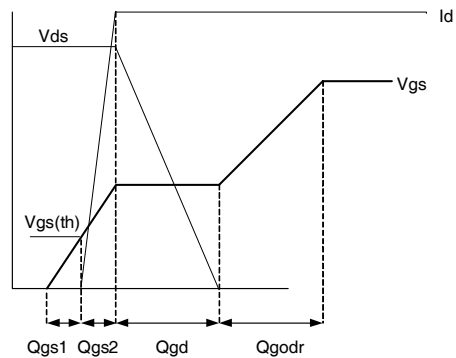
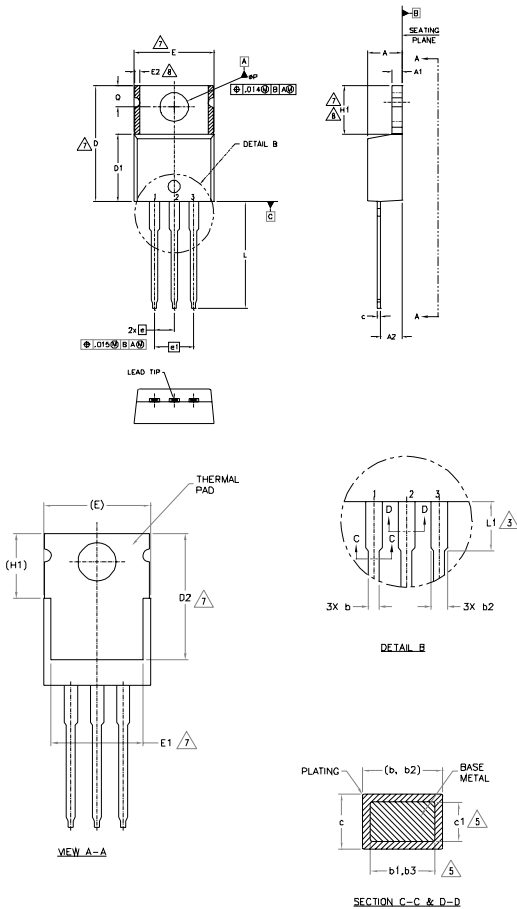

Fig 23b. Gate Charge Waveform

TO-220AB Package Outline

Dimensions are shown in millimeters (inches)



- NOTES:
- 1.- DIMENSIONING AND TOLERANCING AS PER ASME Y14.5 M- 1994.
 - 2.- DIMENSIONS ARE SHOWN IN INCHES [MILLIMETERS].
 - 3.- LEAD DIMENSION AND FINISH UNCONTROLLED IN L1.
 - 4.- DIMENSION D, D1 & E DO NOT INCLUDE MOLD FLASH. MOLD FLASH SHALL NOT EXCEED .005" (0.127) PER SIDE. THESE DIMENSIONS ARE MEASURED AT THE OUTERMOST EXTREMES OF THE PLASTIC BODY.
 - 5.- DIMENSION b1, b3 & c1 APPLY TO BASE METAL ONLY.
 - 6.- CONTROLLING DIMENSION : INCHES.
 - 7.- THERMAL PAD CONTOUR OPTIONAL WITHIN DIMENSIONS E,H1,D2 & E1
 - 8.- DIMENSION E2 X H1 DEFINE A ZONE WHERE STAMPING AND SINGULATION IRREGULARITIES ARE ALLOWED.
 - 9.- OUTLINE CONFORMS TO JEDEC TO-220, EXCEPT A2 (max.) AND D2 (min.) WHERE DIMENSIONS ARE DERIVED FROM THE ACTUAL PACKAGE OUTLINE.

SYMBOL	DIMENSIONS				NOTES
	MILLIMETERS		INCHES		
	MIN.	MAX.	MIN.	MAX.	
A	3.56	4.83	.140	.190	
A1	0.51	1.40	.020	.055	
A2	2.03	2.92	.080	.115	
b	0.38	1.01	.015	.040	5
b1	0.38	0.97	.015	.038	5
b2	1.14	1.78	.045	.070	
b3	1.14	1.73	.045	.068	
c	0.36	0.61	.014	.024	
c1	0.36	0.56	.014	.022	5
D	14.22	16.51	.560	.650	4
D1	8.38	9.02	.330	.355	
D2	11.68	12.88	.460	.507	7
E	9.65	10.67	.380	.420	4,7
E1	6.86	8.89	.270	.350	7
E2	-	0.76	-	.030	8
e	2.54 BSC		.100 BSC		
e1	5.08 BSC		.200 BSC		
H1	5.84	6.86	.230	.270	7,8
L	12.70	14.73	.500	.580	
L1	3.56	4.06	.140	.160	3
ØP	3.54	4.08	.139	.161	
Q	2.54	3.42	.100	.135	

LEAD ASSIGNMENTS

- HEXEE
1- GATE
2- DRAIN
3- SOURCE

- ISO 18. CoPACK
1- GATE
2- COLLECTOR
3- EMITTER

- DIODES
1- ANODE
2- CATHODE
3- ANODE

TO-220AB Part Marking Information

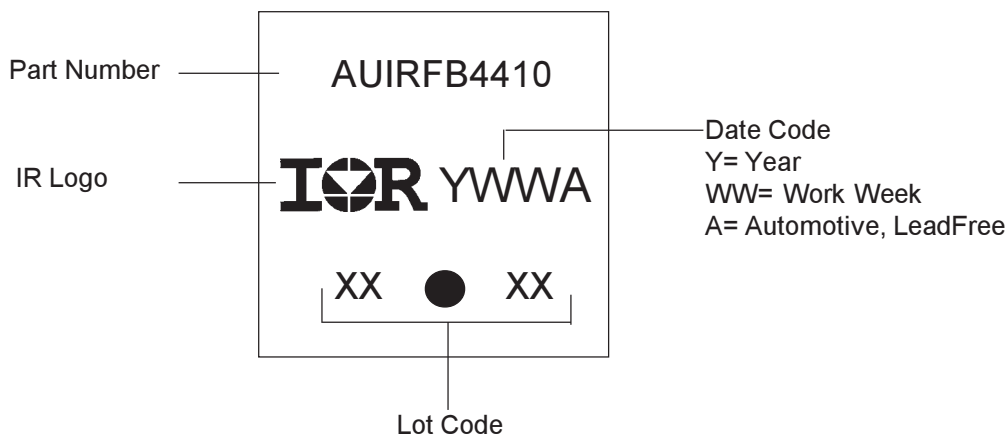

TO-220AB packages are not recommended for Surface Mount Application.

Note: For the most current drawing please refer to IR website at <http://www.irf.com/package/>

Ordering Information

Base part number	Package Type	Standard Pack		Complete Part Number
		Form	Quantity	
AUIRFB4410	TO-220	Tube	50	AUIRFB4410

IMPORTANT NOTICE

Unless specifically designated for the automotive market, International Rectifier Corporation and its subsidiaries (IR) reserve the right to make corrections, modifications, enhancements, improvements, and other changes to its products and services at any time and to discontinue any product or services without notice. Part numbers designated with the "AU" prefix follow automotive industry and / or customer specific requirements with regards to product discontinuance and process change notification. All products are sold subject to IR's terms and conditions of sale supplied at the time of order acknowledgment.

IR warrants performance of its hardware products to the specifications applicable at the time of sale in accordance with IR's standard warranty. Testing and other quality control techniques are used to the extent IR deems necessary to support this warranty. Except where mandated by government requirements, testing of all parameters of each product is not necessarily performed.

IR assumes no liability for applications assistance or customer product design. Customers are responsible for their products and applications using IR components. To minimize the risks with customer products and applications, customers should provide adequate design and operating safeguards.

Reproduction of IR information in IR data books or data sheets is permissible only if reproduction is without alteration and is accompanied by all associated warranties, conditions, limitations, and notices. Reproduction of this information with alterations is an unfair and deceptive business practice. IR is not responsible or liable for such altered documentation. Information of third parties may be subject to additional restrictions. Resale of IR products or serviced with statements different from or beyond the parameters stated by IR for that product or service voids all express and any implied warranties for the associated IR product or service and is an unfair and deceptive business practice. IR is not responsible or liable for any such statements.

IR products are not designed, intended, or authorized for use as components in systems intended for surgical implant into the body, or in other applications intended to support or sustain life, or in any other application in which the failure of the IR product could create a situation where personal injury or death may occur. Should Buyer purchase or use IR products for any such unintended or unauthorized application, Buyer shall indemnify and hold International Rectifier and its officers, employees, subsidiaries, affiliates, and distributors harmless against all claims, costs, damages, and expenses, and reasonable attorney fees arising out of, directly or indirectly, any claim of personal injury or death associated with such unintended or unauthorized use, even if such claim alleges that IR was negligent regarding the design or manufacture of the product.

IR products are neither designed nor intended for use in military/aerospace applications or environments unless the IR products are specifically designated by IR as military-grade or "enhanced plastic." Only products designated by IR as military-grade meet military specifications. Buyers acknowledge and agree that any such use of IR products which IR has not designated as military-grade is solely at the Buyer's risk, and that they are solely responsible for compliance with all legal and regulatory requirements in connection with such use.

IR products are neither designed nor intended for use in automotive applications or environments unless the specific IR products are designated by IR as compliant with ISO/TS 16949 requirements and bear a part number including the designation "AU". Buyers acknowledge and agree that, if they use any non-designated products in automotive applications, IR will not be responsible for any failure to meet such requirements.

For technical support, please contact IR's Technical Assistance Center
<http://www.irf.com/technical-info/>

WORLD HEADQUARTERS:
233 Kansas St., El Segundo, California 90245
Tel: (310) 252-7105