

APPLICABLE STANDARD		USB3.0 SPECIFICATION AND MICRO-USB CABLE AND CONNECTORS SPECIFICATION.				
RATING	OPERATING TEMPERATURE RANGE	-30°C TO +85°C		STORAGE TEMPERATURE RANGE	-30°C TO +60°C	
	VOLTAGE	30V AC		OPERATING HUMIDITY RANGE	- % TO - %	
	CURRENT	SIGNAL ONLY	1 A / pin		APPLICABLE CABLE OUTER DIAMETER OF CABLE : φ 3.3	
		POWER APPLY	1.8 A / pin(PIN No.1, No.5)			
	0.5 A / pin(PIN No.2-No.4)					
SPECIFICATIONS						
ITEM	TEST METHOD			REQUIREMENTS	QT	AT
CONSTRUCTION						
GENERAL EXAMINATION	VISUALLY AND BY MEASURING INSTRUMENT.			ACCORDING TO DRAWING.	X	X
MARKING	CONFIRMED VISUALLY.				X	X
ELECTRICAL CHARACTERISTICS						
CONTACT RESISTANCE	100 mA (DC OR 1000 Hz).			30 mΩ MAX.	X	X
INSULATION RESISTANCE	500 V DC.			1000 MΩ MIN.	X	X
VOLTAGE PROOF	100 V AC FOR 1 min.			NO FLASHOVER OR BREAKDOWN.	X	X
CAPACITANCE	MEASURE ADJACENT TWO CONTACTS AT 1000±10 Hz AC VOLTAGE.			2 pF MAX.	X	-
MECHANICAL CHARACTERISTICS						
INSERTION AND WITHDRAWAL FORCES	A MAXIMUM RATE OF 12.5 mm/min MEASURED BY APPLICABLE CONNECTOR.			INSERTION FORCE 35 N MAX. WITHDRAWAL FORCE 8 N MIN.	X	-
MECHANICAL OPERATION	10000 TIMES INSERTIONS AND EXTRACTATIONS. MATING SPEED - MECHANICALLY OPERATED : 500 CYCLES / h. or - MANUALLY OPERATED : 200 CYCLES / h.			1) CONTACT RESISTANCE: NO INCREASE OF MORE THAN 10 mΩ FROM INITIAL VALUE. 2) INSERTION FORCE 35 N MAX. WITHDRAWAL FORCE 8 N MIN 3) NO DAMAGE, CRACK AND LOOSENESS OF PARTS.	X	-
VIBRATION	FREQUENCY 10 TO 55 Hz SINGLE AMPLITUDE 0.75 mm, AT 2h FOR 3 AXIAL DIRECTIONS, TOTAL 6h.			1) NO ELECTRICAL DISCONTINUITY OF 1μs. 2) NO DAMAGE, CRACK AND LOOSENESS OF PARTS.	X	-
RANDOM VIBRATION	FREQUENCY 50 TO 2000 Hz AT 15 min FOR 3 AXIAL DIRECTIONS.				X	-
SHOCK	490 m/s ² DIRECTIONS OF PULSE 11 ms AT 3 TIMES FOR 6 DIRECTIONS, TOTAL 18 TIMES.				X	-
ENVIRONMENTAL CHARACTERISTICS						
THERMAL SHOCK	TEMP -55 → +15 TO +35 → +85 → +15 TO +35 °C TIME 30 → 2 TO 3 → 30 → 2 TO 3 min. UNDER 10 CYCLES. (MATING APPLICABLE CONNECTOR)			1) CONTACT RESISTANCE: 70 mΩ MAX. 2) INSULATION RESISTANCE: 100 MΩ MIN. 3) NO DAMAGE, CRACK AND LOOSENESS OF PARTS.	X	-
HUMIDITY LIFE	TEMPERATURE -10~65 °C, HUMIDITY 90 TO 98 %, UNDER 7 CYCLES (168 h) (MATING APPLICABLE CONNECTOR)			NO DAMAGE, CRACK AND LOOSENESS OF PARTS.	X	-
DRY HEAT	EXPOSED AT 85 ± 2 °C, 96 h. (MATING APPLICABLE CONNECTOR)			NO DAMAGE, CRACK AND LOOSENESS OF PARTS.	X	-
COLD	EXPOSED AT -40 ± 2 °C, 96 h. (MATING APPLICABLE CONNECTOR)			NO DAMAGE, CRACK AND LOOSENESS OF PARTS.	X	-
CORROSION SALT MIST	EXPOSED IN 5 % SALT WATER, 35 °C, FOR 48h. (LEFT UNDER UNMATED CONDITION)			NO HEAVY CORROSION.	X	-
	COUNT	DESCRIPTION OF REVISIONS		DESIGNED	CHECKED	DATE
△						
REMARK				APPROVED	AO. SUZUKI	09.06.16
HIROSE will not guarantee the performance on these specifications In case this product will be mated with the others which is not HIROSE's. Unless otherwise specified, refer to USB3.0 or EIA 364 .				CHECKED	KN. ICHIKAWA	09.06.16
				DESIGNED	TS. SAKAIZAWA	09.06.15
				DRAWN	TS. SAKAIZAWA	09.06.15
				Note QT:Qualification Test AT:Assurance Test X:Applicable Test		
HRS	SPECIFICATION SHEET			PART NO.	ZX360-B-10S-UNIT	
	HIROSE ELECTRIC CO., LTD.			CODE NO.	CL242-0501-4-00	△ 1/2

FORM HD0011-2-1

SPECIFICATIONS

ITEM	TEST METHOD	REQUIREMENTS	QT	AT
SOLDERABILITY	SOLDERING POINT IMMERSED IN SOLDER BATH OF 255 ± 5 °C, 5 sec. (USING TYPE R FRAX)	SOLDER SHALL COVER MINIMUM OF 95 % OF THE SURFACE BEING IMMERSED.	X	-
RESISTANCE TO SOLDERING HEAT	A PROFILE IS SHOWN IN FIG-1, UNDER 2 CYCLES.	NO DEFORMATION OR SIGNIFICANT LOOSENESS OF CONTACTS.	X	-

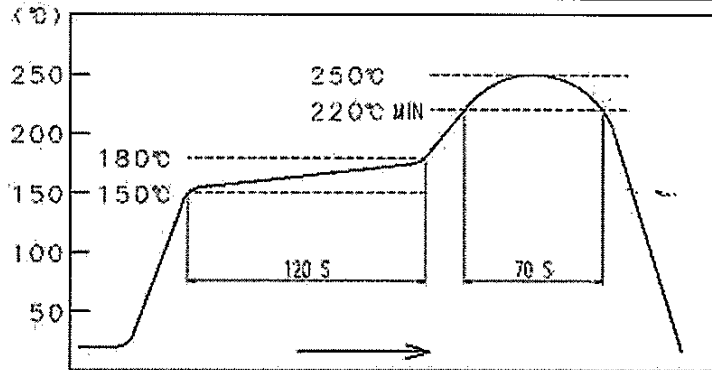

FIG - 1 RESISTANCE TO SOLDERING HEAT
(TEMPERATURE AT TOP SURFACE OF CONNECTOR)

RECOMMENDED PROFILE REFERS TO FIG - 2.
(TEMPERATURE AT SMT LEADS)

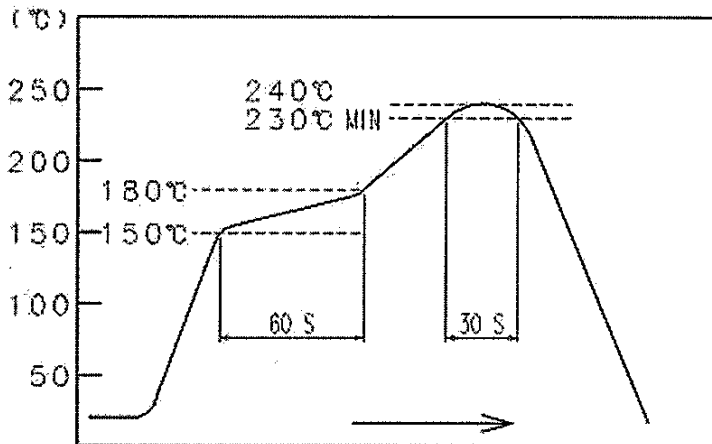

FIG - 2 RECOMMENDED REFLOW PROFILE TEMPERATURE

Note QT:Qualification Test AT:Assurance Test X:Applicable Test	DRAWING NO.	ELC4-127029-00		
HRS	SPECIFICATION SHEET	PART NO.	ZX360-B-10S-UNIT	
	HIROSE ELECTRIC CO., LTD.	CODE NO	CL242-0501-4-00	⚠ 2/2

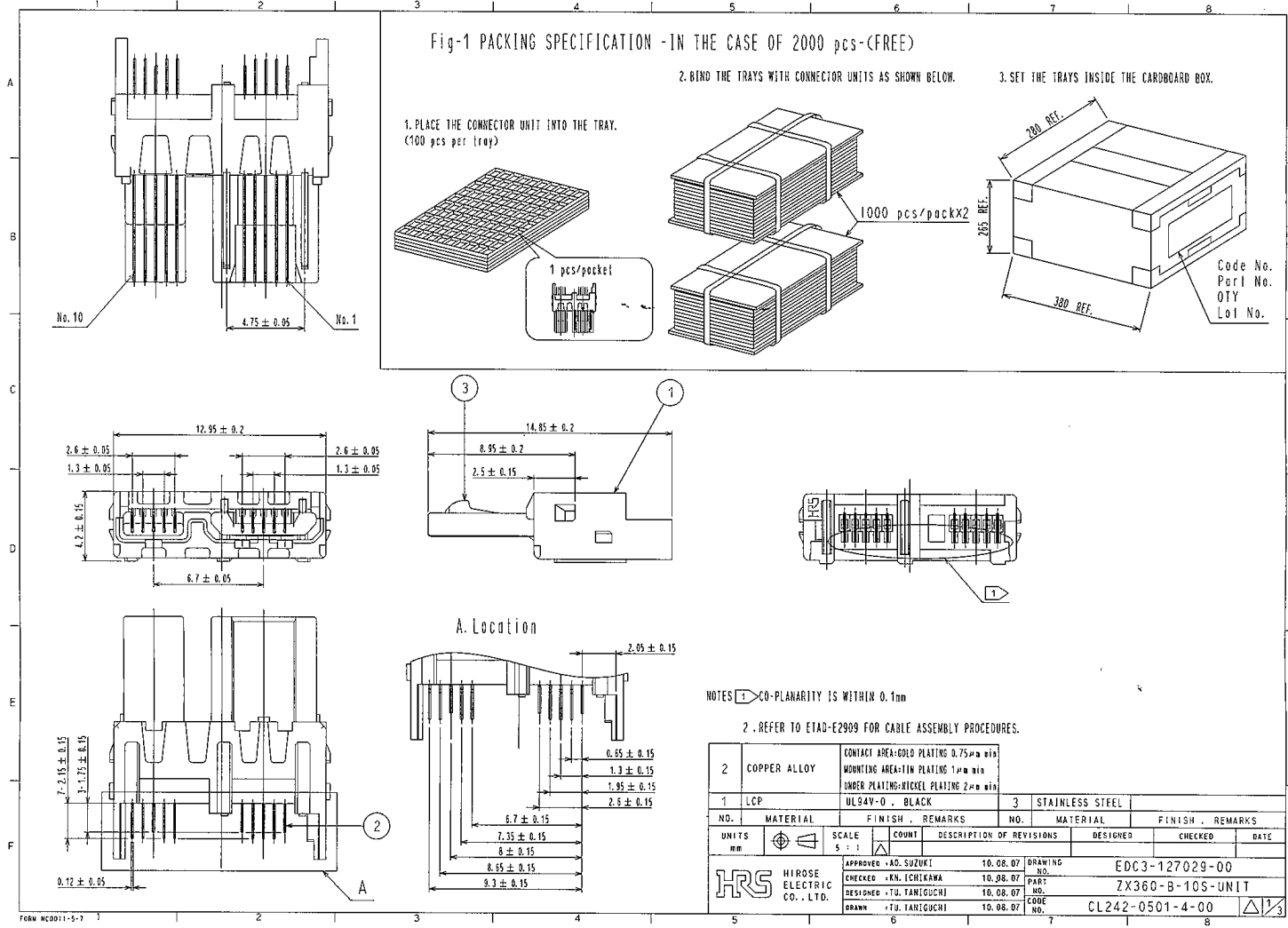
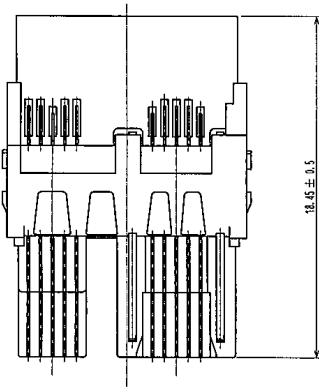
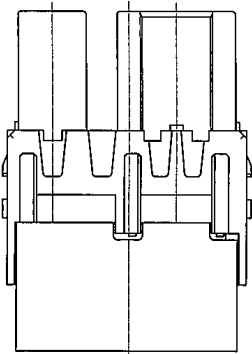
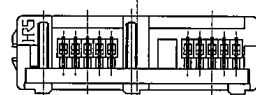
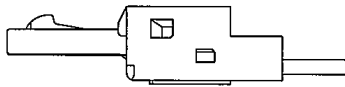
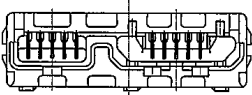
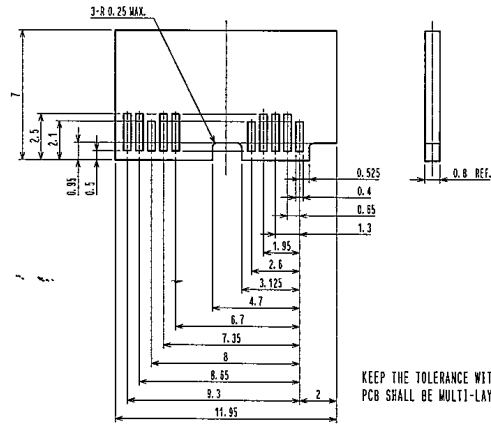

Fig-2. CONNECTOR MOUNTED ON PCB



PCB LAYOUT FOR REFERENCE



HRS	DRAWING NO.	EDC3-127029-00	
	PART NO.	ZX360-B-10S-UNIT	
	CODE	CL242-0501-4-00	
	NO.		

Fig-3 SHIELDING-PLATE ASSEMBLY

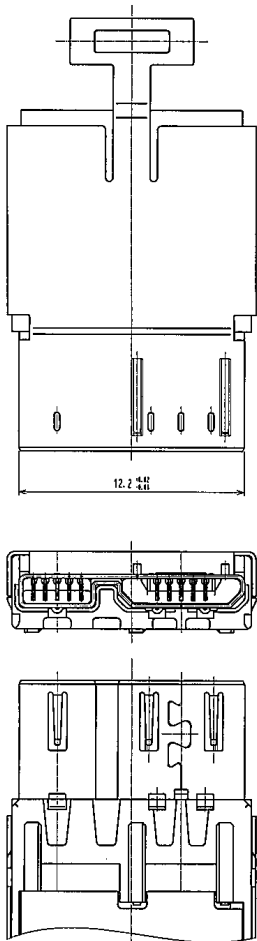

OVER-MOLDING (REFERENCE) (FREE)

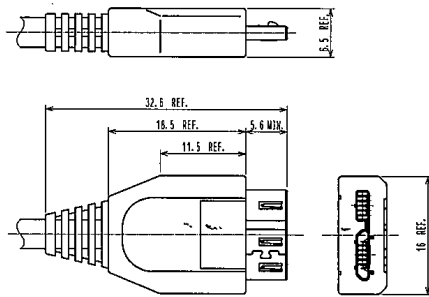

ZX360-B-SLDA(SOLD SEPARATELY)

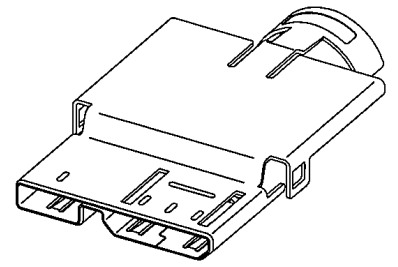
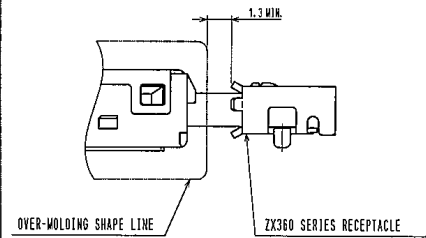
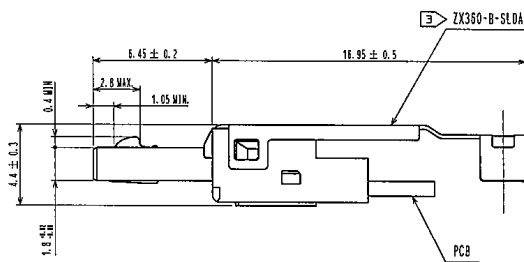

Fig-4 MATED WITH CORRESPONDING PLUG



NOTES: THIS COMPONENT IS ALWAYS USED WITH SEPARATELY AVAILABLE ZX360-B-SLDA

HRS	DRAWING NO.	EDC3-127029-00
	PART NO.	ZX360-B-10S-UNIT
	CODE NO.	CL242-0501-4-00
	NO.	3/3