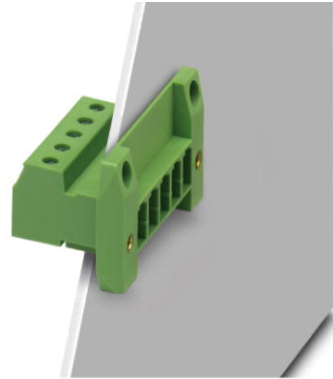

DFK-PC 4/ 6-GF-7,62

Order No.: 1840599

The figure shows a 5-pos. version of the product

<http://eshop.phoenixcontact.de/phoenix/treeViewClick.do?UID=1840599>

Plug component, Nominal current: 20 A, Rated voltage (III/2): 630 V,
Number of positions: 6, Pitch: 7.62 mm, Color: green, Metal surface:
Sn, Assembly: Direct mounting

Commercial data

GTIN (EAN)	
sales group	E513
Pack	50 pcs.
Customs tariff	85369010
Catalog page information	Page 372 (CC-2009)

Product notesWEEE/RoHS-compliant since:
01/01/2003

<http://www.download.phoenixcontact.com>
Please note that the data given here has been taken from the online catalog. For comprehensive information and data, please refer to the user documentation. The General Terms and Conditions of Use apply to Internet downloads.

Technical data**Dimensions / positions**

Pitch	7.62 mm
Dimension a	38.1 mm
Number of positions	6
Screw thread	M3

Tightening torque, min	0.5 Nm
Tightening torque max	0.6 Nm

Technical data

Range of articles	DFK-PC 4/...-GF
Insulating material group	I
Rated surge voltage (III/3)	6 kV
Rated surge voltage (III/2)	6 kV
Rated surge voltage (II/2)	6 kV
Rated voltage (III/2)	630 V
Rated voltage (II/2)	1000 V
Connection in acc. with standard	EN-VDE
Nominal current I_N	20 A
Nominal voltage U_N	400 V
Nominal cross section	4 mm ²
Maximum load current	20 A
Insulating material	PA
Inflammability class acc. to UL 94	V0
Stripping length	7 mm
Internal cylindrical gage	A4

Connection data

Conductor cross section solid min.	0.2 mm ²
Conductor cross section solid max.	4 mm ²
Conductor cross section stranded min.	0.2 mm ²
Conductor cross section stranded max.	4 mm ²
Conductor cross section stranded, with ferrule without plastic sleeve min.	0.25 mm ²
Conductor cross section stranded, with ferrule without plastic sleeve max.	4 mm ²
Conductor cross section stranded, with ferrule with plastic sleeve min.	0.25 mm ²
Conductor cross section stranded, with ferrule with plastic sleeve max.	4 mm ²
Conductor cross section AWG/kcmil min.	24
Conductor cross section AWG/kcmil max	10
2 conductors with same cross section, solid min.	0.2 mm ²
2 conductors with same cross section, solid max.	2.5 mm ²

2 conductors with same cross section, stranded min.	0.2 mm ²
2 conductors with same cross section, stranded max.	2.5 mm ²
2 conductors with same cross section, stranded, ferrules without plastic sleeve, min.	0.2 mm ²
2 conductors with same cross section, stranded, ferrules without plastic sleeve, max.	1.5 mm ²
2 conductors with same cross section, stranded, TWIN ferrules with plastic sleeve, min.	0.5 mm ²
2 conductors with same cross section, stranded, TWIN ferrules with plastic sleeve, max.	2.5 mm ²

Certificates / Approvals



Certification

CSA, CUL, DNV, GL, GOST, LR, UL

Accessories

Item	Designation	Description
Assembly		
0708263	DFK-MSTB-SS	Screw set, for securing the header to the device wall, consists of an M3 x 10 screw, with a spring washer and a nut
Marking		
0804549	SK 7,62/3,8:FORTL.ZAHLEN	Marker card, printed horizontally, self-adhesive, 10-section marker strip, 12 identical decades marked 1-10, 11-20 etc. up to 91-99, sufficient for 120 terminal blocks
Plug/Adapter		
1600027	CP-HCC 4	Coding profile, Color: red
Tools		
1205053	SZS 0,6X3,5	Actuation tool, for ST terminal blocks, insulated, also suitable for use as a bladed screwdriver, size: 0.6 x 3.5 x 100 mm, 2-component grip, with non-slip grip

Additional products

Item	Designation	Description
General		
1880119	PC 4 HV/ 6-STF-7,62	Plug component, Nominal current: 20 A, Rated voltage (III/2): 1000 V, Number of positions: 6, Pitch: 7.62 mm, Color: green, Metal surface: Sn
1828281	PC 4/ 6-STF-7,62	Plug component, Nominal current: 20 A, Rated voltage (III/2): 630 V, Number of positions: 6, Pitch: 7.62 mm, Color: green, Metal surface: Sn

Diagrams/Drawings

Diagram

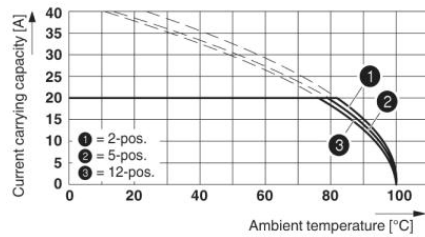

Derating curve for: PC 4/...-ST-7,62 with DFK-PC 4/...-GF-7,62

Dimensioned drawing

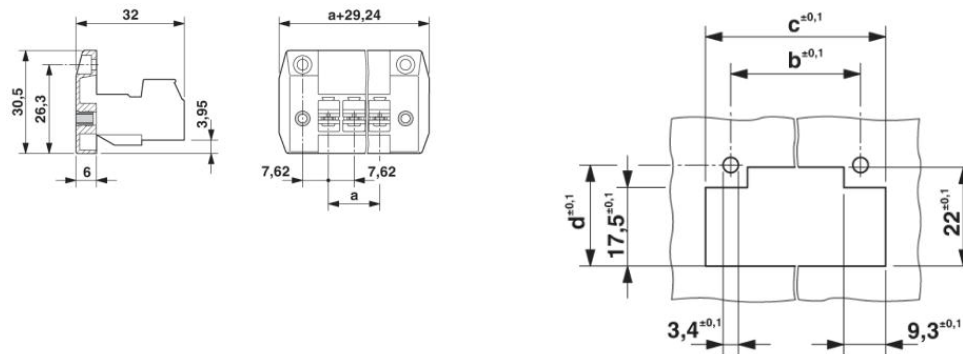

Address

PHOENIX CONTACT Deutschland GmbH
Flachsmarktstr. 8
32825 Blomberg, Germany
Phone +49 5235 3 12000
Fax +49 5235 3 41200
<http://www.phoenixcontact.de>



© 2010 Phoenix Contact
Technical modifications reserved;