

EMSTB 2,5/ 4-GF-5,08

Order No.: 1899634

The figure shows a 10-position version of the product

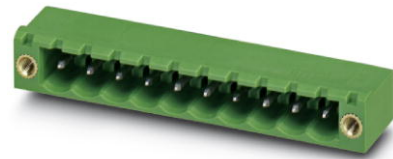

<http://eshop.phoenixcontact.de/phoenix/treeViewClick.do?UID=1899634>

Header, Nominal current: 12 A, Rated voltage (III/2): 320 V, Number of positions: 4, Pitch: 5.08 mm, Color: green, Metal surface: Sn, Assembly: Press-in

Commercial data	
GTIN (EAN)	
Note	Made-to-order
sales group	E115
Pack	50 pcs.
Customs tariff	85366990
Catalog page information	Page 247 (CC-2009)

Product notes

WEEE/RoHS-compliant since:
01/01/2003



<http://www.download.phoenixcontact.com>
Please note that the data given here has been taken from the online catalog. For comprehensive information and data, please refer to the user documentation. The General Terms and Conditions of Use apply to Internet downloads.

Technical data	
Dimensions / positions	
Length	12 mm
Pitch	5.08 mm
Dimension a	15.24 mm
Number of positions	4

Pin dimensions	1,7 mm
Hole diameter	1.75 mm

Technical data

Range of articles	EMSTB 2,5/...-GF
Insulating material group	IIIa
Rated surge voltage (III/3)	4 kV
Rated surge voltage (III/2)	4 kV
Rated surge voltage (II/2)	4 kV
Rated voltage (III/2)	320 V
Rated voltage (II/2)	400 V
Connection in acc. with standard	EN-VDE
Nominal current I_N	12 A
Nominal voltage U_N	250 V
Maximum load current	12 A
Insulating material	PBT
Inflammability class acc. to UL 94	V0
Nominal voltage, UL/CUL Use Group B	250 V
Nominal current, UL/CUL Use Group B	12 A
Nominal voltage, UL/CUL Use Group D	300 V
Nominal current, UL/CUL Use Group D	10 A

Certificates / Approvals



Certification

CB, CUL, GOST, UL, VDE-PZI

Accessories

Item	Designation	Description
Assembly		
1877203	EMSTB 2,5-SH	Stamp holder, for upper and lower stamp
1877216	EMSTBVA 2,5-SS-1-5,08	Stamp set, consisting of an upper and lower stamp, upper stamp: 2 to 16-pos., lower stamp: 2 to 24-pos., pitch: 5.08 mm

1877229	EMSTBVA 2,5-SS-2-5,08	Stamp set, consisting of an upper and lower stamp, upper stamp: 17 to 24-pos., lower stamp: 2 to 24-pos., pitch: 5.08 mm
1755477	MSTB-BL	Keying cap, for forming sections, plugs onto header pin, green insulating material

Marking

0804293	SK 5,08/3,8:FORTL.ZAHLEN	Marker card, printed horizontally, self-adhesive, 12 identical decades marked 1-10, 11-20 etc. up to 91-(99)100, sufficient for 120 terminal blocks
---------	--------------------------	---

Plug/Adapter

1734401	CR-MSTB	Coding section, inserted into the recess in the header or the inverted plug, red insulating material
---------	---------	--

Additional products

Item	Designation	Description
General		
1873223	FKC 2,5/ 4-STF-5,08	Plug component, Nominal current: 12 A, Rated voltage (III/2): 320 V, Number of positions: 4, Pitch: 5.08 mm, Color: green, Metal surface: Sn
1902327	FKCT 2,5/ 4-STF-5,08	Plug component, Nominal current: 12 A, Rated voltage (III/2): 320 V, Number of positions: 4, Pitch: 5.08 mm, Color: green, Metal surface: Sn
1874125	FKCVR 2,5/ 4-STF-5,08	Plug component, Nominal current: 12 A, Rated voltage (III/2): 320 V, Number of positions: 4, Pitch: 5.08 mm, Color: green, Metal surface: Sn
1873825	FKCVW 2,5/ 4-STF-5,08	Plug component, Nominal current: 12 A, Rated voltage (III/2): 320 V, Number of positions: 4, Pitch: 5.08 mm, Color: green, Metal surface: Sn
1777824	FRONT-MSTB 2,5/ 4-STF-5,08	Plug component, Nominal current: 12 A, Rated voltage (III/2): 320 V, Number of positions: 4, Pitch: 5.08 mm, Color: green, Metal surface: Sn
1778001	MSTB 2,5/ 4-STF-5,08	Plug component, Nominal current: 12 A, Rated voltage (III/2): 320 V, Number of positions: 4, Pitch: 5.08 mm, Color: green, Metal surface: Sn
1809750	MSTBC 2,5/ 4-STZF-5,08	Plug component, Nominal current: 12 A, Rated voltage (III/2): 320 V, Number of positions: 4, Pitch: 5.08 mm, Color: green, Metal surface: Sn, Corresponding female crimp contacts with current [A] and conductor cross section range [mm ²] data: 10A/MSTBC-MT 0,5-1,0 (3190564); 10A/MSTBC-MT 0,5-1,0 BA (3190645); 12A/MSTBC-MT 1,5-2,5 (3190551); 12A/MSTBC-MT 1,5-2,5 BA (3190658). BA = Bandkontakte
1805327	MSTBT 2,5/ 4-STF-5,08	Plug component, Nominal current: 12 A, Rated voltage (III/2): 320 V, Number of positions: 4, Pitch: 5.08 mm, Color: green, Metal surface: Sn

1835119	MVSTBR 2,5/ 4-STF-5,08	Plug component, Nominal current: 12 A, Rated voltage (III/2): 320 V, Number of positions: 4, Pitch: 5.08 mm, Color: green, Metal surface: Sn
1834929	MVSTBW 2,5/ 4-STF-5,08	Plug component, Nominal current: 12 A, Rated voltage (III/2): 320 V, Number of positions: 4, Pitch: 5.08 mm, Color: green, Metal surface: Sn
1883378	QC 1/ 4-STF-5,08	Plug component, Nominal current: 10 A, Rated voltage (III/2): 630 V, Number of positions: 4, Pitch: 5.08 mm, Color: green, Metal surface: Sn
1853120	TMSTBP 2,5/ 4-STF-5,08	Plug component, Nominal current: 12 A, Rated voltage (III/2): 320 V, Number of positions: 4, Pitch: 5.08 mm, Color: green, Metal surface: Sn, The plug allows conductors to be looped through from module to module.

Diagrams/Drawings

Drilling plan/solder pad geometry

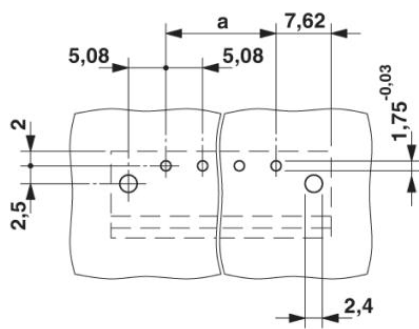

Bore hole in the basic material,
mostly epoxy glass fabric FR4 or EP-GC

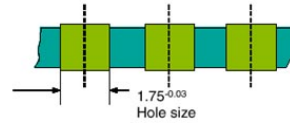

Bore hole with Cu ferrule

Bore hole with Cu ferrule

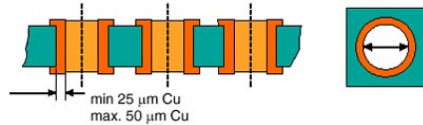

Plated-through bore hole with Sn/SnPb

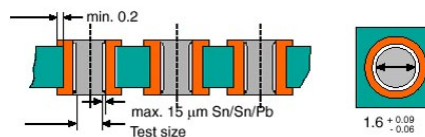

Dimensioned drawing

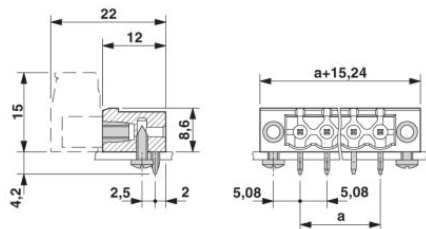

Address

PHOENIX CONTACT Deutschland GmbH
Flachsmarktstr. 8
32825 Blomberg, Germany
Phone +49 5235 3 12000
Fax +49 5235 3 41200
<http://www.phoenixcontact.de>



© 2010 Phoenix Contact
Technical modifications reserved;