

MATERIAL NO. ON STRIP	MATERIAL NO. LOOSE PIECE	CABLE SIZE	DIM. "A"	DIM. "B"	USE WITH HOUSING ASSY
1301960315	1301960313	2.5mm ² / 14AWG	3.58/.141	3.94/.155	1302440204
1301960314	1301960310	4.0-6.0mm ² / 12-10AWG	4.90/.193	5.51/.217	1302440202

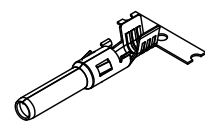

12-10 AWG (4.0-6.0mm²)
SCALE 2:1

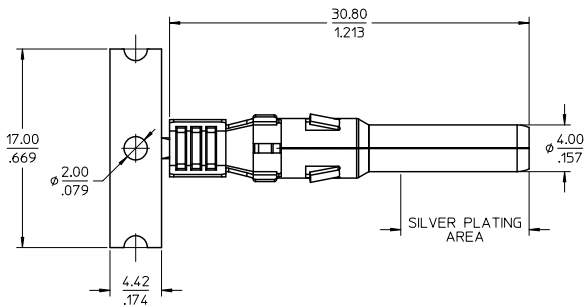
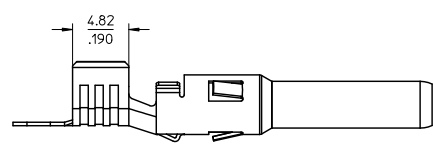
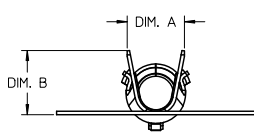

12-10 AWG (4.0-6.0mm²)

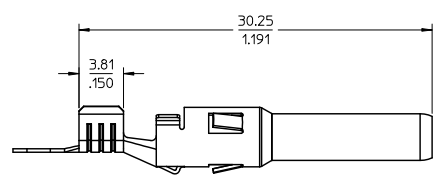
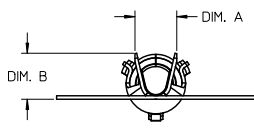

14 AWG (2.5mm²)
SAME AS 12-10 AWG
EXCEPT AS NOTED

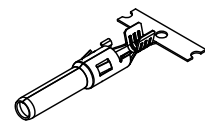

14 AWG (2.5mm²)
SCALE 2:1

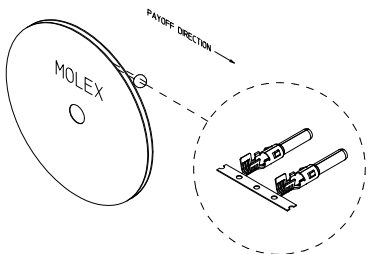

NOTES:

1. MATERIAL: COPPER ALLOY 0.30/.012 THK.
2. FINISH: 2.0METER/80INCH MIN. SELECTIVE SILVER OVER 1.27METER/50INCH MIN. NICKEL OVERALL.
3. TERMINAL FOR USE WITH 130244 SERIES PIN HOUSING ASSEMBLY. SEE CHART FOR APPLICABLE PART NUMBERS.
4. PRODUCT SPECIFICATION: PS-130244-001
5. STRIP TERMINALS ARE REELED AS SHOWN ABOVE ON XXX SIZE REELS. XXX PARTS PER REEL.
6. APPLICATION TOOLING AND CRIMP SPECIFICATIONS: CONSULT FACTORY.
7. PARTS ARE ROHS COMPLIANT.

PRELIMINARY EC NO: WNA2011-0195 2 DRAWN: CLYORK 2010/11/24 CHKD: DTITUS APPR: DTITUS 2011/01/14 REV:	QUALITY SYMBOLS ▽=0 ▽=0	GENERAL TOLERANCES (UNLESS SPECIFIED) mm INCH 4 PLACES ±.05 ±.0025 3 PLACES ±.025 ±.01 2 PLACES ±.05 ±.02 1 PLACE ±.05 ±.0025 ANGULAR ± 3°		DIMENSION STYLE MM/IN DRAWN BY: CLYORK DATE: 2010/04/15 CHECKED BY: DTITUS DATE: 2010/04/15 APPROVED BY: DTITUS DATE: 2010/05/07		SCALE 4:1	DESIGN UNITS METRIC	THIRD ANGLE PROJECTION
		DRAFT WHERE APPLICABLE MUST REMAIN WITHIN DIMENSIONS				MATERIAL NO. SEE CHART	DOCUMENT NO. SD-130196-001	TITLE PIN CONTACT, PV SOLAR 14 & 12-10 AWG
THIS DRAWING CONTAINS INFORMATION THAT IS PROPRIETARY TO MOLEX INCORPORATED AND SHOULD NOT BE USED WITHOUT WRITTEN PERMISSION								SHEET NO. 1 OF 1