

FEATURES

- RoHS compliant
- Compatible with leading chip sets
- 2kVrms isolation
- Industry-standard pinout
- Surface mount option
- UL 94 V-0 package materials
- Low profile
- Suitable for both 75 & 110Ω circuits
- Toroidal construction
- Compliant with AES/EBU standards
- Fully encapsulated

DESCRIPTION

The Digital Audio Range of transformers is designed to improve the balance of transmitter and receiver circuitry in hi-fi equipment, video games and other applications requiring high-performance digital audio transmission. Compliant with AES/EBU recommendations for the digital audio interface, offering optimised shunt capacitance between primary and secondary windings. Capable of operating over the audio data rate frequency range, providing isolation from 50-60Hz noise.



SELECTION GUIDE

Order Code	Turns Ratio	Primary Inductance	Max. Leakage Inductance (100kHz, 10mV)	Min. Volt-time Product, Et	Min. Return Loss (100kHz-3MHz)	Typ. Common Mode Rejection (100kHz, 110Ω)	Isolation (Flash tested for 1 second)
		mH	μH	Vμs	dB	dB	Vrms
DA101C	1:1	1.00 - 2.06	0.22	15	46.80	52.10	2000
DA102C	1:1	2.00 - 3.90	0.39	20	40.40	49.70	
DA103C	1:1	4.00 - 7.75	0.91	28	36.30	46.40	

ORDER CODE DETAILS

Order Code	Package Type	Packaging Type	Quantity
DAXXXC	6 Pin DIL	Tube	50
DAXXXMC	6 Pin SM	Tube	50
DAXXXMC-R	6 Pin SM	Tape & Reel	500

ABSOLUTE MAXIMUM RATINGS

Operating free air temperature range	0°C to 70°C
Storage temperature range	-40°C to 125°C

All specifications typical at $T_A = 25^\circ\text{C}$

TECHNICAL NOTES

ISOLATION VOLTAGE

'Hi Pot Test', 'Flash Tested', 'Withstand Voltage', 'Proof Voltage', 'Dielectric Withstand Voltage' & 'Isolation Test Voltage' are all terms that relate to the same thing, a test voltage, applied for a specified time, across a component designed to provide electrical isolation, to verify the integrity of that isolation.

All products in this series are 100% production tested at their stated isolation voltage.

A question commonly asked is, "What is the continuous voltage that can be applied across the part in normal operation?"

For a part holding no specific agency approvals both input and output should normally be maintained within SELV limits i.e. less than 42.4V peak, or 60VDC. The isolation test voltage represents a measure of immunity to transient voltages and the part should never be used as an element of a safety isolation system. The part could be expected to function correctly with several hundred volts offset applied continuously across the isolation barrier; but then the circuitry on both sides of the barrier must be regarded as operating at an unsafe voltage and further isolation/insulation systems must form a barrier between these circuits and any user-accessible circuitry according to safety standard requirements.

REPEATED HIGH-VOLTAGE ISOLATION TESTING

It is well known that repeated high-voltage isolation testing of a barrier component can actually degrade isolation capability, to a lesser or greater degree depending on materials, construction and environment. This series has toroidal isolation transformers, with no additional insulation between primary and secondary windings of enameled wire. While parts can be expected to withstand several times the stated test voltage, the isolation capability does depend on the wire insulation. Any material, including this enamel (typically polyurethane) is susceptible to eventual chemical degradation when subject to very high applied voltages thus implying that the number of tests should be strictly limited. We therefore strongly advise against repeated high voltage isolation testing, but if it is absolutely required, that the voltage be reduced by 20% from specified test voltage.

This consideration equally applies to agency recognized parts rated for better than functional isolation where the wire enamel insulation is always supplemented by a further insulation system of physical spacing or barriers.

PACKAGE SPECIFICATIONS

MECHANICAL DIMENSIONS

6 Pin DIL

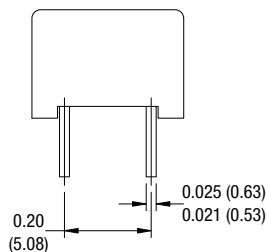
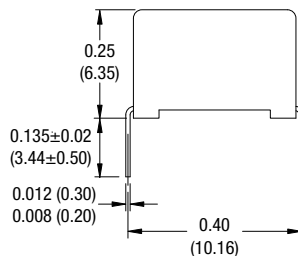
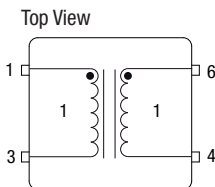
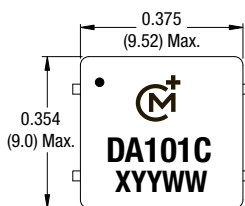

6 Pin SM

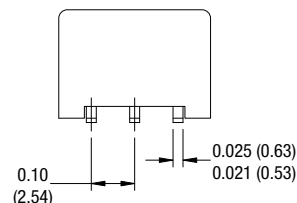
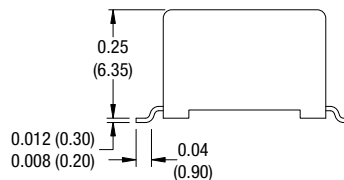
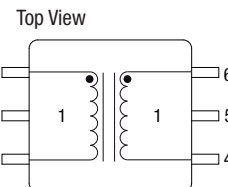
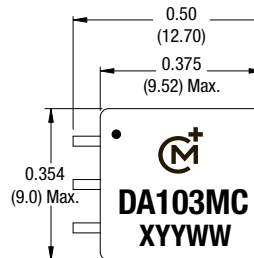

Unless otherwise stated all dimensions in inches (mm) ±0.01 (0.25).
All pins on a 0.1 (2.54) pitch and within ±0.01 (0.25) of true position.
Package Weight 0.93g Typ.

RECOMMENDED FOOTPRINT DETAILS

6 Pin DIL

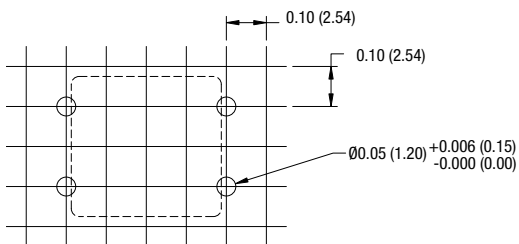

6 Pin SM

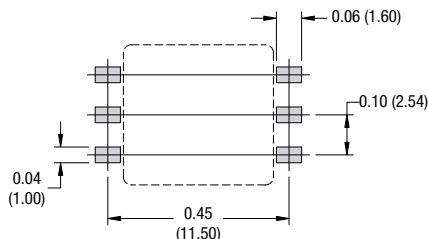

Unless otherwise stated all dimensions in inches (mm) ±0.01 (0.25). All pins on a 0.1 (2.54) pitch and within ±0.01 (0.25) of true position.

SOLDERING INFORMATION¹

Pin finish	Matte tin
Peak wave solder temperature	300°C for 10 seconds
Peak reflow temperature	220°C ²

1 For further information, please visit www.murata-ps.com/rohs
2 For high temperature reflow parts see DA100J series

TUBE OUTLINE DIMENSIONS

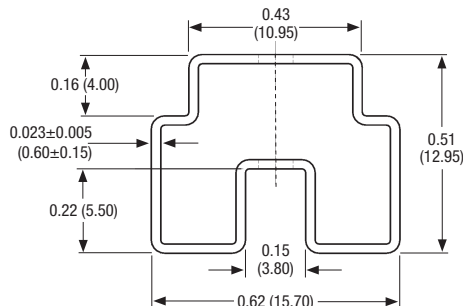

Unless otherwise stated all dimensions in inches (mm) ±0.01 (0.25).

Tube length: 18.3±0.08 (465±2).

Tube material: Antistatic coated clear pvc.

TAPE & REEL SPECIFICATIONS

REEL OUTLINE DIMENSIONS

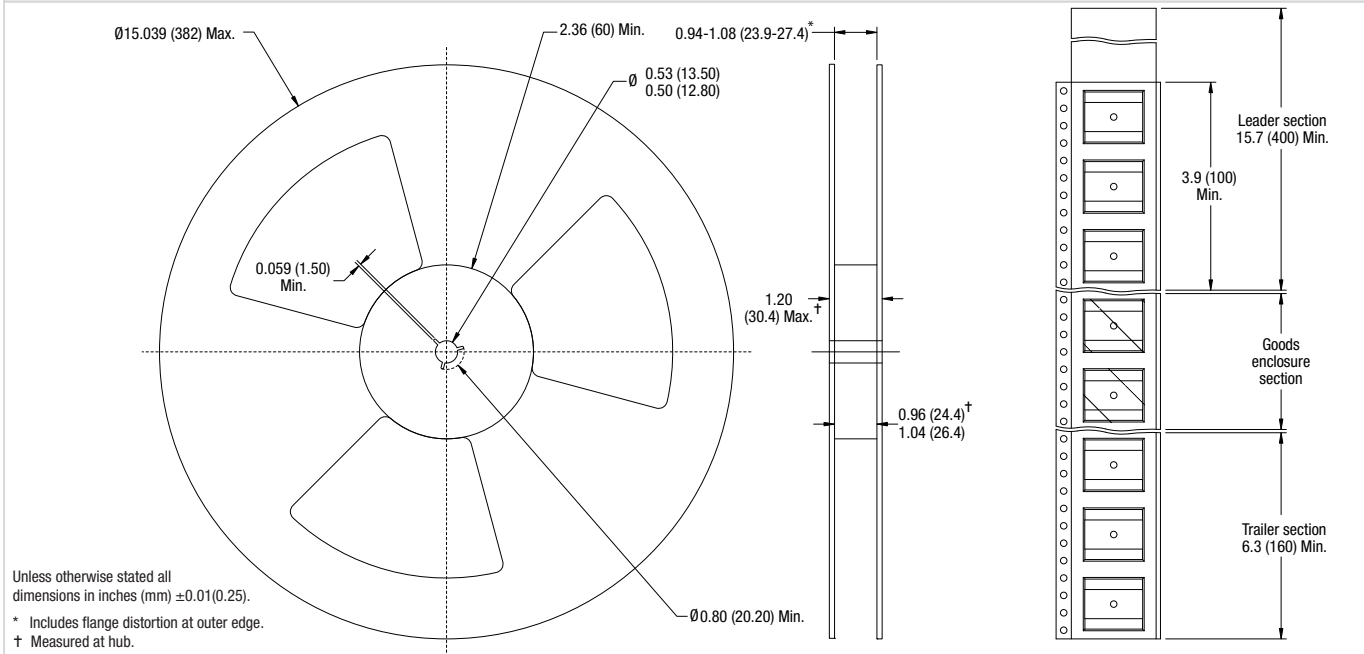

TAPE OUTLINE DIMENSIONS

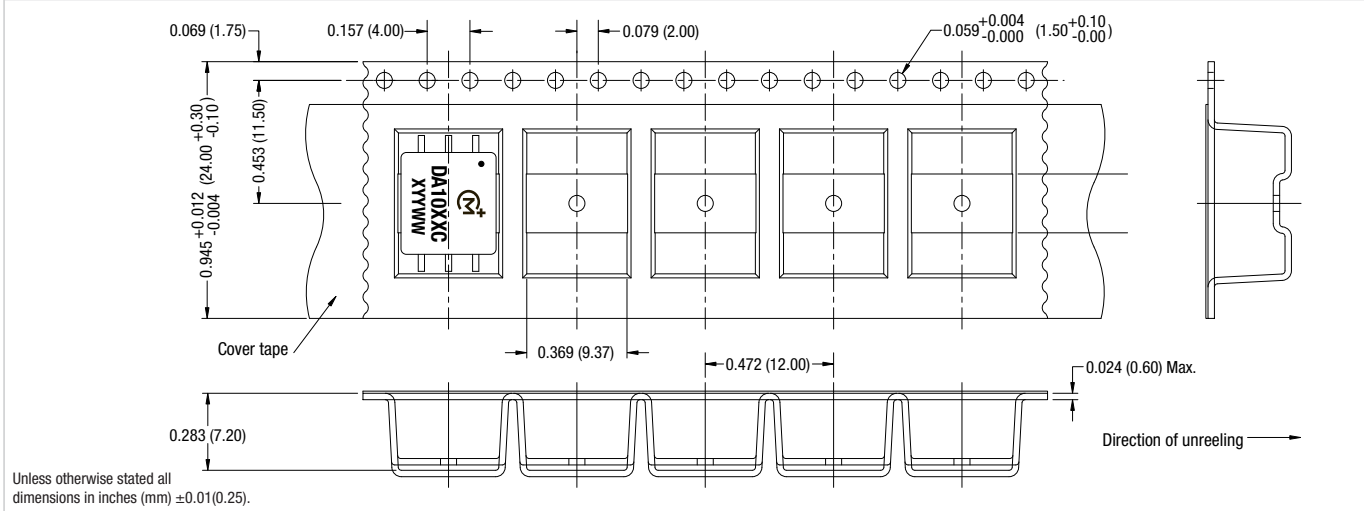

Murata Power Solutions, Inc.
11 Cabot Boulevard, Mansfield, MA 02048-1151 U.S.A.
ISO 9001 and 14001 REGISTERED

Murata Power Solutions, Inc. makes no representation that the use of its products in the circuits described herein, or the use of other technical information contained herein, will not infringe upon existing or future patent rights. The descriptions contained herein do not imply the granting of licenses to make, use, or sell equipment constructed in accordance therewith. Specifications are subject to change without notice.
© 2010 Murata Power Solutions, Inc.