

PKU 4000 Series DC/DC converters, Input 36-75 V, Output 25 A/50 W	EN/LZT 146 308 R4B July 2008 © Ericsson Power Modules AB
--	---

**Key Features**

- Industry standard Sixteenth-brick  
33.02 x 22.86 x 9.90 mm (1.3 x 0.9 x 0.39 in.)
- Wide output adjust, e.g. 3.3V +10/-40%
- 1500 Vdc input to output isolation
- Meets isolation requirements equivalent to basic insulation according to IEC/EN/UL 60950
- More than 1.61 million hours MTBF

**General Characteristics**

- Pre-biased start-up capability
- Output over voltage protection
- Input under voltage shut-down
- Over temperature protection
- Monotonic start-up
- Output short-circuit protection
- Remote sense
- Remote control
- Output voltage adjust function
- Highly automated manufacturing ensures quality
- ISO 9001/14001 certified supplier

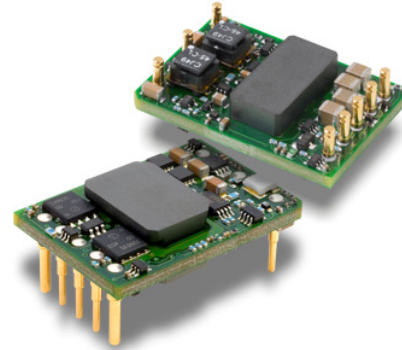

**Safety Approvals**



**Design for Environment**



Meets requirements in high-temperature lead-free soldering processes.

**Contents**

General Information	2
Safety Specification	3
Absolute Maximum Ratings	4
<b>Product Program</b>	<b>Ordering No.</b>
1.2V, 25A / 30W Electrical Specification	PKU 4318L ..... 5
1.5V, 25A / 37.5W Electrical Specification	PKU 4318H..... 8
1.8V, 25A / 45W Electrical Specification	PKU 4418G..... 11
2.5V, 15A / 37.5W Electrical Specification	PKU 4319 ..... 14
3.3V, 15A / 50W Electrical Specification	PKU 4510 ..... 17
5.0V, 10A / 50W Electrical Specification	PKU 4511 ..... 20
12.0V, 4.2A / 50W Electrical Specification	PKU 4513 ..... 23
15.0V, 3.3A / 50W Electrical Specification	PKU 4515 ..... 26
EMC Specification	29
Operating Information	30
Thermal Consideration	32
Connections	33
Mechanical Information	34
Soldering Information	36
Delivery Information	37
Product Qualification Specification	38

PKU 4000 Series  
DC/DC converters, Input 36-75 V, Output 25 A/50 W

EN/LZT 146 308 R4B July 2008

© Ericsson Power Modules AB

## General Information

### Ordering Information

See Contents for individual product ordering numbers.

Option	Suffix	Ordering No.
Isolated Surface mount	SI	PKU 4510 SI
Positive Remote Control Logic	P	PKU 4510 PIP
Lead length 3.69 mm (0.145 in)	LA	PKU 4510 PILA
Lead length 4.57 mm (0.180 in)	LB	PKU 4510 PILB

Note: As an example a through-hole mounted, positive logic, short pin product would be PKU 4510 PIPLA.

### Reliability

The Mean Time Between Failure (MTBF) is calculated at full output power and an operating ambient temperature ( $T_A$ ) of +40°C, which is a typical condition in Information and Communication Technology (ICT) equipment. Different methods could be used to calculate the predicted MTBF and failure rate which may give different results. Ericsson Power Modules currently uses Telcordia SR332.

Predicted MTBF for the series is:

- 1.61 million hours according to Telcordia SR332, issue 1, Black box technique.

Telcordia SR332 is a commonly used standard method intended for reliability calculations in ICT equipment. The parts count procedure used in this method was originally modelled on the methods from MIL-HDBK-217F, Reliability Predictions of Electronic Equipment. It assumes that no reliability data is available on the actual units and devices for which the predictions are to be made, i.e. all predictions are based on generic reliability parameters.

### Compatibility with RoHS requirements

The products are compatible with the relevant clauses and requirements of the RoHS directive 2002/95/EC and have a maximum concentration value of 0.1% by weight in homogeneous materials for lead, mercury, hexavalent chromium, PBB and PBDE and of 0.01% by weight in homogeneous materials for cadmium.

Exemptions in the RoHS directive utilized in Ericsson Power Modules products include:

- Lead in high melting temperature type solder (used to solder the die in semiconductor packages)
- Lead in glass of electronics components and in electronic ceramic parts (e.g. fill material in chip resistors)
- Lead as an alloying element in copper alloy containing up to 4% lead by weight (used in connection pins made of Brass)

### Quality Statement

The products are designed and manufactured in an industrial environment where quality systems and methods like ISO 9000, 6 $\sigma$  (sigma), and SPC are intensively in use to boost the continuous improvements strategy. Infant mortality or early failures in the products are screened out and they are subjected to an ATE-based final test. Conservative design rules, design reviews and product qualifications, plus the high competence of an engaged work force, contribute to the high quality of our products.

### Warranty

Warranty period and conditions are defined in Ericsson Power Modules General Terms and Conditions of Sale.

### Limitation of Liability

Ericsson Power Modules does not make any other warranties, expressed or implied including any warranty of merchantability or fitness for a particular purpose (including, but not limited to, use in life support applications, where malfunctions of product can cause injury to a person's health or life).

PKU 4000 Series  
DC/DC converters, Input 36-75 V, Output 25 A/50 W

EN/LZT 146 308 R4B July 2008

© Ericsson Power Modules AB

## Safety Specification

### General information

Ericsson Power Modules DC/DC converters and DC/DC regulators are designed in accordance with safety standards IEC/EN/UL60950, *Safety of Information Technology Equipment*.

IEC/EN/UL60950 contains requirements to prevent injury or damage due to the following hazards:

- Electrical shock
- Energy hazards
- Fire
- Mechanical and heat hazards
- Radiation hazards
- Chemical hazards

On-board DC-DC converters are defined as component power supplies. As components they cannot fully comply with the provisions of any Safety requirements without "Conditions of Acceptability". It is the responsibility of the installer to ensure that the final product housing these components complies with the requirements of all applicable Safety standards and Directives for the final product.

Component power supplies for general use should comply with the requirements in IEC60950, EN60950 and UL60950 "Safety of information technology equipment".

There are other more product related standards, e.g. IEEE802.3af "Ethernet LAN/MAN Data terminal equipment power", and ETS300132-2 "Power supply interface at the input to telecommunications equipment; part 2: DC", but all of these standards are based on IEC/EN/UL60950 with regards to safety.

Ericsson Power Modules DC/DC converters and DC/DC regulators are UL60950 recognized and certified in accordance with EN60950.

The flammability rating for all construction parts of the products meets requirements for V-0 class material according to IEC 60695-11-10.

The products should be installed in the end-use equipment, in accordance with the requirements of the ultimate application. Normally the output of the DC/DC converter is considered as SELV (Safety Extra Low Voltage) and the input source must be isolated by minimum Double or Reinforced Insulation from the primary circuit (AC mains) in accordance with IEC/EN/UL60950.

### Isolated DC/DC converters

It is recommended that a slow blow fuse with a rating twice the maximum input current per selected product be used at the input of each DC/DC converter. If an input filter is used in the circuit the fuse should be placed in front of the input filter.

In the rare event of a component problem in the input filter or in the DC/DC converter that imposes a short circuit on the input source, this fuse will provide the following functions:

- Isolate the faulty DC/DC converter from the input power source so as not to affect the operation of other parts of the system.
- Protect the distribution wiring from excessive current and power loss thus preventing hazardous overheating.

The galvanic isolation is verified in an electric strength test. The test voltage ( $V_{iso}$ ) between input and output is 1500 Vdc or 2250 Vdc for 60 seconds (refer to product specification).

Leakage current is less than 1  $\mu$ A at nominal input voltage.

### 24 V DC systems

The input voltage to the DC/DC converter is SELV (Safety Extra Low Voltage) and the output remains SELV under normal and abnormal operating conditions.

### 48 and 60 V DC systems

If the input voltage to Ericsson Power Modules DC/DC converter is 75 Vdc or less, then the output remains SELV (Safety Extra Low Voltage) under normal and abnormal operating conditions.

Single fault testing in the input power supply circuit should be performed with the DC/DC converter connected to demonstrate that the input voltage does not exceed 75 Vdc.

If the input power source circuit is a DC power system, the source may be treated as a TNV2 circuit and testing has demonstrated compliance with SELV limits and isolation requirements equivalent to Basic Insulation in accordance with IEC/EN/UL60950.

### Non-isolated DC/DC regulators

The input voltage to the DC/DC regulator is SELV (Safety Extra Low Voltage) and the output remains SELV under normal and abnormal operating conditions.

PKU 4000 Series DC/DC converters, Input 36-75 V, Output 25 A/50 W	EN/LZT 146 308 R4B July 2008 © Ericsson Power Modules AB
--	---

**Absolute Maximum Ratings**

Characteristics		min	typ	max	Unit
$T_{ref}$	Operating Temperature (see Thermal Consideration section)	-45		+120	°C
$T_S$	Storage temperature	-55		+125	°C
$V_I$	Input voltage	-0.5		+80	V
$V_{iso}$	Isolation voltage (input to output test voltage)			1500	Vdc
$V_{tr}$	Input voltage transient ( $t_p$ 100 ms)			100	V
$V_{RC}$	Remote Control pin voltage (see Operating Information section)	Positive logic option		25	V
		Negative logic option	-0.5	25	V
$V_{adj}$	Adjust pin voltage (see Operating Information section)	-0.5		6	V

Stress in excess of Absolute Maximum Ratings may cause permanent damage. Absolute Maximum Ratings, sometimes referred to as no destruction limits, are normally tested with one parameter at a time exceeding the limits of Output data or Electrical Characteristics. If exposed to stress above these limits, function and performance may degrade in an unspecified manner.

**Fundamental Circuit Diagram**

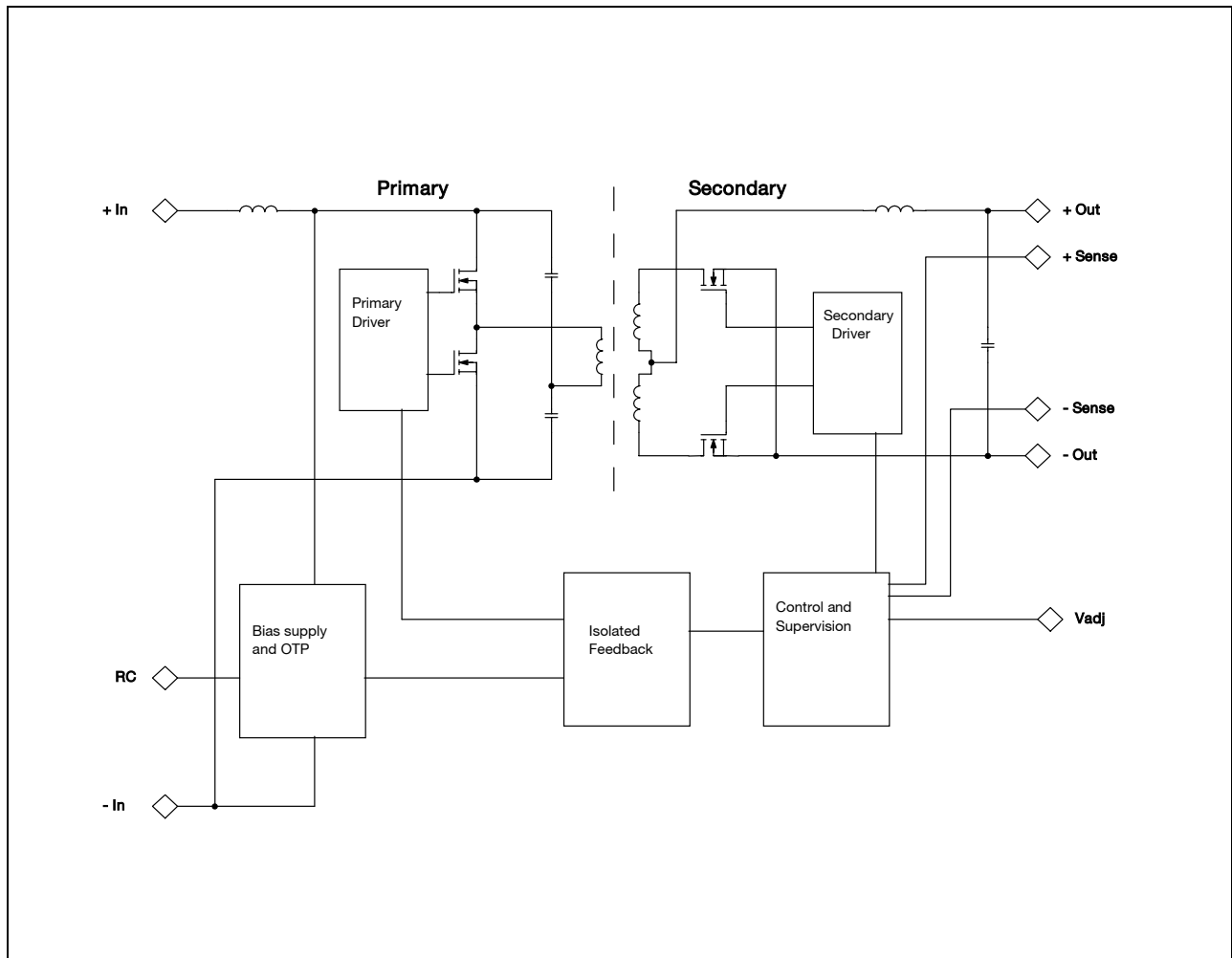

PKU 4000 Series DC/DC converters, Input 36-75 V, Output 25 A/50 W	EN/LZT 146 308 R4B July 2008 © Ericsson Power Modules AB
--	---

**1.2 V/25 A Electrical Specification**
**PKU 4318L PI**

$T_{ref} = -30$  to  $+110^{\circ}\text{C}$ ,  $V_I = 36$  to  $75$  V, sense pins connected to output pins unless otherwise specified under Conditions.  
 Typical values given at:  $T_{ref} = +25^{\circ}\text{C}$ ,  $V_I = 53$  V, max  $I_O$ , unless otherwise specified under Conditions.  
 An external capacitor of  $1\ \mu\text{F}$  is used on the input during all measurements.

Characteristics		Conditions	min	typ	Max	Unit
$V_I$	Input voltage range		36		75	V
$V_{loff}$	Turn-off input voltage	Decreasing input voltage see Note 1	29	31	33	V
$V_{lon}$	Turn-on input voltage	Increasing input voltage see Note 1	32	33	34.5	V
$C_I$	Internal input capacitance			0.5		$\mu\text{F}$
$P_O$	Output power	Output voltage initial setting	0		30	W
$\eta$	Efficiency	50 % of max $I_O$		83.5		%
		max $I_O$		82.5		
		50 % of max $I_O$ , $V_I = 48$ V		84		
		max $I_O$ , $V_I = 48$ V		83		
$P_d$	Power Dissipation	max $I_O$		6.3	10	W
$P_{li}$	Input idling power	$I_O = 0$ A, $V_I = 53$ V		1.8		W
$P_{RC}$	Input standby power	$V_I = 53$ V (turned off with RC)		0.13		W
$f_s$	Switching frequency	0-100 % of max $I_O$	290	320	350	kHz

$V_{O1}$	Output voltage initial setting and accuracy	$T_{ref} = +25^{\circ}\text{C}$ , $V_I = 53$ V, max $I_O$	1.176	1.20	1.224	V
$V_O$	Output adjust range	See operating information	1.00		1.32	V
	Output voltage tolerance band	0-100 % of max $I_O$	1.16		1.24	V
	Idling voltage	$I_O = 0$ A	1.18		1.22	V
	Line regulation	max $I_O$		5	12	mV
	Load regulation	$V_I = 53$ V, 0-100 % of max $I_O$		5	10	mV
$V_{tr}$	Load transient voltage deviation	$V_I = 53$ V, Load step 25-75-25 % of max $I_O$ , $di/dt = 7$ A/ $\mu\text{s}$ ,		$\pm 160$	$\pm 250$	mV
$t_{tr}$	Load transient recovery time			25	50	$\mu\text{s}$
$t_r$	Ramp-up time (from 10-90 % of $V_O$ )	0-100 % of max $I_O$	5	6	7	ms
$t_s$	Start-up time (from $V_I$ connection to 90 % of $V_O$ )		9	10	11	ms
$t_f$	$V_I$ shut-down fall time (from $V_I$ off to 10 % of $V_O$ )	max $I_O$	0.05	0.1	0.2	ms
		$I_O = 10$ % of max $I_O$	0.3	0.7	1.0	ms
$t_{RC}$	RC start-up time	max $I_O$		5		ms
	RC shut-down fall time (from RC off to 10 % of $V_O$ )	max $I_O$		0.5		ms
		$I_O = 10$ % of max $I_O$		0.5		ms
$I_O$	Output current		0		25	A
$I_{lim}$	Current limit threshold	$T_{ref} < \max T_{ref}$	26	31	35	A
$I_{sc}$	Short circuit current	$T_{ref} = 25^{\circ}\text{C}$ , see Note 2		20		A
$V_{Oac}$	Output ripple & noise	See ripple & noise section, max $I_O$ , $V_{O1}$		70	130	mVp-p
OVP	Over voltage protection	$T_{ref} = +25^{\circ}\text{C}$ , $V_I = 53$ V, 0-100 % of max $I_O$		1.55		V

Note 1: See Operating information section Turn-off Input Voltage.

 Note 2: RMS current in hiccup mode,  $V_O$  lower than approx 0.5 V.

PKU 4000 Series DC/DC converters, Input 36-75 V, Output 25 A/50 W	EN/LZT 146 308 R4B July 2008 © Ericsson Power Modules AB
--	---

**1.2 V/25 A Typical Characteristics**

**PKU 4318L PI**

**Efficiency**

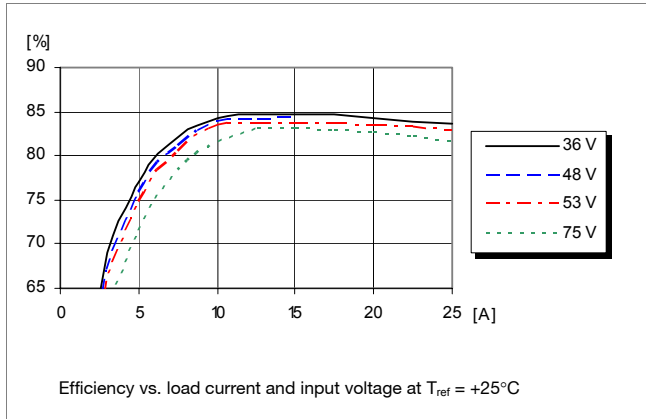

**Power Dissipation**

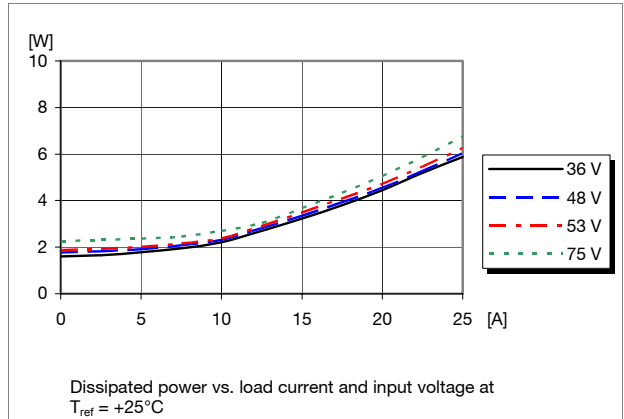

**Output Current Derating**

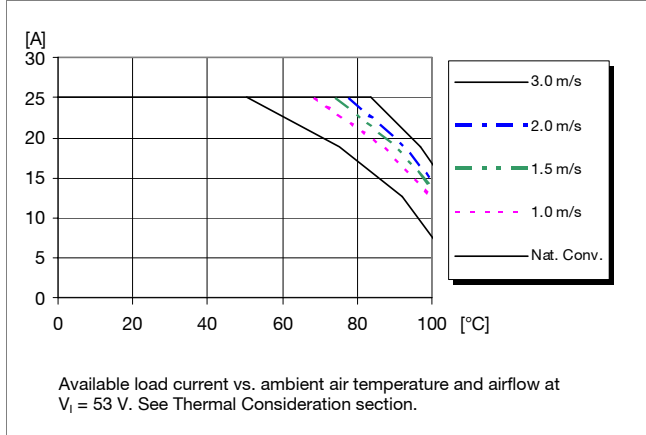

**Thermal Resistance**

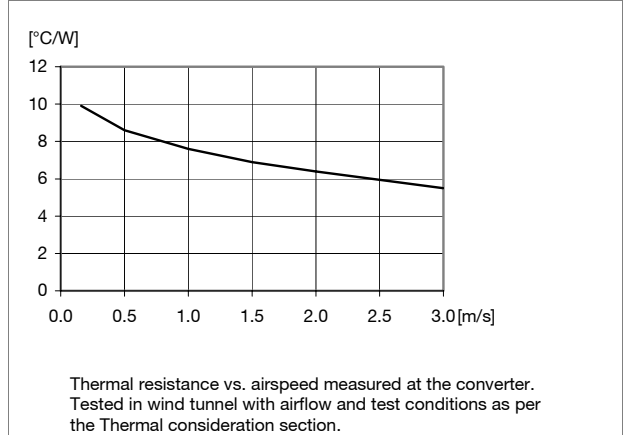

**Output Characteristics**

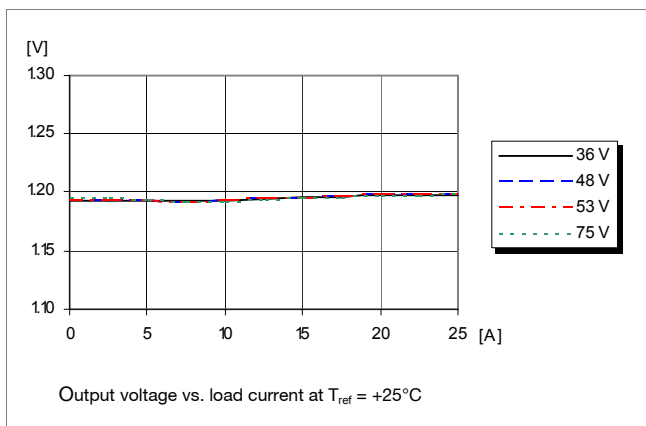

**Current Limit Characteristics**

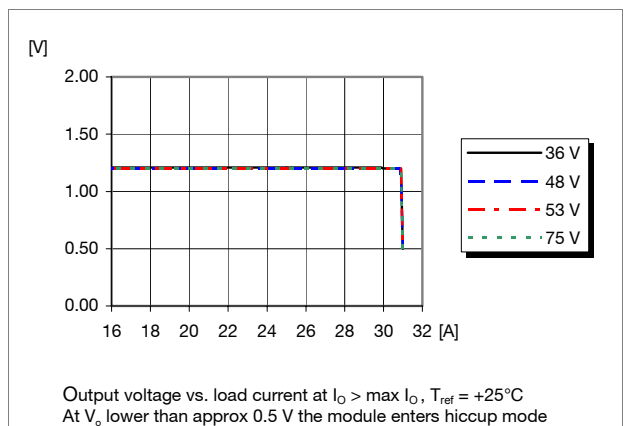

PKU 4000 Series DC/DC converters, Input 36-75 V, Output 25 A/50 W	EN/LZT 146 308 R4B July 2008 © Ericsson Power Modules AB
--	---

**1.2 V/25 A Typical Characteristics**

**PKU 4318 L PI**

**Start-up**

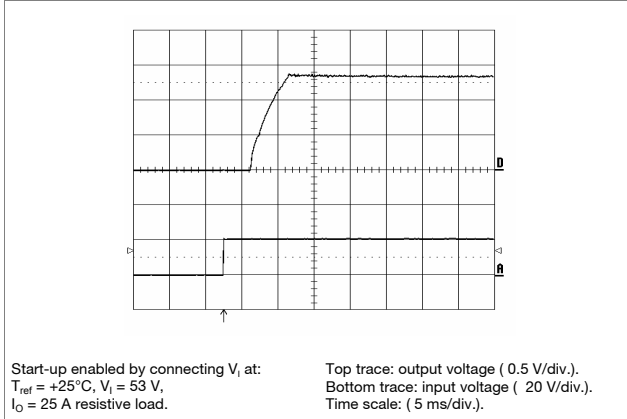

**Shut-down**

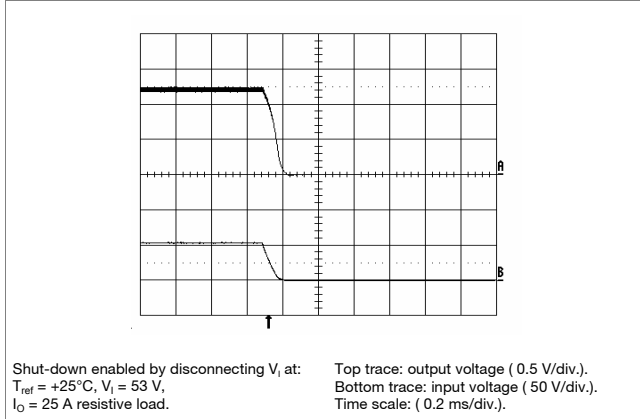

**Output Ripple & Noise**

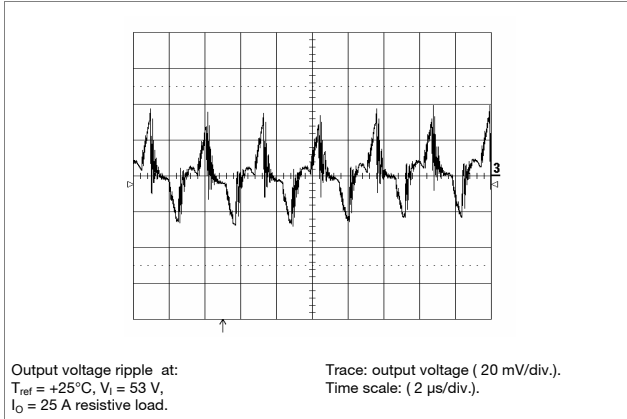

**Output Load Transient Response**

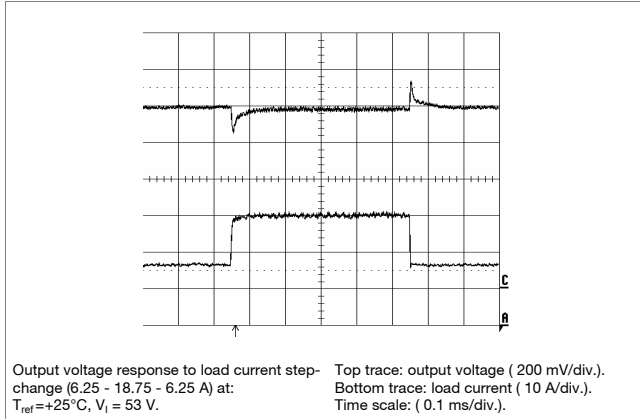

**Output Voltage Adjust (see operating information)**

**Passive adjust**

The resistor value for an adjusted output voltage is calculated by using the following equations:

Output Voltage Adjust Upwards, Increase:

$$R_{adj} = \left( \frac{5.11 \times 1.20(100 + \Delta\%)}{1.225 \times \Delta\%} - \frac{511}{\Delta\%} - 10.22 \right) \text{ k}\Omega$$

Example: Increase 4% =>  $V_{out} = 1.248\text{ Vdc}$

$$\left( \frac{5.11 \times 1.20(100 + 4)}{1.225 \times 4} - \frac{511}{4} - 10.22 \right) \text{ k}\Omega = 128 \text{ k}\Omega$$

Output Voltage Adjust Downwards, Decrease:

$$R_{adj} = \left( \frac{511}{\Delta\%} \right) - 10.22 \text{ k}\Omega$$

Example: Decrease 2% =>  $V_{out} = 1.176\text{ Vdc}$

$$\left( \frac{511}{2} \right) - 10.22 \text{ k}\Omega = 245 \text{ k}\Omega$$

**Active adjust**

The output voltage may be adjusted using a voltage applied to the  $V_{adj}$  pin. This voltage is calculated by using the following equation:

$$V_{adj} = \left( 1.225 + 2.45 \times \frac{V_{desired} - 1.20}{1.20} \right) \text{ V}$$

Example: Upwards => 1.30 V

$$\left( 1.225 + 2.45 \times \frac{1.30 - 1.20}{1.20} \right) \text{ V} = 1.43 \text{ V}$$

Example: Downwards => 1.0 V

$$\left( 1.225 + 2.45 \times \frac{1.00 - 1.20}{1.20} \right) \text{ V} = 0.82 \text{ V}$$

PKU 4000 Series DC/DC converters, Input 36-75 V, Output 25 A/50 W	EN/LZT 146 308 R4B July 2008
	© Ericsson Power Modules AB

**1.5 V/25 A Electrical Specification**
**PKU 4318H PI**

$T_{ref} = -30$  to  $+110^{\circ}\text{C}$ ,  $V_I = 36$  to  $75$  V, sense pins connected to output pins unless otherwise specified under Conditions.  
 Typical values given at:  $T_{ref} = +25^{\circ}\text{C}$ ,  $V_I = 53$  V, max  $I_O$ , unless otherwise specified under Conditions.  
 An external capacitor of  $1\ \mu\text{F}$  is used on the input during all measurements.

Characteristics		Conditions	min	typ	Max	Unit
$V_I$	Input voltage range		36		75	V
$V_{loff}$	Turn-off input voltage	Decreasing input voltage see Note 1	29	31	33	V
$V_{lon}$	Turn-on input voltage	Increasing input voltage See Note 1	32	33	34.5	V
$C_I$	Internal input capacitance			0.5		$\mu\text{F}$
$P_O$	Output power	Output voltage initial setting	0		37.5	W
$\eta$	Efficiency	50 % of max $I_O$		86		%
		max $I_O$		85		
		50 % of max $I_O$ , $V_I = 48$ V		86		
		max $I_O$ , $V_I = 48$ V		85		
$P_d$	Power Dissipation	max $I_O$		6.7	10	W
$P_{li}$	Input idling power	$I_O = 0$ A, $V_I = 53$ V		2		W
$P_{RC}$	Input standby power	$V_I = 53$ V (turned off with RC)		0.15		W
$f_s$	Switching frequency	0-100 % of max $I_O$	290	320	350	kHz

$V_{O1}$	Output voltage initial setting and accuracy	$T_{ref} = +25^{\circ}\text{C}$ , $V_I = 53$ V, max $I_O$	1.47	1.50	1.53	V
$V_O$	Output adjust range	See operating information	1.00		1.65	V
	Output voltage tolerance band	0-100 % of max $I_O$	1.455		1.545	V
	Idling voltage	$I_O = 0$ A	1.48		1.52	V
	Line regulation	max $I_O$		5	12	mV
	Load regulation	$V_I = 53$ V, 0-100 % of max $I_O$		5	10	mV
$V_{tr}$	Load transient voltage deviation	$V_I = 53$ V, Load step 25-75-25 % of max $I_O$ , $di/dt = 7$ A/ $\mu\text{s}$ ,		$\pm 120$	$\pm 250$	mV
$t_{tr}$	Load transient recovery time			15	50	$\mu\text{s}$
$t_r$	Ramp-up time (from 10-90 % of $V_O$ )	0-100 % of max $I_O$	3.5	5	6	ms
$t_s$	Start-up time (from $V_I$ connection to 90 % of $V_O$ )		7	9	10	ms
$t_f$	$V_I$ shut-down fall time (from $V_I$ off to 10 % of $V_O$ )	max $I_O$	0.05	0.1	0.2	ms
		$I_O = 10$ % of max $I_O$		0.7		ms
$t_{RC}$	RC start-up time	max $I_O$		5		ms
	RC shut-down fall time (from RC off to 10 % of $V_O$ )	max $I_O$		0.6		ms
		$I_O = 10$ % of max $I_O$		0.65		ms
$I_O$	Output current		0		25	A
$I_{lim}$	Current limit threshold	$T_{ref} < \max T_{ref}$	26	31	35	A
$I_{sc}$	Short circuit current	$T_{ref} = 25^{\circ}\text{C}$ , see Note 2		20		A
$V_{Oac}$	Output ripple & noise	See ripple & noise section, max $I_O$ , $V_{O1}$		80	150	mVp-p
OVP	Over voltage protection	$T_{ref} = +25^{\circ}\text{C}$ , $V_I = 53$ V, 0-100 % of max $I_O$		1.9		V

Note 1: See Operating information section Turn-off Input Voltage.

Note 2: RMS current in hiccup mode,  $V_O$  lower than approx 0.5 V.



PKU 4000 Series DC/DC converters, Input 36-75 V, Output 25 A/50 W	EN/LZT 146 308 R4B July 2008 © Ericsson Power Modules AB
--	---

**1.5 V/25 A Typical Characteristics**

**PKU 4318H PI**

**Efficiency**

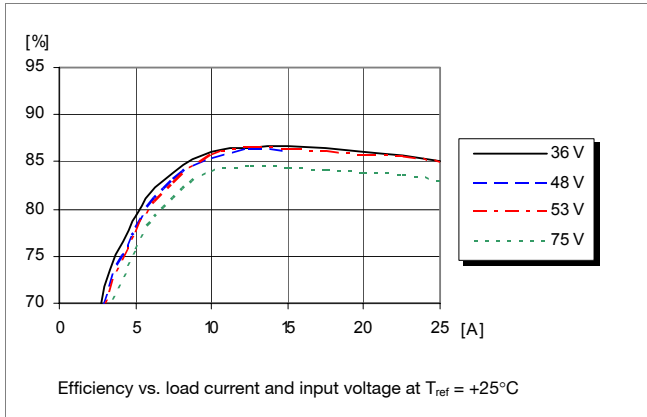

**Power Dissipation**

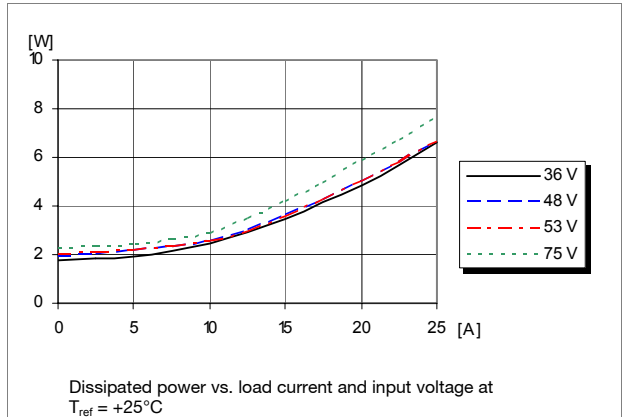

**Output Current Derating**

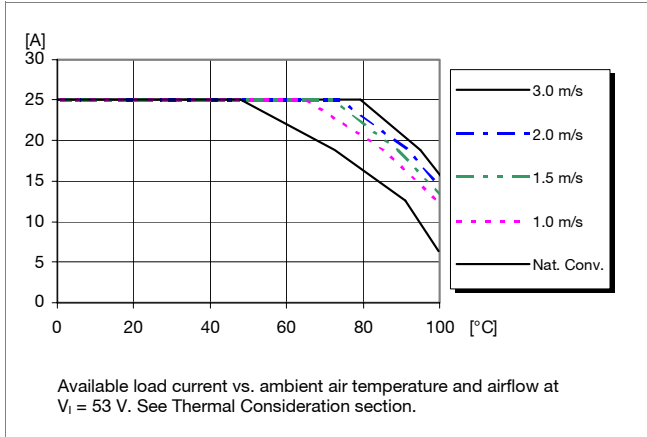

**Thermal Resistance**

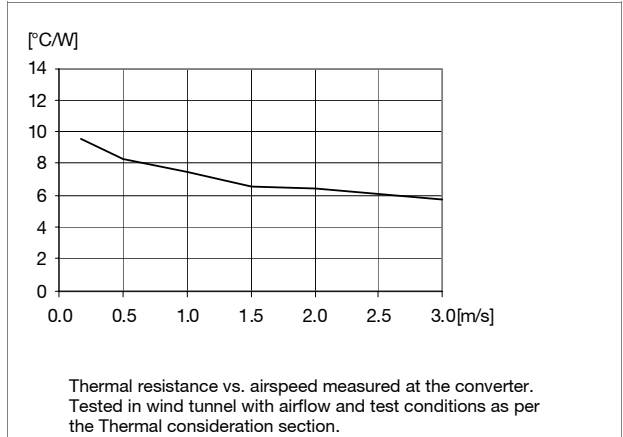

**Output Characteristics**

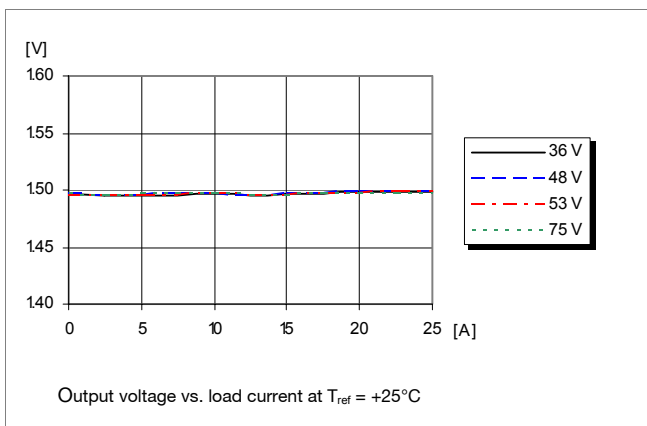

**Current Limit Characteristics**

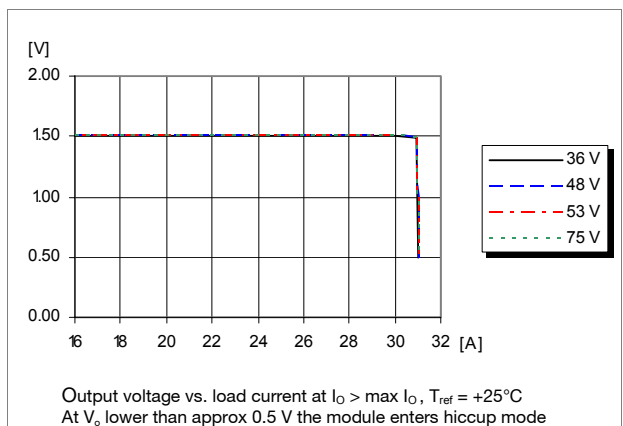

PKU 4000 Series  
DC/DC converters, Input 36-75 V, Output 25 A/50 W

EN/LZT 146 308 R4B July 2008  
© Ericsson Power Modules AB

**1.5 V/25 A Typical Characteristics**

**PKU 4318H PI**

**Start-up**

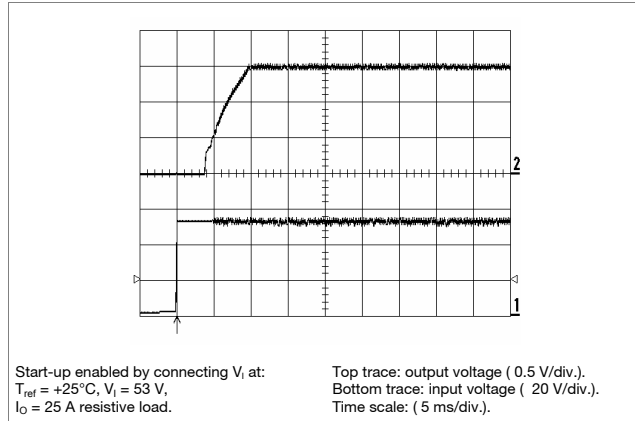

**Shut-down**

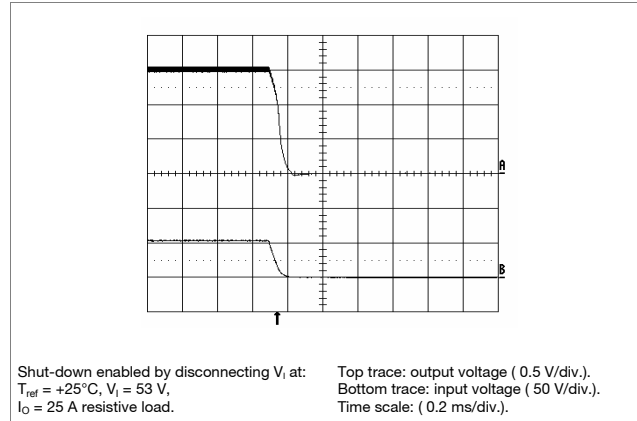

**Output Ripple & Noise**

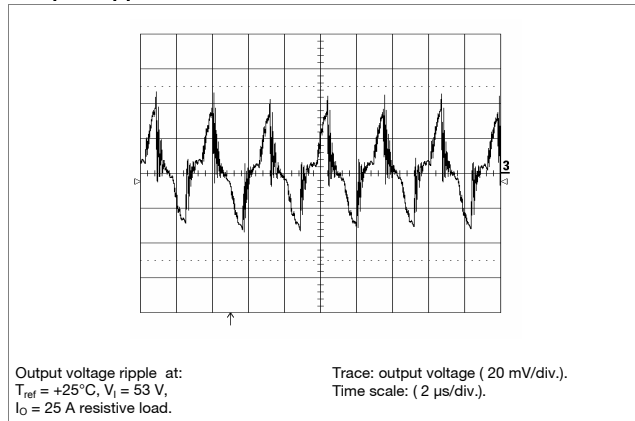

**Output Load Transient Response**

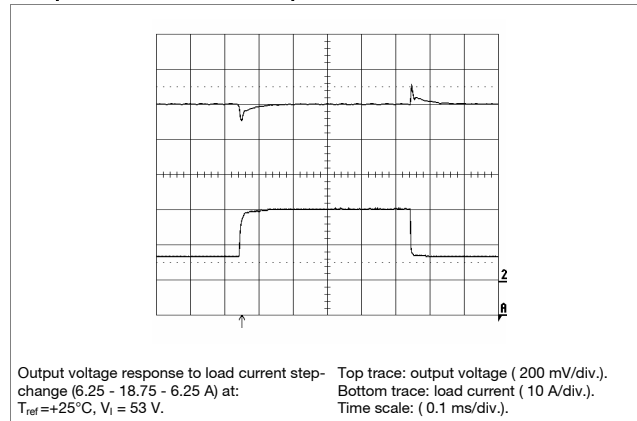

**Output Voltage Adjust (see operating information)**

**Passive adjust**

The resistor value for an adjusted output voltage is calculated by using the following equations:

Output Voltage Adjust Upwards, Increase:

$$R_{adj} = \left( \frac{5.11 \times 1.50(100 + \Delta\%)}{1.225 \times \Delta\%} - \frac{511}{\Delta\%} - 10.22 \right) \text{ k}\Omega$$

Example: Increase 4% =>  $V_{out} = 1.56\text{ Vdc}$

$$\left( \frac{5.11 \times 1.50(100 + 4)}{1.225 \times 4} - \frac{511}{4} - 10.22 \right) \text{ k}\Omega = 24.7 \text{ k}\Omega$$

Output Voltage Adjust Downwards, Decrease:

$$R_{adj} = \left( \frac{511}{\Delta\%} \right) - 10.22 \text{ k}\Omega$$

Example: Decrease 2% =>  $V_{out} = 1.47\text{ Vdc}$

$$\left( \frac{511}{2} \right) - 10.22 \text{ k}\Omega = 245 \text{ k}\Omega$$

**Active adjust**

The output voltage may be adjusted using a voltage applied to the  $V_{adj}$  pin. This voltage is calculated by using the following equation:

$$V_{adj} = \left( 1.225 + 2.45 \times \frac{V_{desired} - 1.50}{1.50} \right) \text{ V}$$

Example: Upwards => 1.60 V

$$\left( 1.225 + 2.45 \times \frac{1.60 - 1.50}{1.50} \right) \text{ V} = 1.39 \text{ V}$$

Example: Downwards => 1.0 V

$$\left( 1.225 + 2.45 \times \frac{1.00 - 1.50}{1.50} \right) \text{ V} = 0.41 \text{ V}$$

PKU 4000 Series DC/DC converters, Input 36-75 V, Output 25 A/50 W	EN/LZT 146 308 R4B July 2008
	© Ericsson Power Modules AB

**1.8 V/25 A Electrical Specification**
**PKU 4418G PI**

$T_{ref} = -30$  to  $+110^{\circ}\text{C}$ ,  $V_I = 36$  to  $75$  V, sense pins connected to output pins unless otherwise specified under Conditions.

Typical values given at:  $T_{ref} = +25^{\circ}\text{C}$ ,  $V_I = 53$  V, max  $I_O$ , unless otherwise specified under Conditions.

An external capacitor of  $1\ \mu\text{F}$  is used on the input during all measurements.

Characteristics		Conditions	min	typ	Max	Unit
$V_I$	Input voltage range		36		75	V
$V_{loff}$	Turn-off input voltage	Decreasing input voltage see Note 1	29	31	33	V
$V_{lon}$	Turn-on input voltage	Increasing input voltage see Note 1	32	33	34.5	V
$C_I$	Internal input capacitance			0.5		$\mu\text{F}$
$P_O$	Output power	Output voltage initial setting	0		45	W
$\eta$	Efficiency	50 % of max $I_O$		86.4		%
		max $I_O$		86.0		
		50 % of max $I_O$ , $V_I = 48$ V		86.8		
		max $I_O$ , $V_I = 48$ V		86.3		
$P_d$	Power Dissipation	max $I_O$		7.3	11.5	W
$P_{li}$	Input idling power	$I_O = 0$ A, $V_I = 53$ V		2.4		W
$P_{RC}$	Input standby power	$V_I = 53$ V (turned off with RC)		0.15		W
$f_s$	Switching frequency	0-100 % of max $I_O$	290	320	350	kHz

$V_{O1}$	Output voltage initial setting and accuracy	$T_{ref} = +25^{\circ}\text{C}$ , $V_I = 53$ V, max $I_O$	1.764	1.80	1.836	V
$V_O$	Output adjust range	See operating information	1.00		1.98	V
	Output voltage tolerance band	0-100 % of max $I_O$	1.75		1.85	V
	Idling voltage	$I_O = 0$ A	1.77		1.82	V
	Line regulation	max $I_O$		5	12	mV
	Load regulation	$V_I = 53$ V, 0-100 % of max $I_O$		4	10	mV
$V_{tr}$	Load transient voltage deviation	$V_I = 53$ V, Load step 25-75-25 % of max $I_O$ , $di/dt = 7$ A/ $\mu\text{s}$ ,		$\pm 120$	$\pm 250$	mV
$t_{tr}$	Load transient recovery time			20	50	$\mu\text{s}$
$t_r$	Ramp-up time (from 10-90 % of $V_O$ )	0-100 % of max $I_O$	3.5	5	6	ms
$t_s$	Start-up time (from $V_I$ connection to 90 % of $V_O$ )		7	9	10	ms
$t_f$	$V_I$ shut-down fall time (from $V_I$ off to 10 % of $V_O$ )	max $I_O$	0.05	0.1	0.2	ms
		$I_O = 10$ % of max $I_O$	0.3	0.7	1.0	ms
$t_{RC}$	RC start-up time	max $I_O$		7		ms
	RC shut-down fall time (from RC off to 10 % of $V_O$ )	max $I_O$		0.2		ms
		$I_O = 10$ % of max $I_O$		0.7		ms
$I_O$	Output current		0		25	A
$I_{lim}$	Current limit threshold	$T_{ref} < \max T_{ref}$	26	31	35	A
$I_{sc}$	Short circuit current	$T_{ref} = 25^{\circ}\text{C}$ , see Note 2		20		A
$V_{Oac}$	Output ripple & noise	See ripple & noise section, max $I_O$ , $V_{O1}$		85	150	mVp-p
OVP	Over voltage protection	$T_{ref} = +25^{\circ}\text{C}$ , $V_I = 53$ V, 0-100 % of max $I_O$		2.2		V

Note 1: See Operating information section Turn-off Input Voltage.

Note 2: RMS current in hiccup mode,  $V_O$  lower than approx 0.5 V.

PKU 4000 Series DC/DC converters, Input 36-75 V, Output 25 A/50 W	EN/LZT 146 308 R4B July 2008 © Ericsson Power Modules AB
--	---

**1.8 V/25 A Typical Characteristics**

**PKU 4418G PI**

**Efficiency**

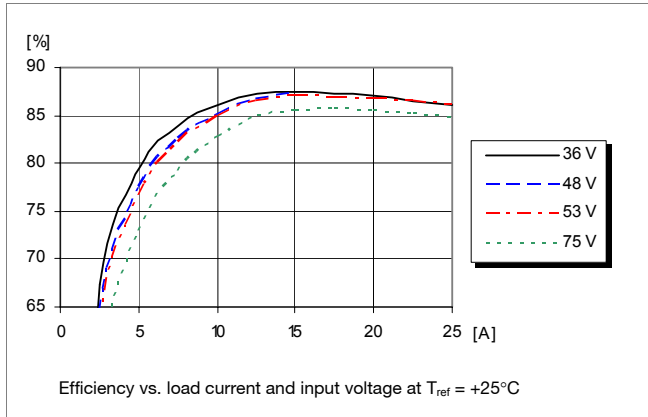

**Power Dissipation**

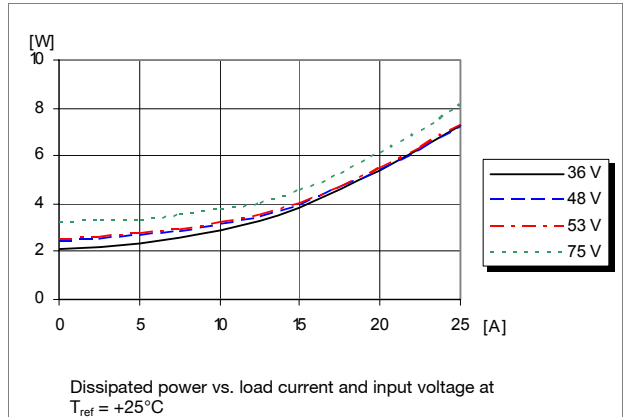

**Output Current Derating**

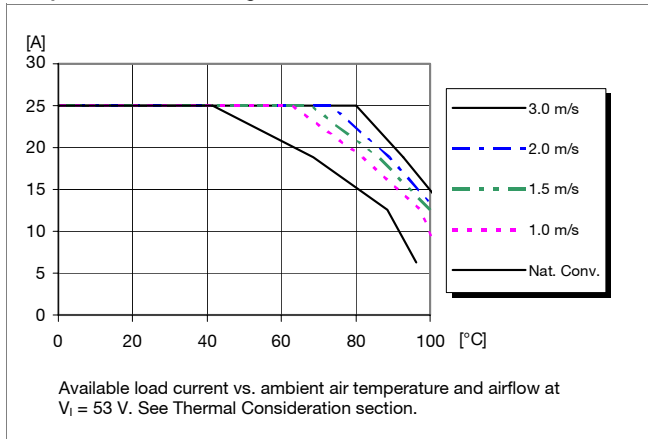

**Thermal Resistance**

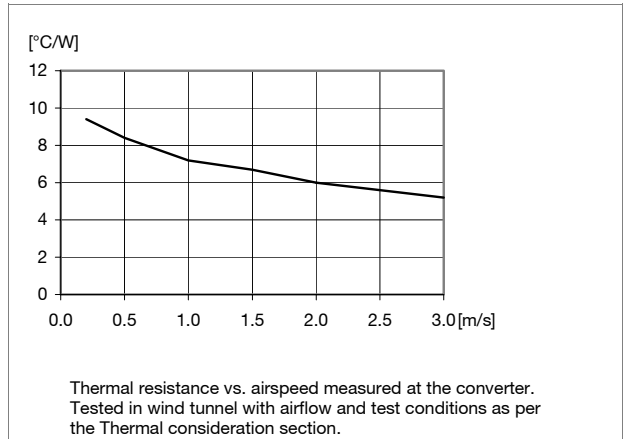

**Output Characteristics**

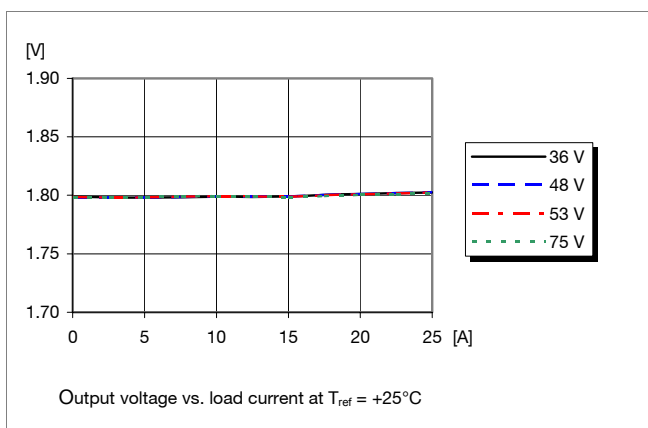

**Current Limit Characteristics**

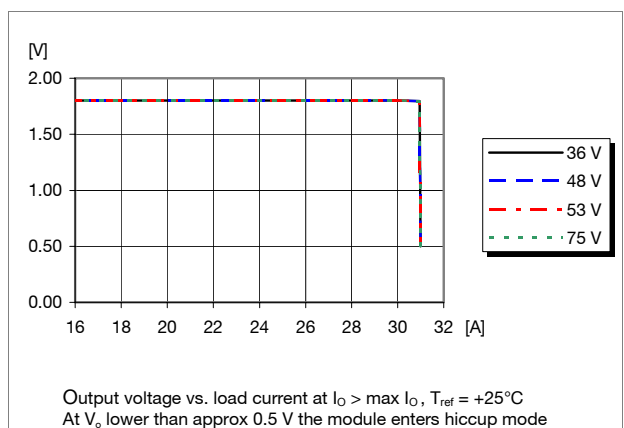

PKU 4000 Series  
DC/DC converters, Input 36-75 V, Output 25 A/50 W

EN/LZT 146 308 R4B July 2008  
© Ericsson Power Modules AB

**1.8 V/25 A Typical Characteristics**

**PKU 4418G PI**

**Start-up**

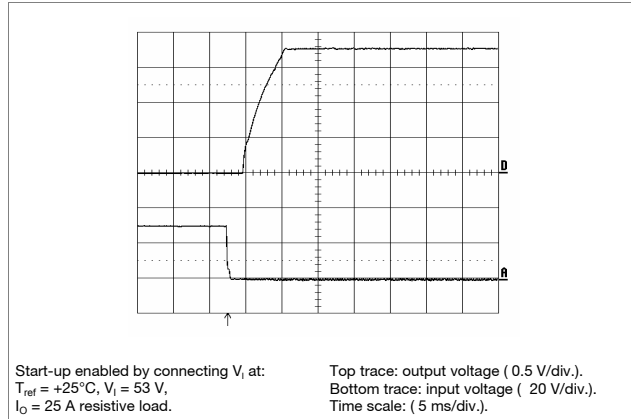

**Shut-down**

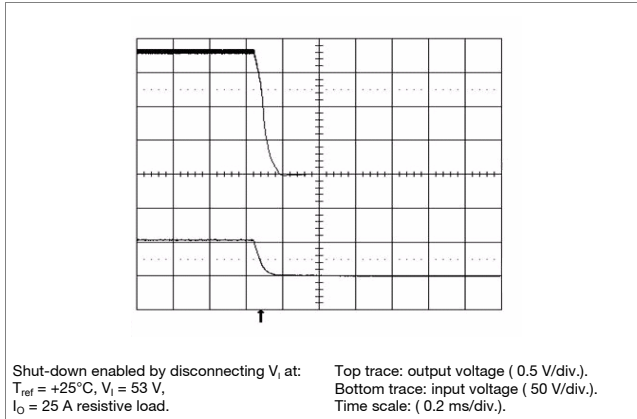

**Output Ripple & Noise**

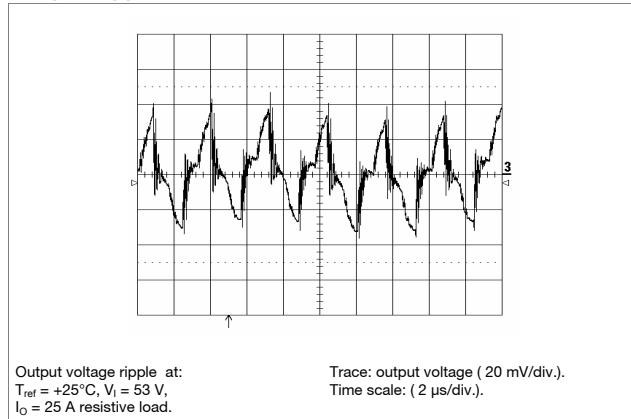

**Output Load Transient Response**

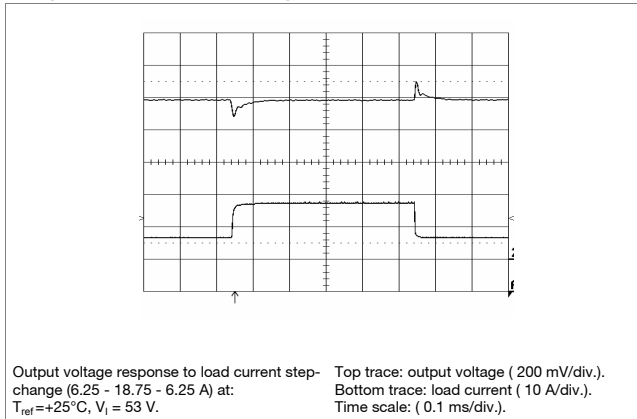

**Output Voltage Adjust (see operating information)**

**Passive adjust**

The resistor value for an adjusted output voltage is calculated by using the following equations:

Output Voltage Adjust Upwards, Increase:

$$R_{adj} = \left( \frac{5.11 \times 1.80(100 + \Delta\%)}{1.225 \times \Delta\%} - \frac{511}{\Delta\%} - 10.22 \right) \text{ k}\Omega$$

Example: Increase 4% =>  $V_{out} = 1.872\text{ V}$

$$\left( \frac{5.11 \times 1.80(100 + 4)}{1.225 \times 4} - \frac{511}{4} - 10.22 \right) \text{ k}\Omega = 57 \text{ k}\Omega$$

Output Voltage Adjust Downwards, Decrease:

$$R_{adj} = \left( \frac{511}{\Delta\%} \right) - 10.22 \text{ k}\Omega$$

Example: Decrease 2% =>  $V_{out} = 1.764\text{ V}$

$$\left( \frac{511}{2} \right) - 10.22 \text{ k}\Omega = 245 \text{ k}\Omega$$

**Active adjust**

The output voltage may be adjusted using a voltage applied to the  $V_{adj}$  pin. This voltage is calculated by using the following equation:

$$V_{adj} = \left( 1.225 + 2.45 \times \frac{V_{desired} - 1.80}{1.80} \right) \text{ V}$$

Example: Upwards => 1.90 V

$$\left( 1.225 + 2.45 \times \frac{1.90 - 1.80}{1.80} \right) \text{ V} = 1.36 \text{ V}$$

Example: Downwards => 1.0 V

$$\left( 1.225 + 2.45 \times \frac{1.00 - 1.80}{1.80} \right) \text{ V} = 0.14 \text{ V}$$

PKU 4000 Series DC/DC converters, Input 36-75 V, Output 25 A/50 W	EN/LZT 146 308 R4B July 2008
	© Ericsson Power Modules AB

**2.5 V/15 A Electrical Specification**
**PKU 4319 PI**

$T_{ref} = -30$  to  $+110^{\circ}\text{C}$ ,  $V_I = 36$  to  $75$  V, sense pins connected to output pins unless otherwise specified under Conditions.  
 Typical values given at:  $T_{ref} = +25^{\circ}\text{C}$ ,  $V_I = 53$  V, max  $I_O$ , unless otherwise specified under Conditions.  
 An external capacitor of  $1\ \mu\text{F}$  is used on the input during all measurements.

Characteristics		Conditions	min	typ	max	Unit
$V_I$	Input voltage range		36		75	V
$V_{loff}$	Turn-off input voltage	Decreasing input voltage see Note 1	29	31	33	V
$V_{lon}$	Turn-on input voltage	Increasing input voltage see Note 1	32	33	34.5	V
$C_I$	Internal input capacitance			0.5		Mf
$P_O$	Output power	Output voltage initial setting	0		37.5	W
$\eta$	Efficiency	50 % of max $I_O$		88.0		%
		max $I_O$		87.3		
		50 % of max $I_O$ , $V_I = 48$ V		88.7		
		max $I_O$ , $V_I = 48$ V		87.6		
$P_d$	Power Dissipation	max $I_O$		5.5	8.5	W
$P_{li}$	Input idling power	$I_O = 0$ A, $V_I = 53$ V		1.5		W
$P_{RC}$	Input standby power	$V_I = 53$ V, turned off with RC		0.15		W
$f_s$	Switching frequency	0-100 % of max $I_O$	290	320	350	kHz

$V_{O1}$	Output voltage initial setting and accuracy	$T_{ref} = +25^{\circ}\text{C}$ , $V_I = 53$ V, max $I_O$	2.45	2.50	2.55	V
$V_O$	Output adjust range	See operating information	1.90		3.0	V
	Output voltage tolerance band	0-100 % of max $I_O$	2.42		2.58	V
	Idling voltage	$I_O = 0$ A	2.45		2.55	V
	Line regulation	max $I_O$		1	10	mV
	Load regulation	$V_I = 53$ V, 0-100 % of max $I_O$		8	15	mV
$V_{tr}$	Load transient voltage deviation	$V_I = 53$ V, Load step 25-75-25 % of max $I_O$ , $di/dt = 1$ A/ $\mu\text{s}$ .		$\pm 125$	$\pm 250$	mV
$t_{tr}$	Load transient recovery time			20	40	$\mu\text{s}$
$t_r$	Ramp-up time (from 10-90 % of $V_{O1}$ )	0-100 % of max $I_O$	3.5	4	4.5	ms
$t_s$	Start-up time (from $V_I$ connection to 90 % of $V_{O1}$ )		7	8	9	ms
$t_f$	$V_I$ shut-down fall time (from $V_I$ off to 10 % of $V_{O1}$ )	max $I_O$	0.1	0.2	0.4	ms
		$I_O = 10$ % of max $I_O$	0.9	1.3	1.5	ms
$t_{RC}$	RC start-up time	max $I_O$		6		ms
	RC shut-down fall time (from RC off to 10 % of $V_{O1}$ )	max $I_O$		1		ms
		$I_O = 10$ % of max $I_O$		1.5		ms
$I_O$	Output current		0		15	A
$I_{lim}$	Current limit threshold	$T_{ref} < \max T_{ref}$	16	18	22	A
$I_{sc}$	Short circuit current	$T_{ref} = 25^{\circ}\text{C}$ , see Note 2		13		A
$V_{Oac}$	Output ripple & noise	See ripple & noise section, max $I_O$ , $V_{O1}$		55	100	mVp-p
OVP	Over voltage protection	$T_{ref} = +25^{\circ}\text{C}$ , $V_I = 53$ V, 0-100 % of max $I_O$		3.35		V

Note 1: See Operating Instruction, section Turn-off Input Voltage

 Note 2: RMS current in hiccup mode,  $V_O$  lower than approx 0.5 V

PKU 4000 Series DC/DC converters, Input 36-75 V, Output 25 A/50 W	EN/LZT 146 308 R4B July 2008 © Ericsson Power Modules AB
--	---

**2.5 V/15 A Typical Characteristics**

**PKU 4319 PI**

**Efficiency**

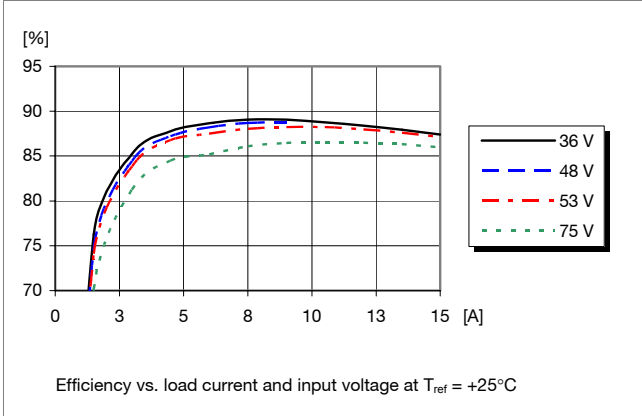

**Power Dissipation**

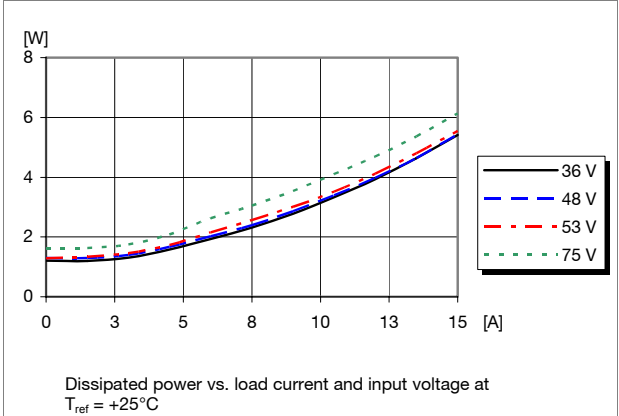

**Output Current Derating**

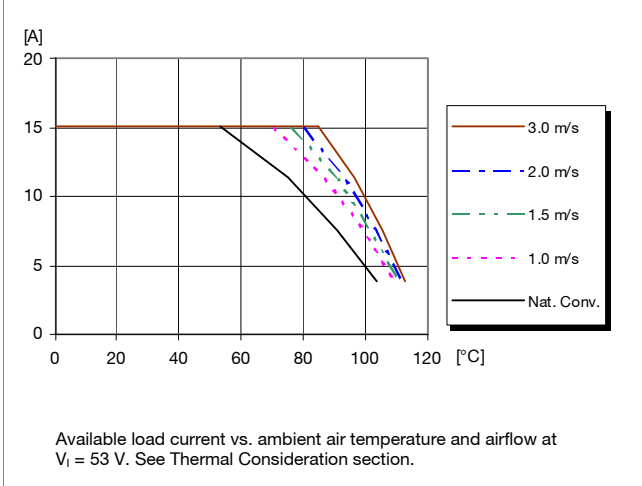

**Thermal Resistance**

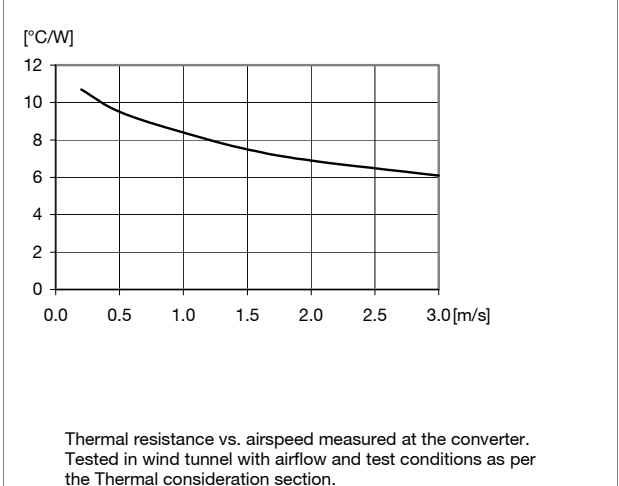

**Output Characteristics**

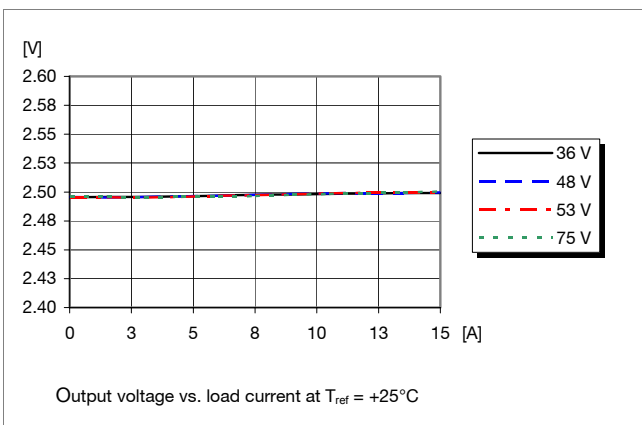

**Current Limit Characteristics**

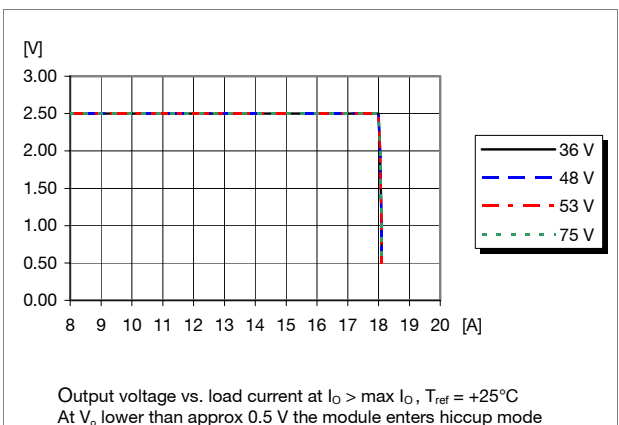

PKU 4000 Series  
DC/DC converters, Input 36-75 V, Output 25 A/50 W

EN/LZT 146 308 R4B July 2008  
© Ericsson Power Modules AB

**2.5 V/15 A Typical Characteristics**

**PKU 4319 PI**

**Start-up**

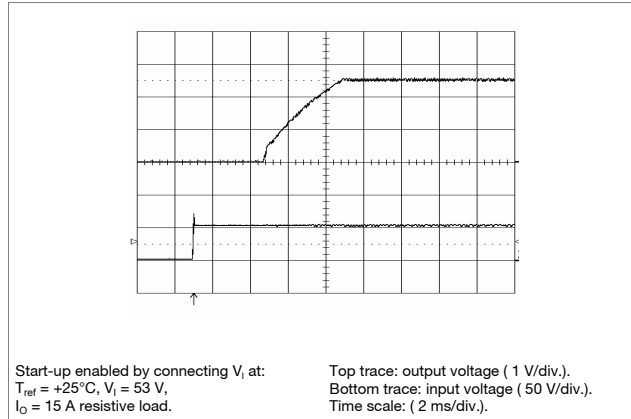

**Shut-down**

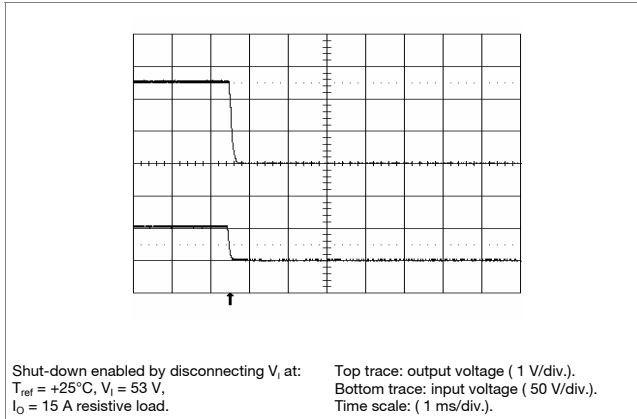

**Output Ripple & Noise**

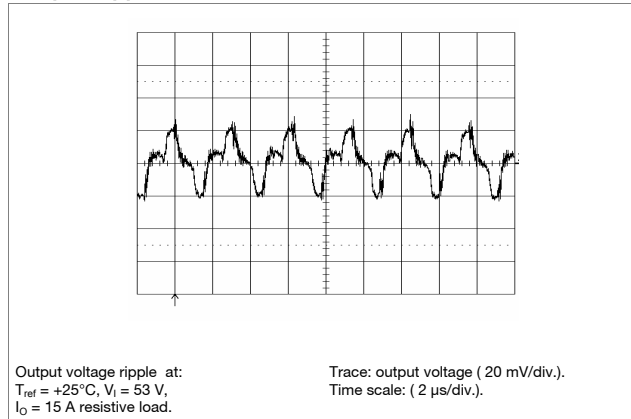

**Output Load Transient Response**

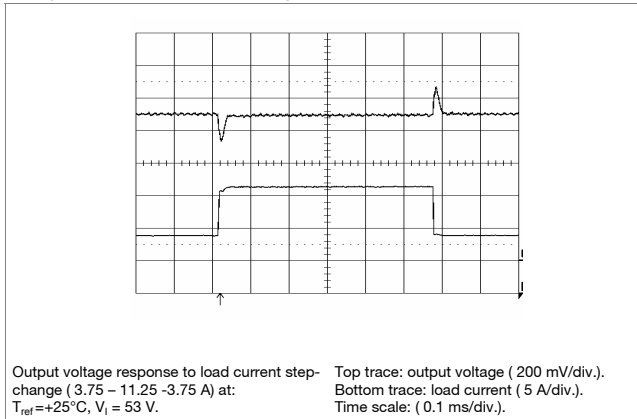

**Output Voltage Adjust (see operating information)**

**Passive adjust**

The resistor value for an adjusted output voltage is calculated by using the following equations:

Output Voltage Adjust Upwards, Increase:

$$R_{adj} = \left( \frac{5.11 \times 2.50(100 + \Delta\%)}{1.225 \times \Delta\%} - \frac{511}{\Delta\%} - 10.22 \right) \text{ k}\Omega$$

Example: Increase 4% =>  $V_{out} = 2.60\text{ Vdc}$

$$\left( \frac{5.11 \times 2.50(100 + 4)}{1.225 \times 4} - \frac{511}{4} - 10.22 \right) \text{ k}\Omega = 133 \text{ k}\Omega$$

Output Voltage Adjust Downwards, Decrease:

$$R_{adj} = \left( \frac{511}{\Delta\%} \right) - 10.22 \text{ k}\Omega$$

Example: Decrease 2% =>  $V_{out} = 2.45\text{ Vdc}$

$$\left( \frac{511}{2} \right) - 10.22 \text{ k}\Omega = 245 \text{ k}\Omega$$

**Active adjust**

The output voltage may be adjusted using a voltage applied to the  $V_{adj}$  pin. This voltage is calculated by using the following equation:

$$V_{adj} = \left( 1.225 + 2.45 \times \frac{V_{desired} - 2.50}{2.50} \right) \text{ V}$$

Example: Upwards => 2.75 V

$$\left( 1.225 + 2.45 \times \frac{2.75 - 2.50}{2.50} \right) \text{ V} = 1.47 \text{ V}$$

Example: Downwards => 2.25 V

$$\left( 1.225 + 2.45 \times \frac{2.25 - 2.50}{2.50} \right) \text{ V} = 0.98 \text{ V}$$



PKU 4000 Series DC/DC converters, Input 36-75 V, Output 25 A/50 W	EN/LZT 146 308 R4B July 2008
	© Ericsson Power Modules AB

### 3.3 V/15 A Electrical Specification

**PKU 4510 PI**

$T_{ref} = -30$  to  $+110^{\circ}\text{C}$ ,  $V_I = 36$  to  $75$  V, sense pins connected to output pins unless otherwise specified under Conditions.  
 Typical values given at:  $T_{ref} = +25^{\circ}\text{C}$ ,  $V_I = 53$  V, max  $I_O$ , unless otherwise specified under Conditions.  
 An external capacitor of  $1\ \mu\text{F}$  is used on the input during all measurements.

Characteristics		Conditions	min	typ	Max	Unit
$V_I$	Input voltage range		36		75	V
$V_{loff}$	Turn-off input voltage	Decreasing input voltage, see Note 1	29	31	33	V
$V_{lon}$	Turn-on input voltage	Increasing input voltage see Note 1	32	33	34.5	V
$C_I$	Internal input capacitance			0.5		$\mu\text{F}$
$P_O$	Output power	Output voltage initial setting	0		49.5	W
$\eta$	Efficiency	50 % of max $I_O$		89.7		%
		max $I_O$		89.2		
		50 % of max $I_O$ , $V_I = 48$ V		89.9		
		max $I_O$ , $V_I = 48$ V		89.3		
$P_d$	Power Dissipation	max $I_O$		6.0	9.5	W
$P_{li}$	Input idling power	$I_O = 0$ A, $V_I = 53$ V		1.8		W
$P_{RC}$	Input standby power	$V_I = 53$ V (turned off with RC)		0.15		W
$f_s$	Switching frequency	0-100 % of max $I_O$	290	320	350	kHz

$V_{O1}$	Output voltage initial setting and accuracy	$T_{ref} = +25^{\circ}\text{C}$ , $V_I = 53$ V, max $I_O$	3.24	3.30	3.36	V
$V_O$	Output adjust range	See operating information and note 2	1.90		3.63	V
	Output voltage tolerance band	0-100 % of max $I_O$	3.20		3.40	V
	Idling voltage	$I_O = 0$ A	3.24		3.36	V
	Line regulation	max $I_O$		1	10	mV
	Load regulation	$V_I = 53$ V, 0-100 % of max $I_O$		8	18	mV
$V_{tr}$	Load transient voltage deviation	$V_I = 53$ V, Load step 25-75-25 % of max $I_O$ , $di/dt = 1$ A/ $\mu\text{s}$ .		-165/+150	-330/+250	mV
$t_{tr}$	Load transient recovery time			20	40	$\mu\text{s}$
$t_r$	Ramp-up time (from 10-90 % of $V_O$ )	0-100 % of max $I_O$	2.5	4	4.6	ms
$t_s$	Start-up time (from $V_I$ connection to 90 % of $V_O$ )		6	8	9	ms
$t_f$	$V_I$ shut-down fall time (from $V_I$ off to 10 % of $V_O$ )	max $I_O$	0.1	0.2	0.3	ms
		$I_O = 10$ % of max $I_O$	1.0	1.4	1.6	ms
$t_{RC}$	RC start-up time	max $I_O$		6		ms
	RC shut-down fall time (from RC off to 10 % of $V_O$ )	max $I_O$		1		ms
		$I_O = 10$ % of max $I_O$		1.5		ms
$I_O$	Output current		0		15	A
$I_{lim}$	Current limit threshold	$T_{ref} < \text{max } T_{ref}$	16	18	22	A
$I_{sc}$	Short circuit current	$T_{ref} = 25^{\circ}\text{C}$ , see Note 3		14		A
$V_{Oac}$	Output ripple & noise	See ripple & noise section, max $I_O$ , $V_{O1}$		60	100	mVp-p
OVP	Over voltage protection	$T_{ref} = +25^{\circ}\text{C}$ , $V_I = 53$ V, 0-100 % of max $I_O$		4.35		V

Note 1: See Operating Instruction, section Turn-off Input Voltage

Note 2:  $V_I$  min 38 V to obtain 3.63 V at 49.5 W output power.

Note 3: RMS current in hiccup mode,  $V_O$  lower than aprox 0.5 V.

PKU 4000 Series DC/DC converters, Input 36-75 V, Output 25 A/50 W	EN/LZT 146 308 R4B July 2008 © Ericsson Power Modules AB
--	---

**3.3 V/15 A Typical Characteristics**

**PKU 4510 PI**

**Efficiency**

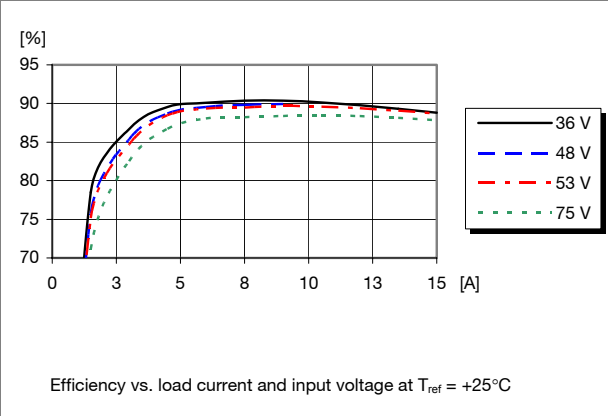

**Power Dissipation**

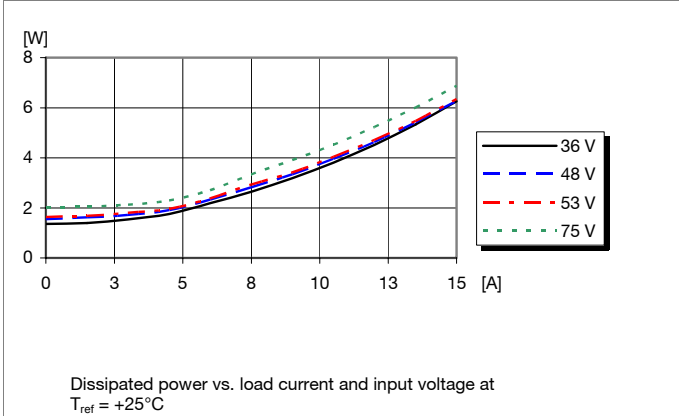

**Output Current Derating**

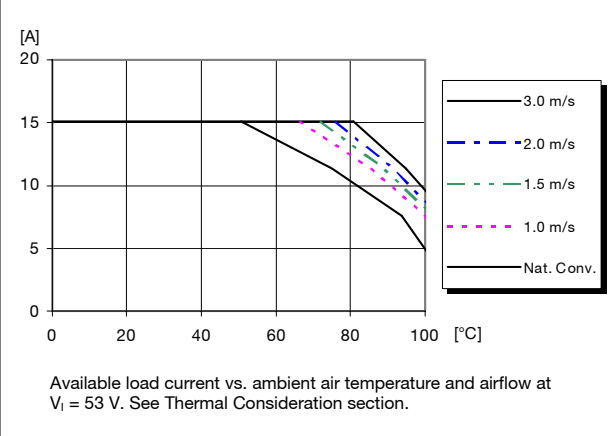

**Thermal Resistance**

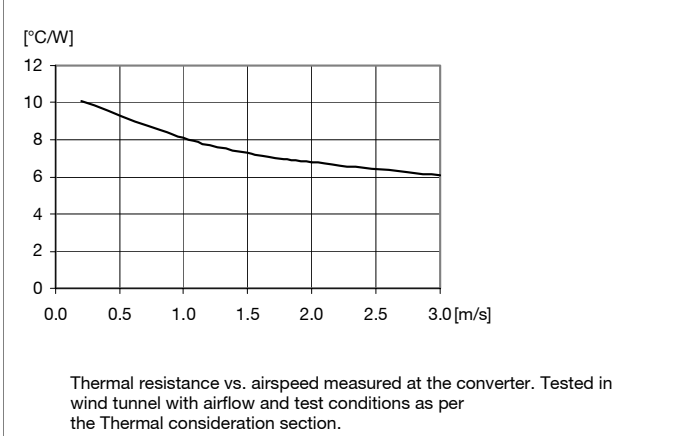

**Output Characteristics**

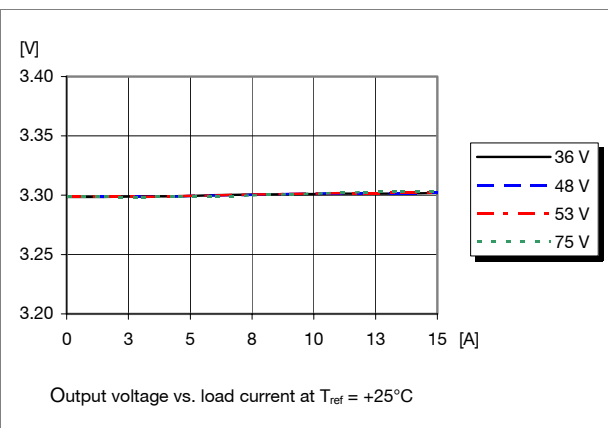

**Current Limit Characteristics**

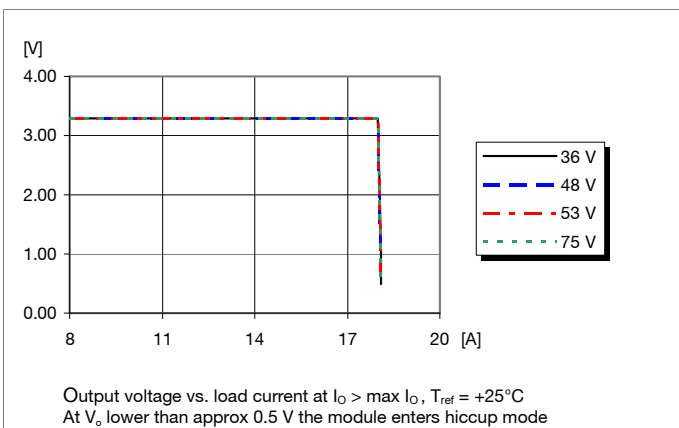

PKU 4000 Series DC/DC converters, Input 36-75 V, Output 25 A/50 W	EN/LZT 146 308 R4B July 2008 © Ericsson Power Modules AB
--	---

**3.3 V/15 A Typical Characteristics**

**PKU 4510 PI**

**Start-up**

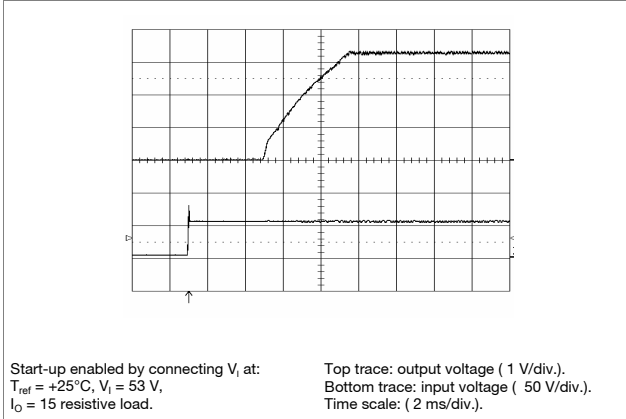

**Shut-down**

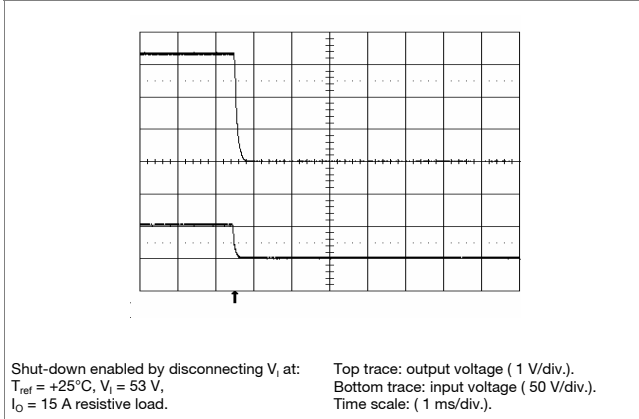

**Output Ripple & Noise**

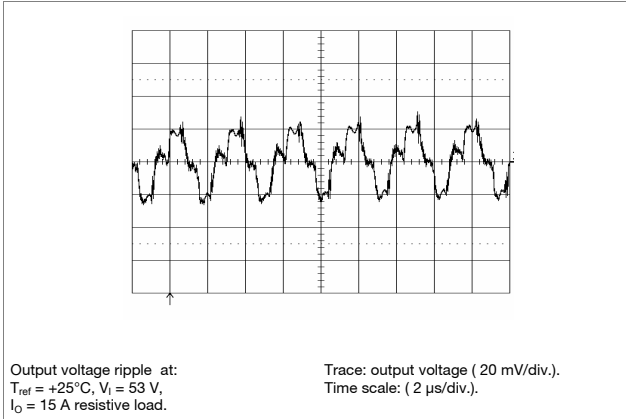

**Output Load Transient Response**

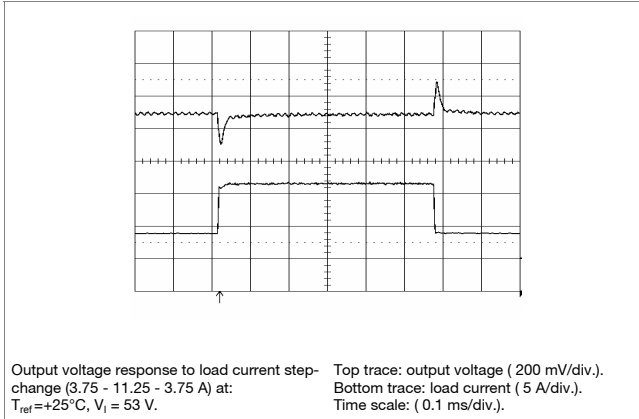

**Output Voltage Adjust (see operating information)**

**Passive adjust**

The resistor value for an adjusted output voltage is calculated by using the following equations:

Output Voltage Adjust Upwards, Increase:

$$R_{adj} = \left( \frac{5.11 \times 3.30(100 + \Delta\%)}{1.225 \times \Delta\%} - \frac{511}{\Delta\%} - 10.22 \right) \text{ k}\Omega$$

Example: Increase 4% =>  $V_{out} = 3.432\text{ Vdc}$

$$\left( \frac{5.11 \times 3.30(100 + 4)}{1.225 \times 4} - \frac{511}{4} - 10.22 \right) \text{ k}\Omega = 220\text{ k}\Omega$$

Output Voltage Adjust Downwards, Decrease:

$$R_{adj} = \left( \frac{511}{\Delta\%} \right) - 10.22\text{ k}\Omega$$

Example: Decrease 2% =>  $V_{out} = 3.234\text{ Vdc}$

$$\left( \frac{511}{2} \right) - 10.22\text{ k}\Omega = 245\text{ k}\Omega$$

**Active adjust**

The output voltage may be adjusted using a voltage applied to the  $V_{adj}$  pin. This voltage is calculated by using the following equation:

$$V_{adj} = \left( 1.225 + 2.45 \times \frac{V_{desired} - 3.30}{3.30} \right) \text{ V}$$

Example: Upwards => 3.50 V

$$\left( 1.225 + 2.45 \times \frac{3.50 - 3.30}{3.30} \right) \text{ V} = 1.37\text{ V}$$

Example: Downwards => 3.10 V

$$\left( 1.225 + 2.45 \times \frac{3.10 - 3.30}{3.30} \right) \text{ V} = 1.08\text{ V}$$

PKU 4000 Series DC/DC converters, Input 36-75 V, Output 25 A/50 W	EN/LZT 146 308 R4B July 2008
	© Ericsson Power Modules AB

**5.0 V/10 A Electrical Specification**
**PKU 4511 PI**

$T_{ref} = -30$  to  $+110^{\circ}\text{C}$ ,  $V_i = 36$  to  $75$  V, sense pins connected to output pins unless otherwise specified under Conditions.  
 Typical values given at:  $T_{ref} = +25^{\circ}\text{C}$ ,  $V_i = 53$  V, max  $I_o$ , unless otherwise specified under Conditions.  
 An external capacitor of  $1\ \mu\text{F}$  is used on the input during all measurements.

Characteristics		Conditions	min	typ	Max	Unit
$V_i$	Input voltage range		36		75	V
$V_{loff}$	Turn-off input voltage	Decreasing input voltage, see Note 1	29	31	33	V
$V_{lon}$	Turn-on input voltage	Increasing input voltage see Note 1	32	33	34.5	V
$C_i$	Internal input capacitance			0.5		$\mu\text{F}$
$P_o$	Output power	Output voltage initial setting	0		50	W
$\eta$	Efficiency	50 % of max $I_o$		89.8		%
		max $I_o$		89.6		
		50 % of max $I_o$ , $V_i = 48$ V		90.0		
		max $I_o$ , $V_i = 48$ V		89.8		
$P_d$	Power Dissipation	max $I_o$		5.8	8.5	W
$P_{li}$	Input idling power	$I_o = 0$		1.8		W
$P_{RC}$	Input standby power	(turned off with RC)		0.15		W
$f_s$	Switching frequency	0-100 % of max $I_o$	290	320	350	kHz

$V_{oi}$	Output voltage initial setting and accuracy	$T_{ref} = +25^{\circ}\text{C}$ , $V_i = 53$ V, max $I_o$	4.90	5.00	5.10	V
$V_o$	Output adjust range	See operating information and note 2	4.00		5.50	V
	Output voltage tolerance band	0-100 % of max $I_o$	4.85		5.15	V
	Idling voltage	$I_o = 0$ A	4.90		5.10	V
	Line regulation	max $I_o$		5	10	mV
	Load regulation	$V_i = 53$ V, 0-100 % of max $I_o$		15	22	mV
$V_{tr}$	Load transient voltage deviation	Load step 25-75-25 % of max $I_o$ , $di/dt = 1$ A/ $\mu\text{s}$ ,		$\pm 250$	$\pm 500$	mV
$t_{tr}$	Load transient recovery time			20	45	$\mu\text{s}$
$t_r$	Ramp-up time (from 10-90 % of $V_o$ )	0-100 % of max $I_o$	2	4.5	5.5	ms
$t_s$	Start-up time (from $V_i$ connection to 90% of $V_o$ )		6	8	10	ms
$t_f$	$V_i$ shutdown fall time (from $V_i$ off to 10 % of $V_o$ )	max $I_o$	0.1	0.2	0.3	ms
		$I_o = 10$ % of max $I_o$	1.0	1.2	1.4	ms
$t_{RC}$	RC start-up time	max $I_o$		5.5		ms
	RC shutdown fall time (from RC off to 10% of $V_o$ )	max $I_o$		0.8		ms
		$I_o = 10$ % of max $I_o$		1.1		ms
$I_o$	Output current		0		10	A
$I_{lim}$	Current limit threshold	$T_{ref} < \max T_{ref}$	10.5	13.2	15.4	A
$I_{sc}$	Short circuit current	$T_{ref} = 25^{\circ}\text{C}$ , see Note 3		8		A
$V_{Oac}$	Output ripple & noise	See ripple & noise section, max $I_o$ , $V_{oi}$		50	100	mVp-p
OVP	Over voltage protection	$T_{ref} = +25^{\circ}\text{C}$ , 0-100% of max $I_o$		6.1		V

Note 1: See Operating Instruction, section Turn-off Input Voltage

Note 2:  $V_i$  min 38 V to obtain 5.50 V at 50 W output power.

Note 3: RMS current in hiccup mode,  $V_o$  lower than approx 0.5 V.

PKU 4000 Series DC/DC converters, Input 36-75 V, Output 25 A/50 W	EN/LZT 146 308 R4B July 2008 © Ericsson Power Modules AB
--	---

**5.0 V/10 A Typical Characteristics**

**PKU 4511 PI**

**Efficiency**

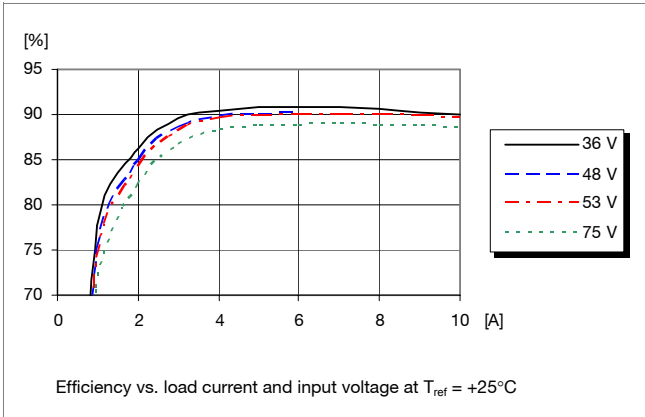

**Power Dissipation**

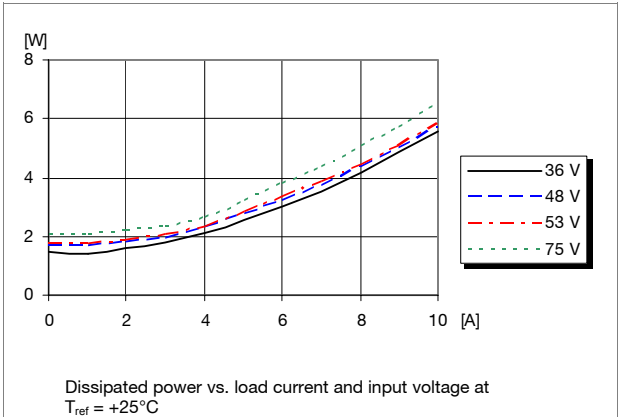

**Output Current Derating**

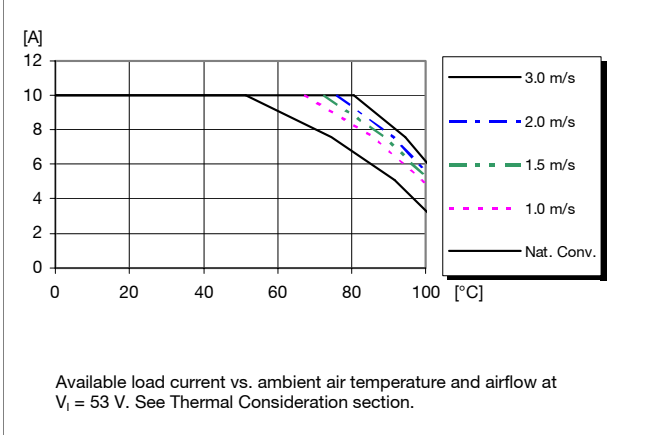

**Thermal Resistance**

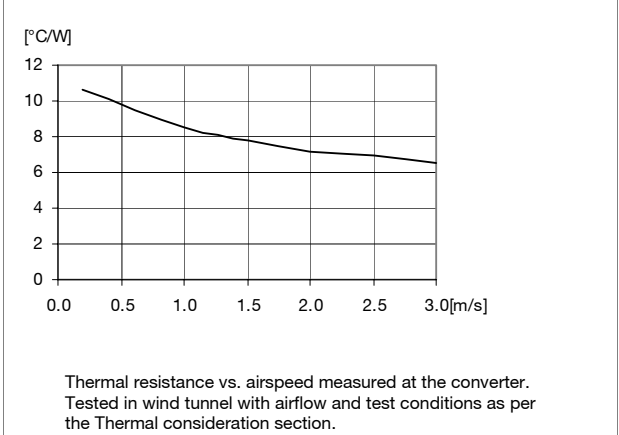

**Output Characteristics**

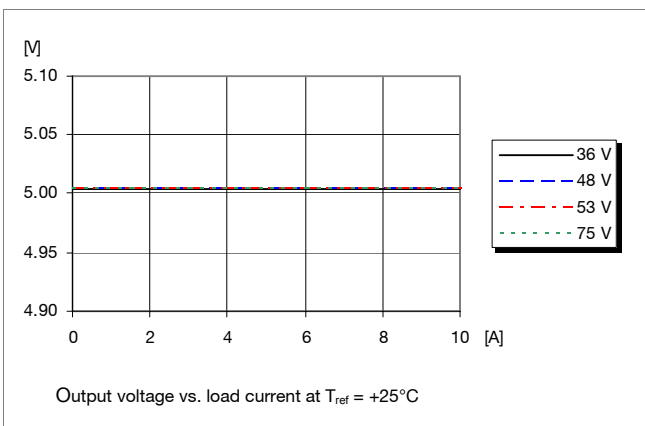

**Current Limit Characteristics**

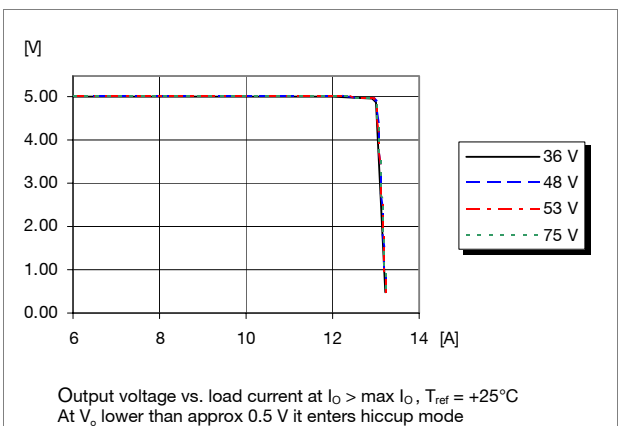

PKU 4000 Series  
DC/DC converters, Input 36-75 V, Output 25 A/50 W

EN/LZT 146 308 R4B July 2008  
© Ericsson Power Modules AB

**5.0 V/10 A Typical Characteristics**

**PKU 4511 PI**

**Start-up**

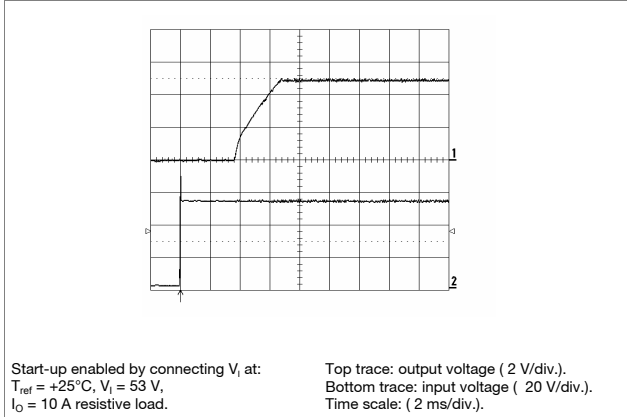

**Shut-down**

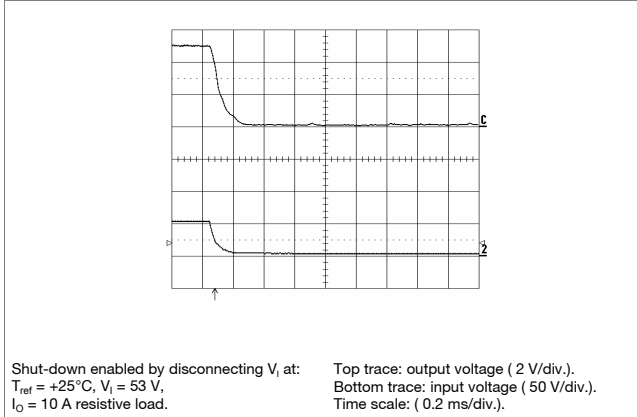

**Output Ripple & Noise**

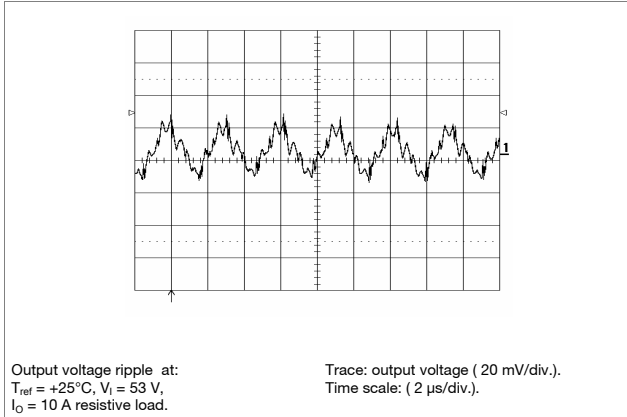

**Output Load Transient Response**

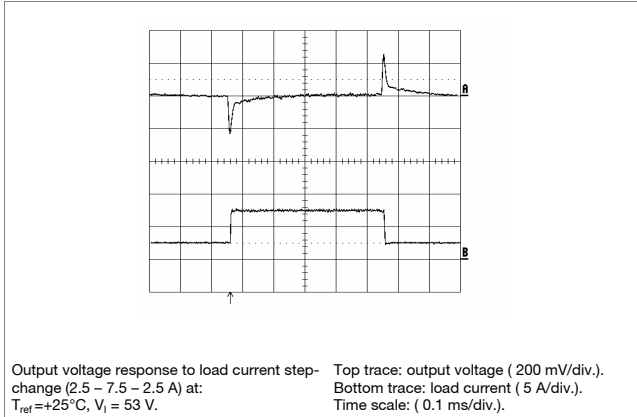

**Output Voltage Adjust (see operating information)**

**Passive adjust**

The resistor value for an adjusted output voltage is calculated by using the following equations:

Output Voltage Adjust Upwards, Increase:

$$R_{adj} = \left( \frac{5.11 \times 5.0(100 + \Delta\%)}{1.225 \times \Delta\%} - \frac{511}{\Delta\%} - 10.22 \right) \text{ k}\Omega$$

Example: Increase 3% =>  $V_{out} = 5.15\text{ Vdc}$

$$\left( \frac{5.11 \times 5.0(100 + 3)}{1.225 \times 3} - \frac{511}{3} - 10.22 \right) \text{ k}\Omega = 535 \text{ k}\Omega$$

Output Voltage Adjust Downwards, Decrease:

$$R_{adj} = \left( \frac{511}{\Delta\%} \right) - 10.22 \text{ k}\Omega$$

Example: Decrease 3% =>  $V_{out} = 4.85\text{ Vdc}$

$$\left( \frac{511}{3} \right) - 10.22 \text{ k}\Omega = 160 \text{ k}\Omega$$

**Active adjust**

The output voltage may be adjusted using a voltage applied to the  $V_{adj}$  pin. This voltage is calculated by using the following equation:

$$V_{adj} = \left( 1.225 + 2.45 \times \frac{V_{desired} - 5.00}{5.00} \right) \text{ V}$$

Example: Upwards => 5.30 V

$$\left( 1.225 + 2.45 \times \frac{5.30 - 5.00}{5.00} \right) \text{ V} = 1.372 \text{ V}$$

Example: Downwards => 4.80 V

$$\left( 1.225 + 2.45 \times \frac{4.80 - 5.00}{5.00} \right) \text{ V} = 1.127 \text{ V}$$

PKU 4000 Series DC/DC converters, Input 36-75 V, Output 25 A/50 W	EN/LZT 146 308 R4B July 2008
	© Ericsson Power Modules AB

**12 V/4.17 A Electrical Specification**
**PKU 4513 PI**

$T_{ref} = -30$  to  $+110^{\circ}\text{C}$ ,  $V_i = 36$  to  $75$  V, sense pins connected to output pins unless otherwise specified under Conditions.  
 Typical values given at:  $T_{ref} = +25^{\circ}\text{C}$ ,  $V_i = 53$  V, max  $I_o$ , unless otherwise specified under Conditions.  
 An external capacitor of  $1\ \mu\text{F}$  is used on the input during all measurements.

Characteristics		Conditions	min	typ	Max	Unit
$V_i$	Input voltage range		36		75	V
$V_{loff}$	Turn-off input voltage	Decreasing input voltage see Note 1	29	31	33	V
$V_{lon}$	Turn-on input voltage	Increasing input voltage see Note 1	32	33	33.5	V
$C_i$	Internal input capacitance			0.5		$\mu\text{F}$
$P_o$	Output power	Output voltage initial setting	0		50	W
$\eta$	Efficiency	50 % of max $I_o$		88.5		%
		max $I_o$		89.0		
		50 % of max $I_o$ , $V_i = 48$ V		89.5		
		max $I_o$ , $V_i = 48$ V		89.5		
$P_d$	Power Dissipation	max $I_o$		6	9.5	W
$P_{li}$	Input idling power	$I_o = 0$ A		2		W
$P_{RC}$	Input standby power	(turned off with RC)		0.15		W
$f_s$	Switching frequency	0-100 % of max $I_o$	290	320	350	kHz

$V_{oi}$	Output voltage initial setting and accuracy	$T_{ref} = +25^{\circ}\text{C}$ , $V_i = 53$ V, max $I_o$	11.76	12.00	12.24	V
$V_o$	Output adjust range	See operating information and note 2	9.60		13.20	V
	Output voltage tolerance band	0-100 % of max $I_o$	11.64		12.36	V
	Idling voltage	$I_o = 0$ A	11.70		12.30	V
	Line regulation	max $I_o$		20	50	mV
	Load regulation	$V_i = 53$ V, 0-100 % of max $I_o$		20	50	mV
$V_{tr}$	Load transient voltage deviation	$V_i = 53$ V, Load step 25-75-25 % of max $I_o$ , $di/dt = 1$ A/ $\mu\text{s}$ ,		$\pm 500$	$\pm 1000$	mV
$t_{tr}$	Load transient recovery time			14	50	$\mu\text{s}$
$t_r$	Ramp-up time (from 10-90 % of $V_{oi}$ )	0-100 % of max $I_o$	8	11	17	ms
$t_s$	Start-up time (from $V_i$ connection to 90 % of $V_{oi}$ )		13	16	22	ms
$t_f$	$V_i$ shut-down fall time (from $V_i$ off to 10 % of $V_{oi}$ )	max $I_o$	0.1	0.2	0.3	ms
		$I_o = 10$ % of max $I_o$	2	2.5	3	ms
$t_{RC}$	RC start-up time	max $I_o$		14		ms
	RC shut-down fall time (from RC off to 10 % of $V_{oi}$ )	max $I_o$		0.2		ms
		$I_o = 10$ % of max $I_o$		2.5		ms
$I_o$	Output current		0		4.17	A
$I_{lim}$	Current limit threshold	$T_{ref} < \max T_{ref}$	4.4	5.3	6.5	A
$I_{sc}$	Short circuit current	see Note 3		4.2		A
$V_{Oac}$	Output ripple & noise	See ripple & noise section, max $I_o$ , $V_{oi}$		60	120	mVp-p
OVP	Over voltage protection	0-100 % of max $I_o$		15		V

Note 1: See Operating Instruction, section Turn-off Input Voltage

Note 2:  $V_i$  min 38 V to obtain 13.2 V at 50 W output power.

Note 3: RMS current in hiccup mode,  $V_o$  lower than approx 0.5 V.

PKU 4000 Series DC/DC converters, Input 36-75 V, Output 25 A/50 W	EN/LZT 146 308 R4B July 2008
	© Ericsson Power Modules AB

**12 V/4.17 A Typical Characteristics**

**PKU 4513 PI**

**Efficiency**

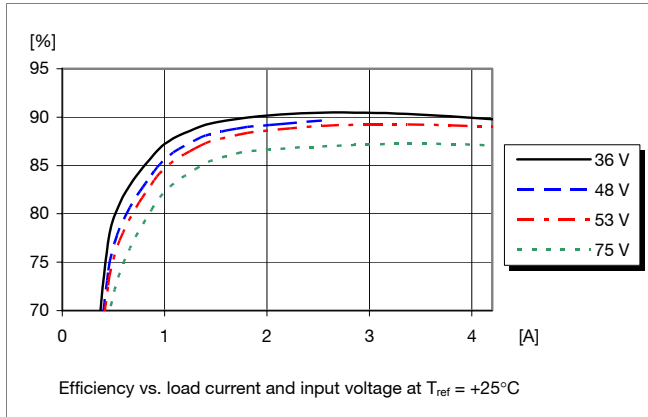

**Power Dissipation**

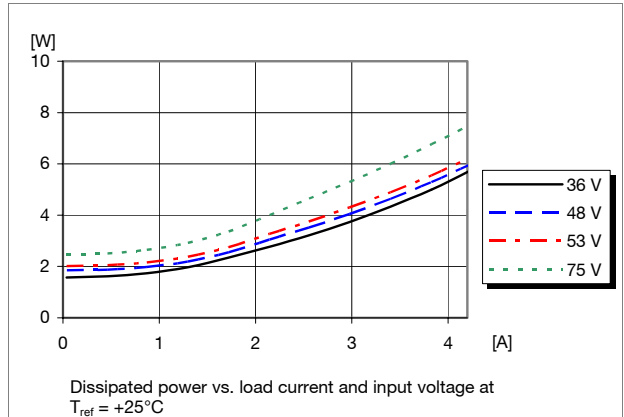

**Output Current Derating**

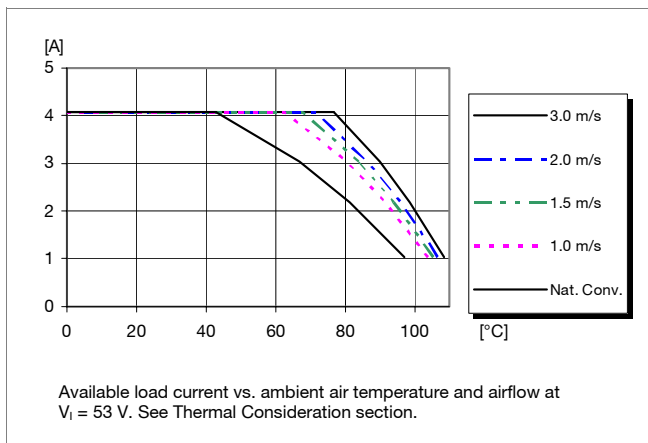

**Thermal Resistance**

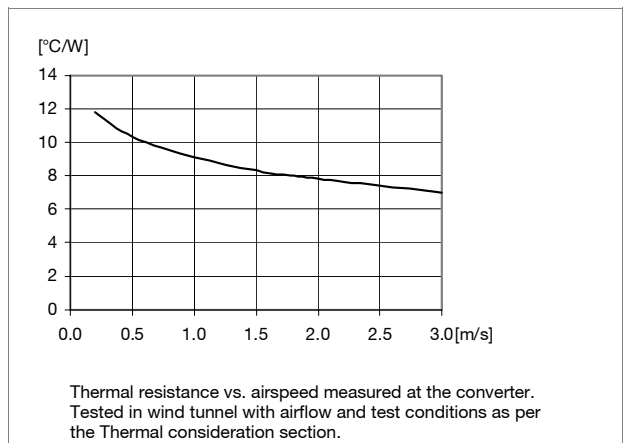

**Output Characteristics**

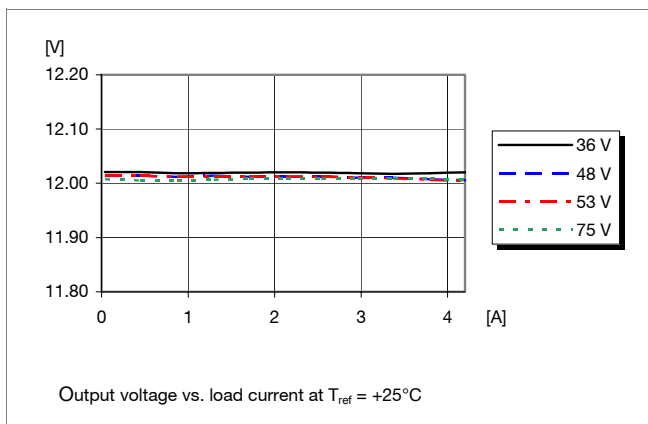

**Current Limit Characteristics**

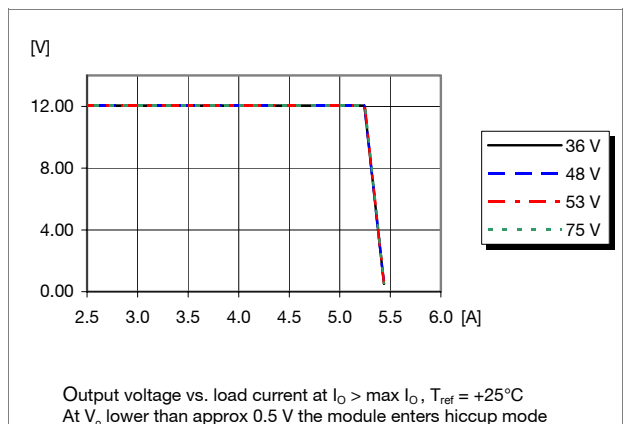



PKU 4000 Series DC/DC converters, Input 36-75 V, Output 25 A/50 W	EN/LZT 146 308 R4B July 2008 © Ericsson Power Modules AB
--	---

**12 V/4.17 A Typical Characteristics**

**PKU 4513 PI**

**Start-up**

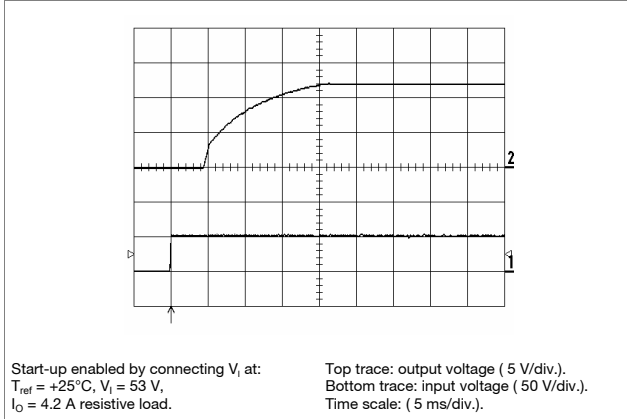

**Shut-down**

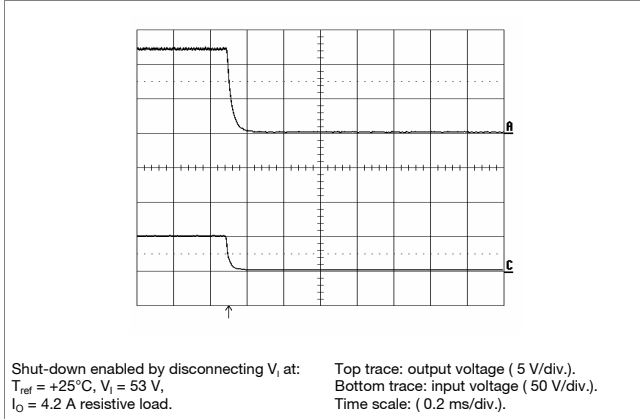

**Output Ripple & Noise**

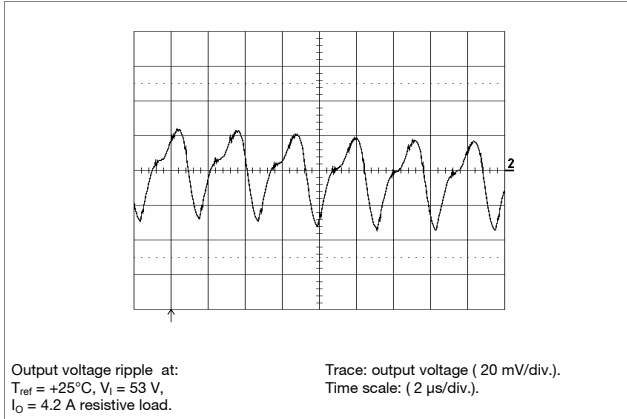

**Output Load Transient Response**

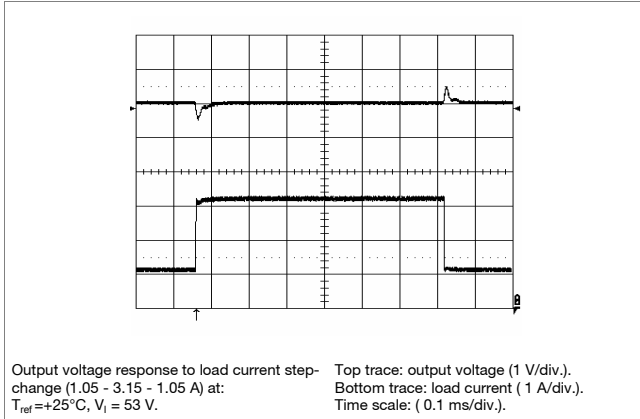

**Output Voltage Adjust (see operating information)**

**Passive adjust**

The resistor value for an adjusted output voltage is calculated by using the following equations:

Output Voltage Adjust Upwards, Increase:

$$R_{adj} = \left( \frac{5.11 \times 12.0(100 + \Delta\%)}{1.225 \times \Delta\%} - \frac{511}{\Delta\%} - 10.22 \right) \text{ k}\Omega$$

Example: Increase 4% =>  $V_{out} = 12.48\text{ V}$

$$\left( \frac{5.11 \times 12.0(100 + 4)}{1.225 \times 4} - \frac{511}{4} - 10.22 \right) \text{ k}\Omega = 1164 \text{ k}\Omega$$

Output Voltage Adjust Downwards, Decrease:

$$R_{adj} = \left( \frac{511}{\Delta\%} \right) - 10.22 \text{ k}\Omega$$

Example: Decrease 2% =>  $V_{out} = 11.76\text{ V}$

$$\left( \frac{511}{2} \right) - 10.22 \text{ k}\Omega = 245 \text{ k}\Omega$$

**Active adjust**

The output voltage may be adjusted using a voltage applied to the  $V_{adj}$  pin. This voltage is calculated by using the following equation:

$$V_{adj} = \left( 1.225 + 2.45 \times \frac{V_{desired} - 12.0}{12.0} \right) \text{ V}$$

Example: Upwards => 12.5 V

$$\left( 1.225 + 2.45 \times \frac{12.5 - 12.0}{12.0} \right) \text{ V} = 1.33 \text{ V}$$

Example: Downwards => 11.0 V

$$\left( 1.225 + 2.45 \times \frac{11.0 - 12.0}{12.0} \right) \text{ V} = 1.02 \text{ V}$$

PKU 4000 Series DC/DC converters, Input 36-75 V, Output 25 A/50 W	EN/LZT 146 308 R4B July 2008
	© Ericsson Power Modules AB

**15 V/3.3 A Electrical Specification**
**PKU 4515 PI**

$T_{ref} = -30$  to  $+110^{\circ}\text{C}$ ,  $V_I = 36$  to  $75$  V, sense pins connected to output pins unless otherwise specified under Conditions.  
 Typical values given at:  $T_{ref} = +25^{\circ}\text{C}$ ,  $V_I = 53$  V, max  $I_O$ , unless otherwise specified under Conditions.  
 An external capacitor of  $1\ \mu\text{F}$  is used on the input during all measurements.

Characteristics		Conditions	min	typ	Max	Unit
$V_I$	Input voltage range		36		75	V
$V_{loff}$	Turn-off input voltage	Decreasing input voltage See Note 1	27	28	29	V
$V_{lon}$	Turn-on input voltage	Increasing input voltage See Note 1	32	33	33.5	V
$C_I$	Internal input capacitance			0.5		$\mu\text{F}$
$P_O$	Output power	Output voltage initial setting	0		49.5	W
$\eta$	Efficiency	50 % of max $I_O$		89.5		%
		max $I_O$		88.7		
		50 % of max $I_O$ , $V_I = 48$ V		89.9		
		max $I_O$ , $V_I = 48$ V		88.8		
$P_d$	Power Dissipation	max $I_O$		6.3	9.5	W
$P_{li}$	Input idling power	$I_O = 0$ A		1.8		W
$P_{RC}$	Input standby power	(turned off with RC)		0.14		W
$f_s$	Switching frequency	0-100 % of max $I_O$	290	320	350	kHz

$V_{O1}$	Output voltage initial setting and accuracy	$T_{ref} = +25^{\circ}\text{C}$ , $V_I = 53$ V, max $I_O$	14.70	15.00	15.30	V
$V_O$	Output adjust range	See operating information	12.00		16.50	V
	Output voltage tolerance band	0-100 % of max $I_O$	14.55		15.45	V
	Idling voltage	$I_O = 0$ A	14.55		15.45	V
	Line regulation	max $I_O$		60	130	mV
	Load regulation	$V_I = 53$ V, 0-100 % of max $I_O$		12	50	mV
$V_{tr}$	Load transient voltage deviation	$V_I = 53$ V, Load step 25-75-25 % of max $I_O$ , $di/dt = 1$ A/ $\mu\text{s}$ , See note 3		$\pm 400$	$\pm 800$	mV
$t_{tr}$	Load transient recovery time	See note 3		30	60	$\mu\text{s}$
$t_r$	Ramp-up time (from 10-90 % of $V_{O1}$ )	0-100 % of max $I_O$	3	6	9	ms
$t_s$	Start-up time (from $V_I$ connection to 90 % of $V_{O1}$ )		8	12	16	ms
$t_f$	$V_I$ shut-down fall time (from $V_I$ off to 10 % of $V_{O1}$ )	max $I_O$	0.2	0.4	0.8	ms
		$I_O = 10$ % of max $I_O$	2.5	3	3.5	ms
$t_{RC}$	RC start-up time	max $I_O$		10		ms
	RC shut-down fall time (from RC off to 10 % of $V_{O1}$ )	max $I_O$		0.25		ms
		$I_O = 10$ % of max $I_O$		1.2		ms
$I_O$	Output current		0		3.3	A
$I_{lim}$	Current limit threshold	$T_{ref} < \max T_{ref}$	3.6	4.3	5	A
$I_{sc}$	Short circuit current	See Note 2		3.0		A
$V_{Oac}$	Output ripple & noise	See ripple & noise section, max $I_O$ , $V_{O1}$		65	130	mVp-p
OVP	Over voltage protection	0-100 % of max $I_O$		19		V

Note 1: See Operating information section Turn-off Input Voltage.

Note 2: RMS current in hiccup mode,  $V_O$  lower than approx 0.5 V.

Note 3: Measured with  $100\ \mu\text{F}$  tantalum (ESR approx 80 m $\Omega$ ) on the output

PKU 4000 Series DC/DC converters, Input 36-75 V, Output 25 A/50 W	EN/LZT 146 308 R4B July 2008 © Ericsson Power Modules AB
--	---

**15 V/3.3 A Typical Characteristics**

**PKU 4515 PI**

**Efficiency**

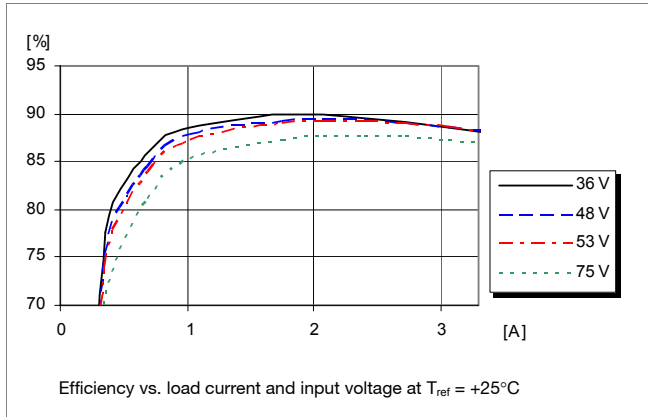

**Power Dissipation**

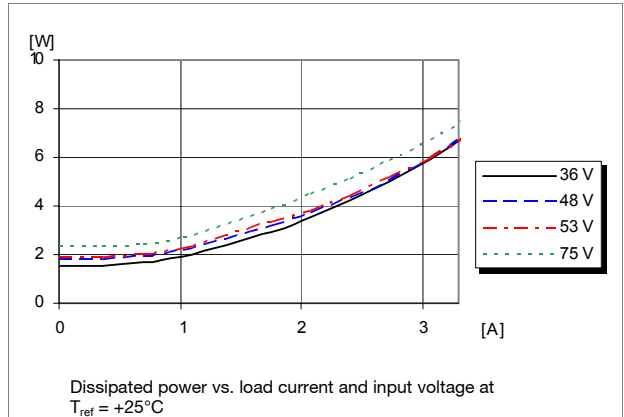

**Output Current Derating**

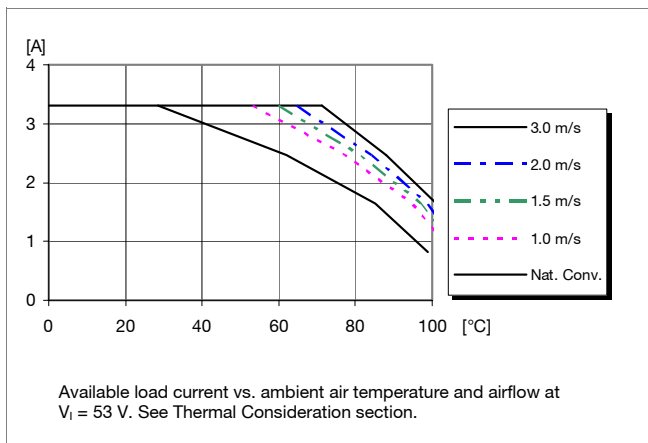

**Thermal Resistance**

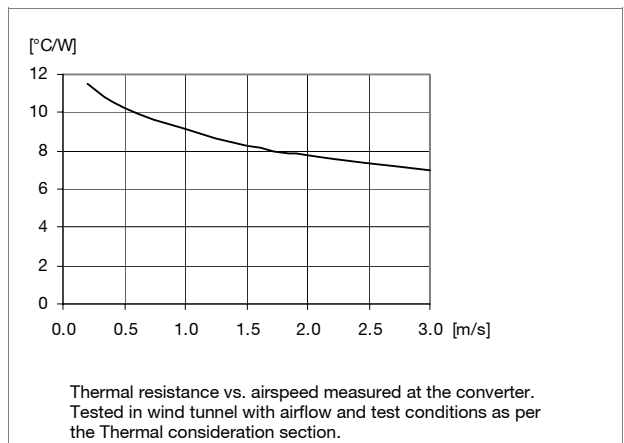

**Output Characteristics**

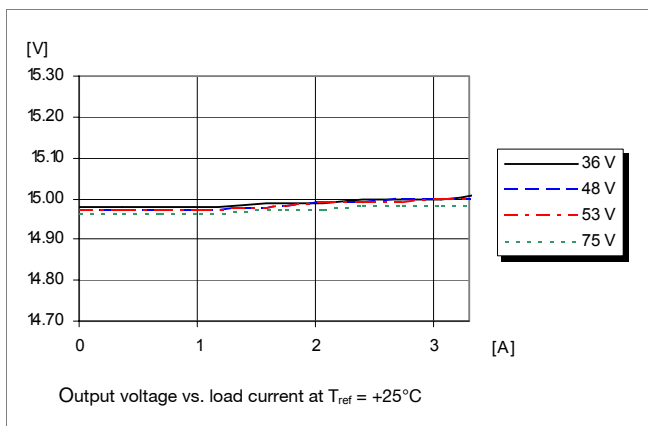

**Current Limit Characteristics**

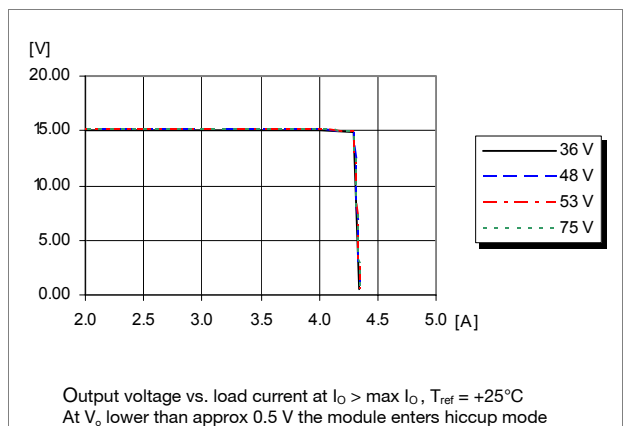

PKU 4000 Series DC/DC converters, Input 36-75 V, Output 25 A/50 W	EN/LZT 146 308 R4B July 2008
	© Ericsson Power Modules AB

**15V/3.3 A Typical Characteristics**

**PKU 4515 PI**

**Start-up**

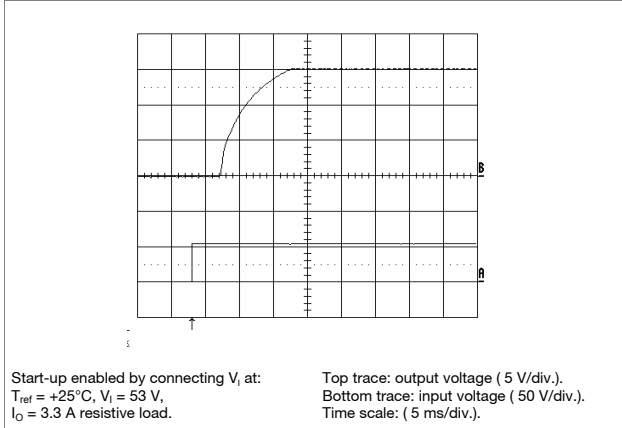

**Shut-down**

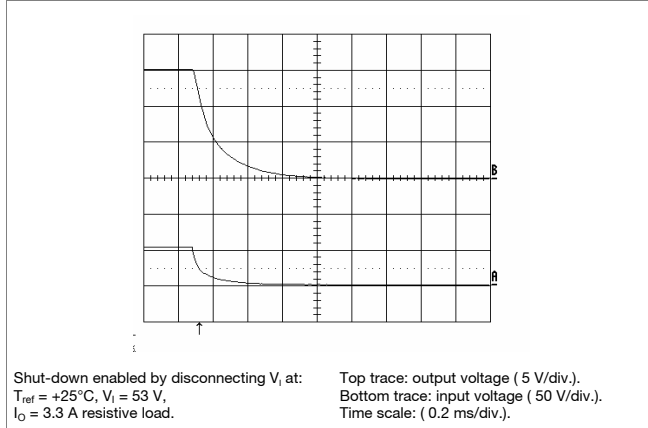

**Output Ripple & Noise**

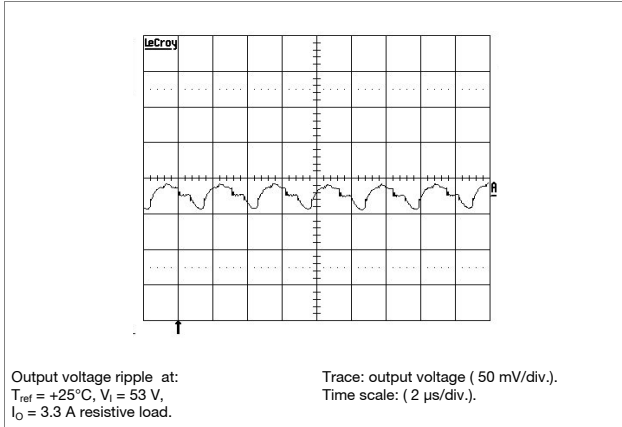

**Output Load Transient Response**

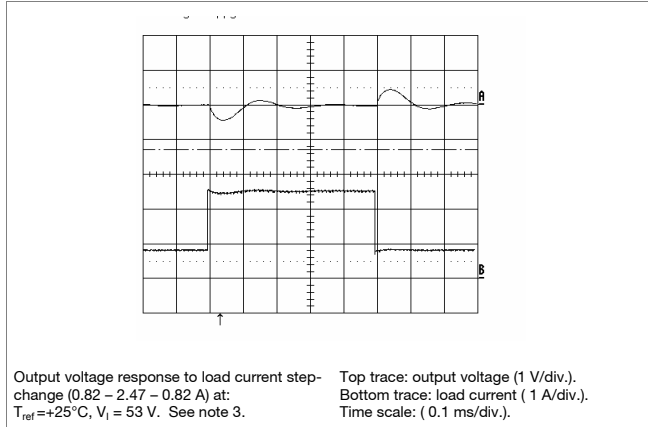

**Output Voltage Adjust (see operating information)**

**Passive adjust**

The resistor value for an adjusted output voltage is calculated by using the following equations:

Output Voltage Adjust Upwards, Increase:

$$R_{adj} = \left( \frac{5.11 \times 15.0(100 + \Delta\%)}{1.225 \times \Delta\%} - \frac{511}{\Delta\%} - 10.22 \right) \text{ k}\Omega$$

Example: Increase 4% =>  $V_{out} = 15.60\text{ V}$

$$\left( \frac{5.11 \times 15.0(100 + 4)}{1.225 \times 4} - \frac{511}{4} - 10.22 \right) \text{ k}\Omega = 1489 \text{ k}\Omega$$

Output Voltage Adjust Downwards, Decrease:

$$R_{adj} = \left( \frac{511}{\Delta\%} \right) - 10.22 \text{ k}\Omega$$

Example: Decrease 2% =>  $V_{out} = 14.70\text{ V}$

$$\left( \frac{511}{2} \right) - 10.22 \text{ k}\Omega = 245 \text{ k}\Omega$$

**Active adjust**

The output voltage may be adjusted using a voltage applied to the  $V_{adj}$  pin. This voltage is calculated by using the following equation:

$$V_{adj} = \left( 1.225 + 2.45 \times \frac{V_{desired} - 15.0}{15.0} \right) \text{ V}$$

Example: Upwards => 15.60 V

$$\left( 1.225 + 2.45 \times \frac{15.6 - 15.0}{15.0} \right) \text{ V} = 1.323 \text{ V}$$

Example: Downwards => 14.70 V

$$\left( 1.225 + 2.45 \times \frac{14.7 - 15.0}{15.0} \right) \text{ V} = 1.176 \text{ V}$$

PKU 4000 Series DC/DC converters, Input 36-75 V, Output 25 A/50 W	EN/LZT 146 308 R4B July 2008 © Ericsson Power Modules AB
--	---

**EMC Specification**

Conducted EMI measured according to EN55022, CISPR 22 and FCC part 15J (see test set-up). See Design Note 009 for further information. The fundamental switching frequency is 320 kHz for PKU 4511 PI @  $V_I = 53$  V, max  $I_O$ .

**Conducted EMI Input terminal value (typ)**

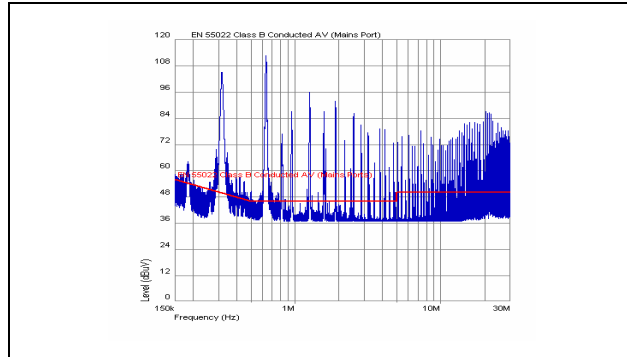

*EMI without filter*

**External filter (class B)**

Required external input filter in order to meet class B in EN 55022, CISPR 22 and FCC part 15J.

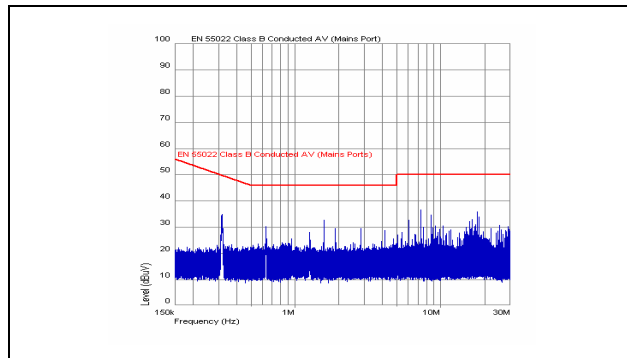
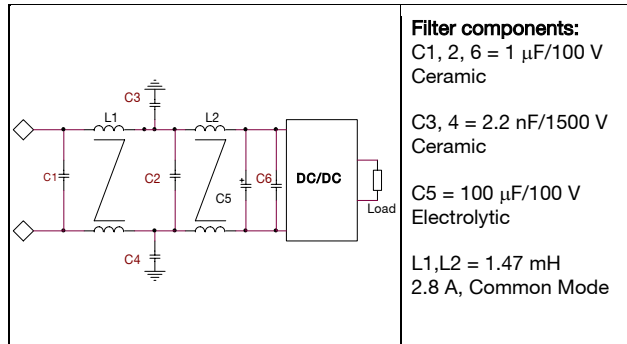

*EMI with filter*

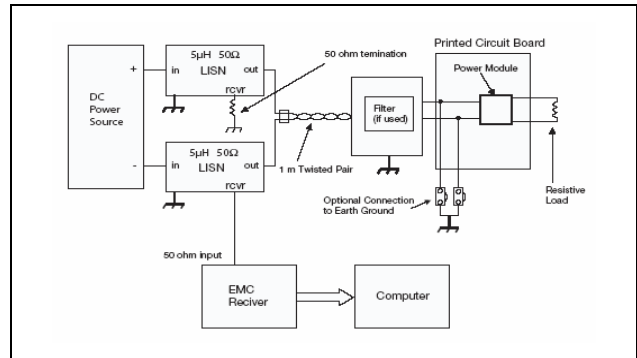

*Test set-up*

**Layout recommendation**

The radiated EMI performance of the DC/DC converter will depend on the PCB layout and ground layer design. It is also important to consider the stand-off of the DC/DC converter.

If a ground layer is used, it should be connected to the output of the DC/DC converter and the equipment ground or chassis.

A ground layer will increase the stray capacitance in the PCB and improve the high frequency EMC performance.

**Output ripple and noise**

Output ripple and noise measured according to figure below. See Design Note 022 for detailed information.

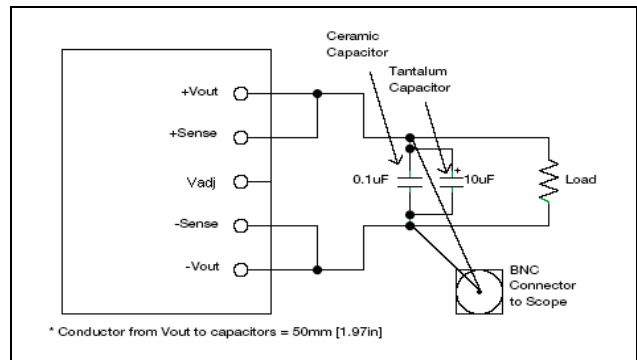

*Output ripple and noise test setup*

PKU 4000 Series DC/DC converters, Input 36-75 V, Output 25 A/50 W	EN/LZT 146 308 R4B July 2008
	© Ericsson Power Modules AB

## Operating information

### Input Voltage

The input voltage range 36 to 75 Vdc meets the requirements of the European Telecom Standard ETS 300 132-2 for normal input voltage range in -48 and -60 Vdc systems, -40.5 to -57.0 V and -50.0 to -72 V respectively.

At input voltages exceeding 75 V, the power loss will be higher than at normal input voltage and  $T_{ref}$  must be limited to absolute max +120°C. The absolute maximum continuous input voltage is 80 Vdc.

### Turn-off Input Voltage

The DC/DC converters monitor the input voltage and will turn on and turn off at predetermined levels.

The minimum hysteresis between turn on and turn off input voltage is 1 V. On the 15 V version the minimum hysteresis between turn on and turn off input voltage is 3 V.

### Remote Control (RC)

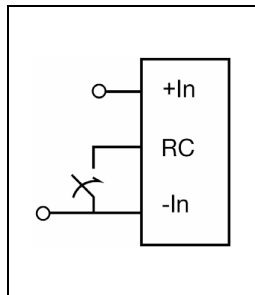

The products are fitted with a remote control function referenced to the primary negative input connection (- In), with negative and positive logic options available. The RC function allows the converter to be turned on/off by an external device like a semiconductor or mechanical switch. The RC pin has an internal pull up resistor to + In.

The maximum required sink current is 0.6 mA. When the RC pin is left open, the voltage generated on the RC pin is 10 – 22 V. The maximum allowable leakage current of the switch is 50  $\mu$ A. With “negative logic” the converter will turn on when the input voltage is applied with the RC connected to the - In. Turn off is achieved by leaving the RC pin open, or connected to a voltage higher than 8 V referenced to -In. The second option is “positive logic” remote control, which can be ordered by adding the suffix “P” to the end of the part number. The converter will turn on when the input voltage is applied with the RC pin open. Turn off is achieved by connecting the RC pin to the - In. To ensure safe turn off the voltage difference between RC pin and the - In pin shall be less than 1 V. The converter will restart automatically when this connection is opened.

See Design Note 021 for detailed information.

### Input and Output Impedance

The impedance of both the input source and the load will interact with the impedance of the DC/DC converter. It is important that the input source has low characteristic impedance. The converters are designed for stable operation without external capacitors connected to the output. It is recommended to use an external capacitor of minimum 1  $\mu$ F on the the input. The performance in some applications can

be enhanced by addition of external capacitance as described under External Decoupling Capacitors. If the input voltage source contains significant inductance, the addition of a 100  $\mu$ F capacitor across the input of the converter will ensure stable operation. The capacitor is not required when powering the DC/DC converter from an input source with an inductance below 10  $\mu$ H.

### External Decoupling Capacitors

When powering loads with significant dynamic current requirements, the voltage regulation at the point of load can be improved by addition of decoupling capacitors at the load. The most effective technique is to locate low ESR ceramic and electrolytic capacitors as close to the load as possible, using several parallel capacitors to lower the effective ESR. The ceramic capacitors will handle high-frequency dynamic load changes while the electrolytic capacitors are used to handle low frequency dynamic load changes. Ceramic capacitors will also reduce any high frequency noise at the load.

It is equally important to use low resistance and low inductance PCB layouts and cabling.

External decoupling capacitors will become part of the control loop of the DC/DC converter and may affect the stability margins. As a “rule of thumb”, 100  $\mu$ F/A of output current can be added without any additional analysis. The ESR of the capacitors is a very important parameter. Ericsson Power Modules guarantee stable operation with a verified ESR value of >10 m $\Omega$  across the output connections. For further information please contact your local Ericsson Power Modules representative.

PKU 4000 Series  
DC/DC converters, Input 36-75 V, Output 25 A/50 W

EN/LZT 146 308 R4B July 2008

© Ericsson Power Modules AB

## Operating information continued

### Output Voltage Adjust ( $V_{adj}$ )

The DC/DC converters have an Output Voltage Adjust pin ( $V_{adj}$ ). This pin can be used to adjust the output voltage above or below Output voltage initial setting.

When increasing the output voltage, the voltage at the output pins (including any remote sense compensation) must be kept below the threshold of the over voltage protection, (OVP) to prevent the converter from shutting down. At increased output voltages the maximum power rating of the converter remains the same, and the max output current must be decreased correspondingly.

To increase the voltage the resistor should be connected between the  $V_{adj}$  pin and +Sense pin. The resistor value of the Output voltage adjust function is according to information given under the Output section for the respective product. To decrease the output voltage, the resistor should be connected between the  $V_{adj}$  pin and -Sense pin.

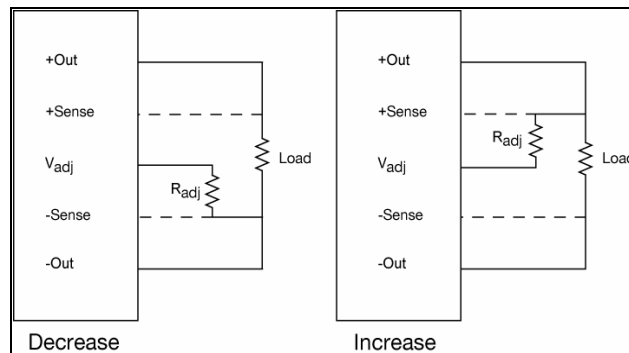

### Parallel Operation

Two converters may be paralleled for redundancy if the total power is equal or less than  $P_{O\ max}$ . It is not recommended to parallel the converters without using external current sharing circuits.

See Design Note 006 for detailed information.

### Remote Sense

The DC/DC converters have remote sense that can be used to compensate for voltage drops between the output and the point of load. The sense traces should be located close to the PCB ground layer to reduce noise susceptibility. The remote sense circuitry will compensate for up to 10% voltage drop between output pins and the point of load.

If the remote sense is not needed +Sense should be connected to +Out and -Sense should be connected to -Out.

### Over Temperature Protection (OTP)

The converters are protected from thermal overload by an internal over temperature shutdown circuit.

When  $T_{ref}$  as defined in thermal consideration section

exceeds 135°C the converter will shut down. The DC/DC converter will make continuous attempts to start up (non-latching mode) and resume normal operation automatically when the temperature has dropped >5°C below the temperature threshold.

### Over Voltage Protection (OVP)

The converters have output over voltage protection that will shut down the converter in over voltage conditions. The converter will make continuous attempts to start up (non-latching mode, hiccup) and resume normal operation automatically after removal of the over voltage condition.

### Over Current Protection (OCP)

The converters include current limiting circuitry for protection at continuous overload.

The output voltage will decrease towards zero for output currents in excess of max output current ( $I_{O\ max}$ ). If the output voltage decreases down to 0.5-0.6 V the converter shuts down and will make continuous attempts to start up (non-latching mode, hiccup). The converter will resume normal operation after removal of the overload. The load distribution should be designed for the maximum output short circuit current specified.

### Pre-bias Start-up

The product has a Pre-bias start up functionality and will not sink current during start up if a pre-bias source is present at the output terminals.

Typical Pre-bias source levels for no negative current:

- Up to 0.5 V for PKU 4318L (1.2 V)
- Up to 0.7 V for PKU 4318H (1.5 V)
- Up to 1.0 V for PKU 4418G (1.8 V)
- Up to 1.5 V for PKU 4319 (2.5 V)
- Up to 2.0 V for PKU 4510 (3.3 V)
- Up to 3.0 V for PKU 4511 (5 V)
- Up to 6.0 V for PKU 4513 (12 V)
- Up to 9.0 V for PKU 4515 (15 V)

PKU 4000 Series DC/DC converters, Input 36-75 V, Output 25 A/50 W	EN/LZT 146 308 R4B July 2008 © Ericsson Power Modules AB
--	---

**Thermal Consideration**

**General**

The converters are designed to operate in different thermal environments and sufficient cooling must be provided to ensure reliable operation. Cooling is achieved mainly by conduction, from the pins to the host board, and convection, which is dependent on the airflow across the converter. Increased airflow enhances the cooling of the converter.

The Output Current Derating graph found in the Output section for each model provides the available output current vs. ambient air temperature and air velocity at  $V_{in} = 53 V$ .

The DC/DC converter is tested on a 254 x 254 mm, 35  $\mu m$  (1 oz), 8-layer test board mounted vertically in a wind tunnel with a cross-section of 305 x 305 mm.

Proper cooling of the DC/DC converter can be verified by measuring the temperature at positions P1. The temperature at these positions should not exceed the max values provided in the table below.

See Design Note 019 for further information.

Position	Device	Designation	Max value
P <sub>1</sub>	Mosfet	T <sub>ref</sub>	120°C

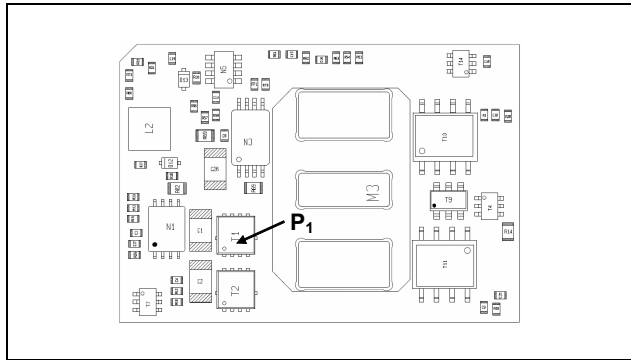

**Definition of reference temperature (T<sub>ref</sub>)**

The reference temperature is used to monitor the temperature limits of the product. Temperatures above maximum T<sub>ref</sub> are not allowed and may cause degradation or permanent damage to the product. T<sub>ref</sub> is also used to define the temperature range for normal operating conditions. T<sub>ref</sub> is defined by the design and used to guarantee safety margins, proper operation and high reliability of the module.

**Ambient Temperature Calculation**

By using the thermal resistance the maximum allowed ambient temperature can be calculated.

1. The power loss is calculated by using the formula  $((1/\eta) - 1) \times \text{output power} = \text{power losses (Pd)}$ .  
 $\eta = \text{efficiency of converter}$ . For example 89.2 % = 0.892

2. Find the thermal resistance (R<sub>th</sub>) in the Thermal Resistance graph found in the Output section for each model. Calculate the temperature increase ( $\Delta T$ ).

$$\Delta T = R_{th} \times P_d$$

3. Max allowed ambient temperature is:  
 Max T<sub>ref</sub> -  $\Delta T$ .

Example PKU 4510 (@ V<sub>i</sub> 53 V & 15 A) at 1 m/s:

1.  $((\frac{1}{0.892}) - 1) \times 49.5 W = 5.99 W$

2.  $5.99 W \times 9.2^\circ C/W = 55.1^\circ C$

3.  $120^\circ C - 55.1^\circ C = \text{max ambient temperature is } 64.9^\circ C$

The actual temperature will be dependent on several factors such as the PCB size, number of layers and direction of airflow.



PKU 4000 Series  
DC/DC converters, Input 36-75 V, Output 25 A/50 W

EN/LZT 146 308 R4B July 2008

© Ericsson Power Modules AB

**Connections**

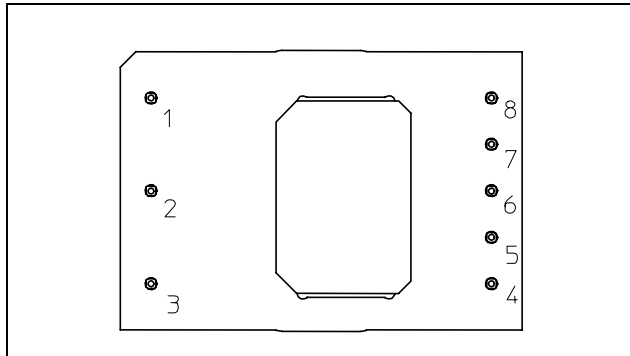

Top View

Pin	Designation	Function
1	+In	Positive Input
2	RC	Remote Control
3	-In	Negative Input
4	-Out	Negative Output
5	-Sen	Negative Sense
6	V <sub>adj</sub>	Output Voltage Adjust
7	+Sen	Positive Sense
8	+Out	Positive Output

PKU 4000 Series  
DC/DC converters, Input 36-75 V, Output 25 A/50 W

EN/LZT 146 308 R4B July 2008

© Ericsson Power Modules AB

**Mechanical Information - Hole Mount, Open Frame Version**

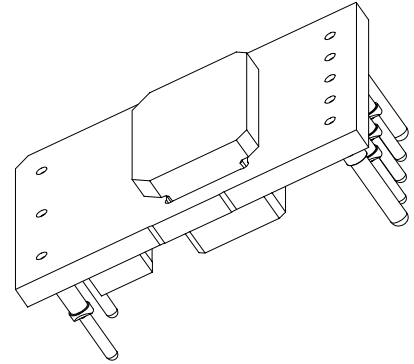
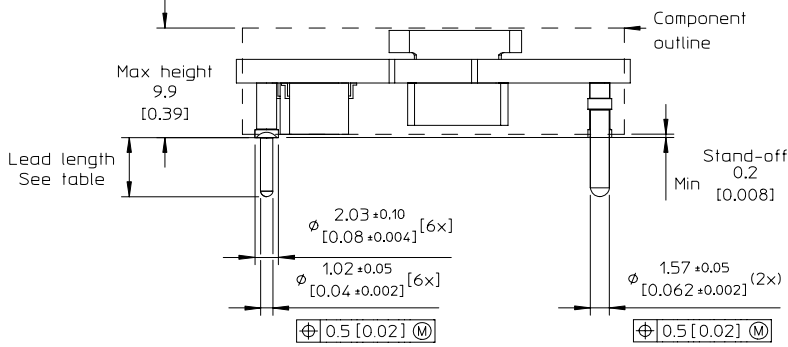

TOP VIEW  
Pin positions according to the recommended footprint

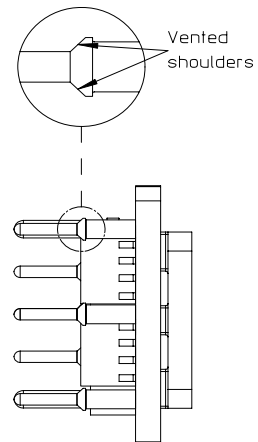
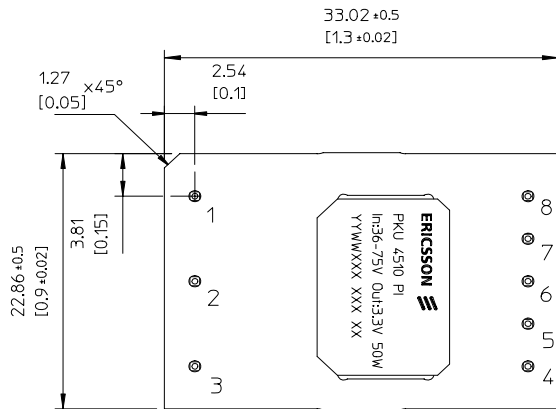

RECOMMENDED FOOTPRINT - TOP VIEW  
34.52 [1.36]

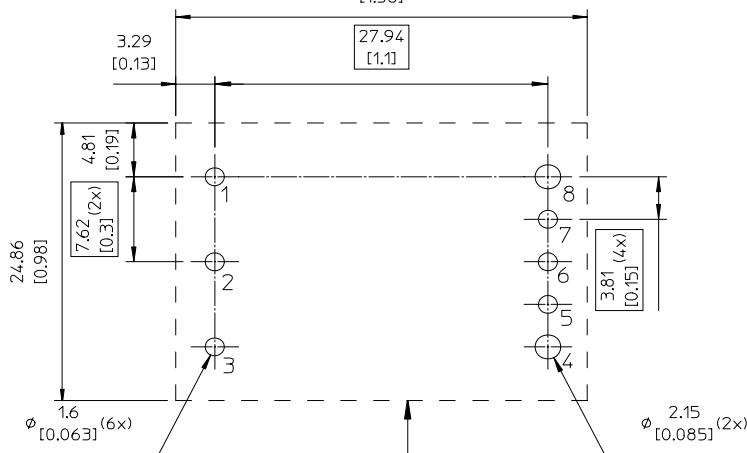

Pin option	Lead Length
Standard	5.30 [0.209]
LA	3.69 [0.145] (cut)
LB	4.57 [0.18] (cut)

Pins:  
Material: Copper alloy  
Plating: 0.1  $\mu$ m Gold over 2  $\mu$ m Nickel

Weight: Typical 13 g

All dimensions in mm [inch].  
Tolerances unless specified  
X.x mm  $\pm 0.5$  mm [ $\pm 0.02$ ],  
X.xx mm  $\pm 0.25$  mm [ $\pm 0.01$ ]  
(not applied on footprint or typical values)

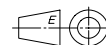

Recommended keep away area for user components. The stand-off, in combination with insulating material, ensures that requirements as per IEC/EN/UL60950 are met and 1500 V isolation maintained even if open vias or traces are present under the dc/dc-converter.

PKU 4000 Series  
DC/DC converters, Input 36-75 V, Output 25 A/50 W

EN/LZT 146 308 R4B July 2008

© Ericsson Power Modules AB

**Mechanical Information - Surface Mount Version**

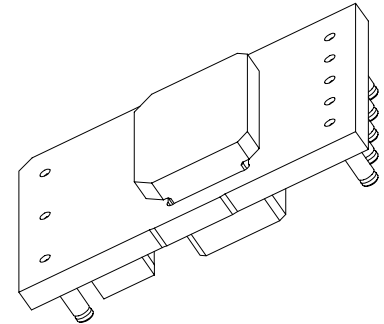
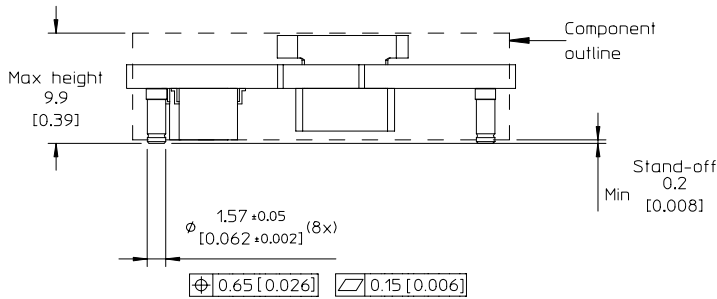

TOP VIEW  
Pin positions according to the recommended footprint

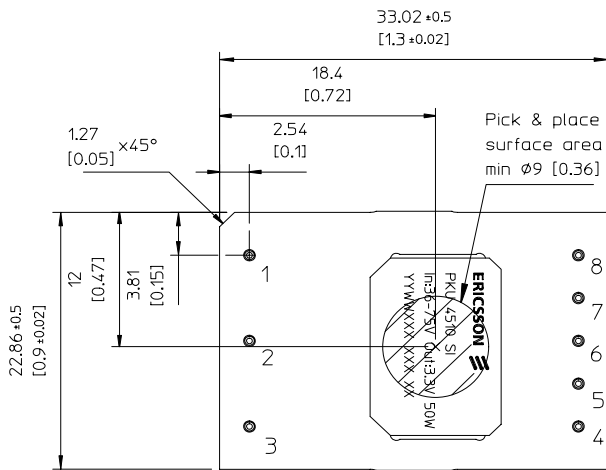

RECOMMENDED FOOTPRINT - TOP VIEW

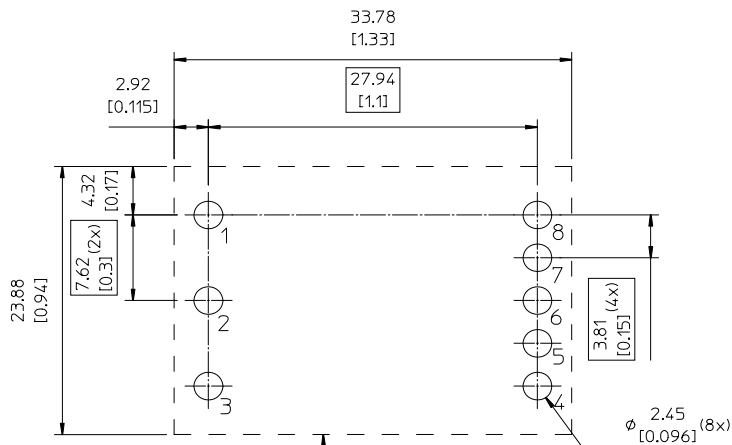

Recommended keep away area for user components. The stand-off, in combination with insulating material, ensures that requirements as per IEC/EN/UL60950 are met and 1500 V isolation maintained even if open vias or traces are present under the dc/dc-converter.

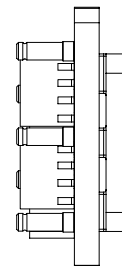

Layout considerations:  
Use sufficient numbers of vias connected to output pin pads for good thermal and current conductivity.

Pins:  
Material: Copper alloy  
Plating: 0.1 µm Gold over 2 µm Nickel

Weight: Typical 13 g

All dimensions are in mm [inch]  
Tolerances unless specified  
X.x mm ±0.5 mm [±0.02]  
X.xx mm ±0.25 mm [±0.01]  
(not applied on footprint or typical values)



PKU 4000 Series  
DC/DC converters, Input 36-75 V, Output 25 A/50 W

EN/LZT 146 308 R4B July 2008

© Ericsson Power Modules AB

**Soldering Information - Surface Mounting**

The surface mount product is intended for forced convection or vapor phase reflow soldering in SnPb or Pb-free processes.

The reflow profile should be optimised to avoid excessive heating of the product. It is recommended to have a sufficiently extended preheat time to ensure an even temperature across the host PCB and it is also recommended to minimize the time in reflow.

A no-clean flux is recommended to avoid entrapment of cleaning fluids in cavities inside the product or between the product and the host board, since cleaning residues may affect long time reliability and isolation voltage.

**Minimum Pin Temperature Recommendations**

Pin number 8 chosen as reference location for the minimum pin temperature recommendation since this will likely be the coolest solder joint during the reflow process.

**SnPb solder processes**

For SnPb solder processes, a pin temperature ( $T_{PIN}$ ) in excess of the solder melting temperature, ( $T_L$ , 183°C for Sn63Pb37) for more than 30 seconds and a peak temperature of 210°C is recommended to ensure a reliable solder joint.

For dry packed products only: depending on the type of solder paste and flux system used on the host board, up to a recommended maximum temperature of 245°C could be used, if the products are kept in a controlled environment (dry pack handling and storage) prior to assembly.

**Lead-free (Pb-free) solder processes**

For Pb-free solder processes, a pin temperature ( $T_{PIN}$ ) in excess of the solder melting temperature ( $T_L$ , 217 to 221°C for SnAgCu solder alloys) for more than 30 seconds and a peak temperature of 235°C on all solder joints is recommended to ensure a reliable solder joint.

**Maximum Product Temperature Requirements**

Top of the product PCB near pin 2 is chosen as reference location for the maximum (peak) allowed product temperature ( $T_{PRODUCT}$ ) since this will likely be the warmest part of the product during the reflow process.

**SnPb solder processes**

For SnPb solder processes, the product is qualified for MSL 1 according to IPC/JEDEC standard J-STD-020C.

During reflow  $T_{PRODUCT}$  must not exceed 225 °C at any time.

**Pb-free solder processes**

For Pb-free solder processes, the product is qualified for MSL 3 according to IPC/JEDEC standard J-STD-020C.

During reflow  $T_{PRODUCT}$  must not exceed 260 °C at any time.

**Dry Pack Information**

Surface mounted versions of the products are delivered in standard moisture barrier bags according to IPC/JEDEC standard J-STD-033 (Handling, packing, shipping and use of moisture/reflow sensitivity surface mount devices).

General reflow process specifications		SnPb eutectic	Pb-free
Average ramp-up ( $T_{PRODUCT}$ )		3°C/s max	3°C/s max
Typical solder melting (liquidus) temperature	$T_L$	183°C	221°C
Minimum reflow time above $T_L$		30 s	30 s
Minimum pin temperature	$T_{PIN}$	210°C	235°C
Peak product temperature	$T_{PRODUCT}$	225°C	260°C
Average ramp-down ( $T_{PRODUCT}$ )		6°C/s max	6°C/s max
Maximum time 25°C to peak		6 minutes	8 minutes

Using products in high temperature Pb-free soldering processes requires dry pack storage and handling. In case the products have been stored in an uncontrolled environment and no longer can be considered dry, the modules must be baked according to J-STD-033.

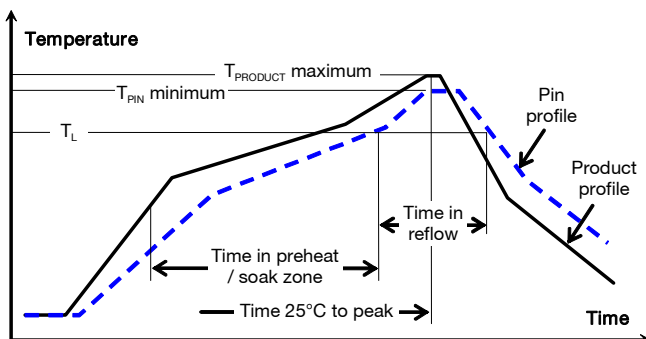

**Thermocoupler Attachment**

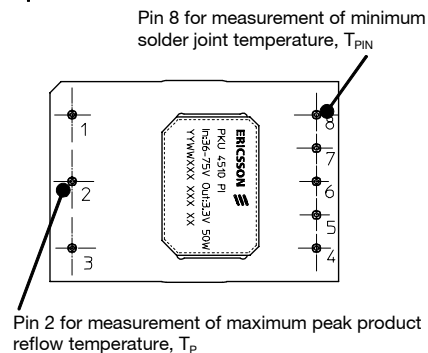

PKU 4000 Series DC/DC converters, Input 36-75 V, Output 25 A/50 W	EN/LZT 146 308 R4B July 2008
	© Ericsson Power Modules AB

**Soldering Information - Hole Mounting**

The hole mounted product is intended for plated through hole mounting by wave or manual soldering. The pin temperature is specified to maximum to 270°C for maximum 10 seconds.

A maximum preheat rate of 4°C/s and maximum preheat temperature of 150°C is suggested. When soldering by hand, care should be taken to avoid direct contact between the hot soldering iron tip and the pins for more than a few seconds in order to prevent overheating.

A no-clean flux is recommended to avoid entrapment of cleaning fluids in cavities inside the product or between the product and the host board. The cleaning residues may affect long time reliability and isolation voltage.

**Delivery Package Information**

The products are delivered in antistatic injection molded trays (Jedec design guide 4.10D standard) and the surface mount version also in antistatic carrier tape (EIA 481 standard).

Tray Specifications	
<b>Material</b>	PPE, antistatic
<b>Surface resistance</b>	$10^5 < \text{Ohm/square} < 10^{12}$
<b>Bakability</b>	The trays can be baked at maximum 125°C for 48 hours maximum
<b>Tray thickness</b>	20 mm, [0.787 inch]
<b>Box capacity</b>	150 products 5 full trays/box
<b>Tray weight</b>	520 g full tray, 130 g empty

Carrier Tape Specifications	
<b>Material</b>	PS, antistatic
<b>Surface resistance</b>	$< 10^7 \text{ Ohm/square}$
<b>Bakeability</b>	The tape is not bakable
<b>Tape width, W</b>	56 mm [2.2 inch]
<b>Pocket pitch, P<sub>1</sub></b>	36 mm [1.42 inch]
<b>Pocket depth, K<sub>0</sub></b>	11.4 mm [0.449 inch]
<b>Reel diameter</b>	380 mm [15 inch]
<b>Reel capacity</b>	200 products /reel
<b>Reel weight</b>	3 kg/full reel

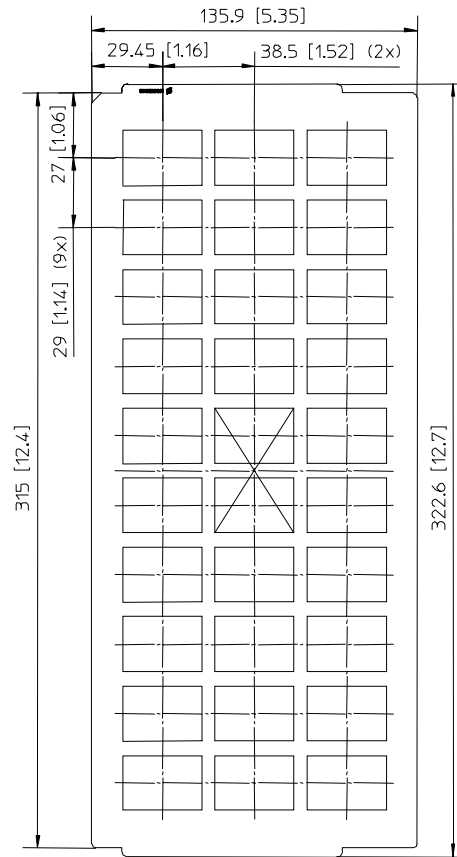
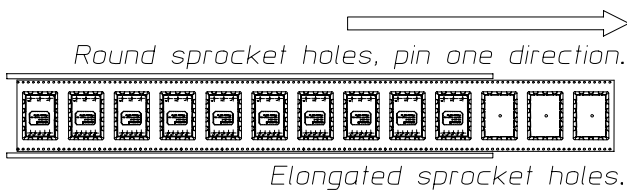

X = Vacuum pickup area.

PKU 4000 Series DC/DC converters, Input 36-75 V, Output 25 A/50 W	EN/LZT 146 308 R4B July 2008
	© Ericsson Power Modules AB

**Product Qualification Specification**

Characteristics			
External visual inspection	IPC-A-610		
Change of temperature (Temperature cycling)	IEC 60068-2-14 Na	Temperature range Number of cycles Dwell/transfer time	-40 to 100°C 1000 15 min/0-1 min
Cold (in operation)	IEC 60068-2-1 Ad	Temperature T <sub>A</sub> Duration	-45°C 72 h
Damp heat	IEC 60068-2-67 Cy	Temperature Humidity Duration	85°C 85 % RH 1000 hours
Dry heat	IEC 60068-2-2 Bd	Temperature Duration	125°C 1000 h
Electrostatic discharge susceptibility	IEC 61340-3-1, JESD 22-A114 IEC 61340-3-2, JESD 22-A115	Human body model (HBM) Machine Model (MM)	Class 2, 2000 V Class 3, 200 V
Immersion in cleaning solvents	IEC 60068-2-45 XA, method 2	Water Glycol ether Isopropyl alcohol	55°C 35°C 35°C
Mechanical shock	IEC 60068-2-27 Ea	Peak acceleration Duration	100 g 6 ms
Moisture reflow sensitivity <sup>1</sup>	J-STD-020C	Level 1 (SnPb-eutectic) Level 3 (Pb Free)	225°C 260°C
Operational life test	MIL-STD-202G, method 108A	Duration	1000 h
Resistance to soldering heat <sup>2</sup>	IEC 60068-2-20 Tb, method 1A	Solder temperature Duration	270°C 10-13 s
Robustness of terminations	IEC 60068-2-21 Test Ua1 IEC 60068-2-21 Test Ue1	Through hole mount products Surface mount products	All leads All leads
Solderability	IEC 60068-2-58 test Td <sup>1</sup>	Preconditioning Temperature, SnPb Eutectic Temperature, Pb-free	150°C dry bake 16 h 215°C 235°C
	IEC 60068-2-20 test Ta <sup>2</sup>	Preconditioning Temperature, SnPb Eutectic Temperature, Pb-free	Steam ageing 235°C 260°C
Vibration, broad band random	IEC 60068-2-64 Fh, method 1	Frequency Spectral density Duration	10 to 500 Hz 0.07 g <sup>2</sup> /Hz 10 min in each 3 perpendicular directions

**Notes**

<sup>1</sup> Only for products intended for reflow soldering (surface mount products)

<sup>2</sup> Only for products intended for wave soldering (plated through hole products)