

## Austin Lynx™ SIP Non-Isolated dc-dc Power Modules: 3.0 Vdc - 5.5 Vdc Input, 0.9 Vdc - 3.3 Vdc Output, 10 A

### RoHS Compliant



### Applications

- Distributed Power Architectures
- Wireless Networks
- Access and Optical Network Equipment
- Enterprise Networks
- Data processing Equipment
- Latest generation IC's (DSP, FPGA, ASIC) and Microprocessor-powered applications.

### Options

- Remote Sense
- Long Pins: 5.08 mm ± 0.25 mm  
(0.200 in ± 0.010 in)

### Description

Austin Lynx™ power modules are non-isolated dc-dc converters that can deliver 10 A of output current with full load efficiency of 95% at 3.3 V output. These open frame modules in SIP package enable designers to develop cost-and space efficient solutions. Standard features include remote ON/OFF, output voltage adjustment, overcurrent and overtemperature protection.

### Features

- Compatible with RoHS EU Directive 200295/EC (-Z Versions)
- Compatible in RoHS EU Directive 200295/EC with lead solder exemption (non -Z versions)
- Delivers up to 10A output current
- High efficiency: 95% at 3.3V full load
- Small size and low profile:  
50.8 mm x 8.10mm x 12.7mm  
(2.0 in x 0.32 in x 0.5 in)
- Light Weight 0.27 oz(7.5 g)
- Cost-efficient open frame design
- High reliability: MTBF > 10M hours at 25 °C
- Remote On/Off
- Output overcurrent protection with auto-restart
- Overtemperature protection
- Constant frequency (300 kHz, typical)
- Adjustable output voltage ± 10% of VO (-5% to + 10% for 0.9 V output)
- Single-In-Line (SIP) Package
- UL\* 60950 Recognized, CSA† C22.2 No. 60950-00 Certified, and VDE‡ 0805 (IEC60950, 3rd edition) Licensed

\* UL is a registered trademark of Underwriters Laboratories, Inc.

† CSA is a registered trademark of Canadian Standards Association.

‡ VDE is a trademark of Verband Deutscher Elektrotechniker e.V.

§ This product is intended for integration into end-use equipment. All the required procedures for CE marking of end-use equipment should be followed. (The CE mark is placed on selected products.)

\*\* ISO is a registered trademark of the International Organization of Standards

## Absolute Maximum Ratings

Stresses in excess of the absolute maximum ratings can cause permanent damage to the device. These are absolute stress ratings only, functional operation of the device is not implied at these or any other conditions in excess of those given in the operations sections of the data sheet. Exposure to absolute maximum ratings for extended periods can adversely affect the device reliability.

Parameter	Device	Symbol	Min	Max	Unit
Input Voltage: Continuous	All	VIN	0	6.5	Vdc
Operating Ambient Temperature	All	TA	-40	85	°C
Storage Temperature	All	Tstg	-55	125	°C

## Electrical Specifications

Unless otherwise indicated, specifications apply over all operating input voltage, resistive load, and temperature conditions.

Parameter	Device	Symbol	Min	Typ	Max	Unit
Operating Input Voltage	AXH010A0S0R9	VIN	3.0		5.5	Vdc
	AXH010A0S1R0	VIN	3.0		5.5	Vdc
	AXH010A0P	VIN	3.0		5.5	Vdc
	AXH010A0M	VIN	3.0		5.5	Vdc
	AXH010A0Y	VIN	3.0		5.5	Vdc
	AXH010A0D	VIN	3.0		5.5	Vdc
	AXH010A0G	VIN	3.0		5.5	Vdc
	AXH010A0F	VIN	4.5		5.5	Vdc
Maximum Input Current (VI = 0 to VI,max; IO = IO,max)		II,max			9.5	A
Input Reflected-Ripple Current (5 Hz to 20 MHz; 1 μH source impedance; TA = 25 °C; CIN = 200 μF)				30		mAp-p
Input Ripple Rejection (100 - 120Hz)				40		dB

**CAUTION: This power module is not internally fused. An input line fuse must always be used.**

To preserve maximum flexibility, internal fusing is not included; however, to achieve maximum safety and system protection, always use an input line fuse. The safety agencies require a time-delay fuse with a maximum rating of 20A.

## Electrical Specifications (continued)

Parameter	Device	Symbol	Min	Typ	Max	Unit
Output Voltage Set Point (VI = 5V; IO = IO,max; TA = 25 °C)	AXH010A0S0R9	VO,set	0.886	0.9	0.914	Vdc
	AXH010A0S1R0	VO,set	0.985	1.0	1.015	Vdc
	AXH010A0P	VO,set	1.182	1.2	1.218	Vdc
	AXH010A0M	VO,set	1.47	1.5	1.53	Vdc
	AXH010A0Y	VO,set	1.764	1.8	1.836	Vdc
	AXH010A0D	VO,set	1.97	2.0	2.03	Vdc
	AXH010A0G	VO,set	2.45	2.5	2.55	Vdc
	AXH010A0F	VO,set	3.234	3.3	3.366	Vdc
Output Voltage (Over all operating input voltage, resistive load, and temperature conditions at steady state until end of life.)	AXH010A0S0R9	VO	0.873	—	0.927	Vdc
	AXH010A0S1R0	VO	0.970	—	1.03	Vdc
	AXH010A0P	VO	1.164	—	1.236	Vdc
	AXH010A0M	VO	1.455	—	1.545	Vdc
	AXH010A0Y	VO	1.746	—	1.854	Vdc
	AXH010A0D	VO	1.94	—	2.06	Vdc
	AXH010A0G	VO	2.425	—	2.575	Vdc
	AXH010A0F	VO	3.2	—	3.4	Vdc
Output Regulation: Line (VI = VI, min to VI, max) Load (IO = IO, min to IO, max) Temperature (TA = TA, min to TA, max)	All	—	—	0.2	—	%VO, set
	All	—	—	0.4	—	%VO, set
	All	—	—	0.5	—	%VO, set
Output Ripple and Noise Measured across 10µF Tantalum, 1µF Ceramic, RMS (5 Hz to 20 MHz bandwidth) Peak-to-peak (5 Hz to 20 MHz bandwidth)	All	—	—	7	15	mVrms
	All	—	—	25	30	mVp-p
Output Current	All	IO	—	—	10	A
Output Current-limit Inception (VO = 90% of VO, set)	All	IO	—	17	—	A
Output Short-circuit Current (Average) VO = 0.25 V	All	IO	—	3	—	A
Efficiency (VI = VIN, nom; IO = IO, max), TA = 25 °C	AXH010A0S0R9	η	—	83	—	%
	AXH010A0S1R0	η	—	85	—	%
	AXH010A0P	η	—	86	—	%
	AXH010A0M	η	—	88	—	%
	AXH010A0Y	η	—	90	—	%
	AXH010A0D	η	—	91	—	%
	AXH010A0G	η	—	92	—	%
	AXH010A0F	η	—	95	—	%
Switching Frequency	All	fsw	—	300	—	kHz

## General Specifications

Parameter	Min	Typ	Max	Unit
Calculated MTBF (IO = 100% of IO, max TA = 25 °C)	10,240,000			Hours
Weight	—	6.5(0.23)	7.5(0.27)	g (oz.)

## Feature Specifications

Unless otherwise indicated, specifications apply over all operating input voltage, resistive load, and temperature conditions. See Feature Descriptions for additional information.

Parameter	Device	Symbol	Min	Typ	Max	Unit
Remote On/Off Signal Interface (VI = VI,min to VI, max; open collector pnp or Compatible, Von/off signal referenced to GND. See Figure 20 and Feature Descriptions section)						
Logic Low (ON/OFF pin open—Module On) Ion/off = 0.0 μA Von/off = 0.3 V	All	Von/off	-0.7		0.3	V
Logic High (VON/OFF > 2.5 V)—Module Off Ion/off = 1 mA Von/off = 5.5 V	All	Ion/off			10	μA
Turn-on Time (IO = 80% of IO, max; VO within ±1% of steady state; see Figure 12)	All	Von/off			6.5	V
	All	Ion/off		5	1	mA
	All	—				ms
Output voltage set-point adjustment range (TRIM)	AXH010A0S0R9	Vtrim	-5		+10	%VO, set
	All	Vtrim	-10		+10	%VO, set
Overtemperature Protection (shutdown)	All	TQ1/TQ2	—	110	—	°C
Input Undervoltage Lockout						
Turn-on Threshold	All		2.63	2.8	2.95	V
Turn-off Threshold	All		2.47	2.7	2.9	V

## Characteristic Curves

The following figures provide typical characteristics curves (TA = 25 °C).

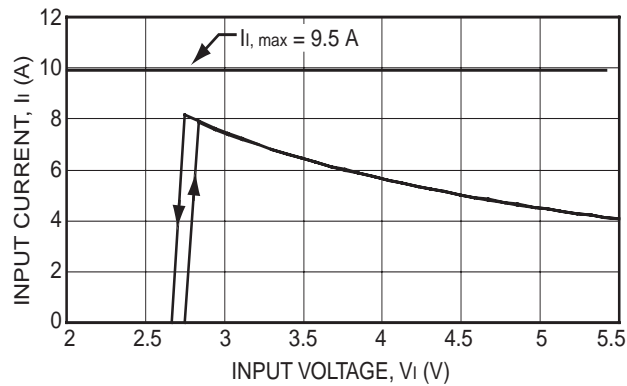


Figure 1. Input Voltage and Current Characteristics at 10A output current.

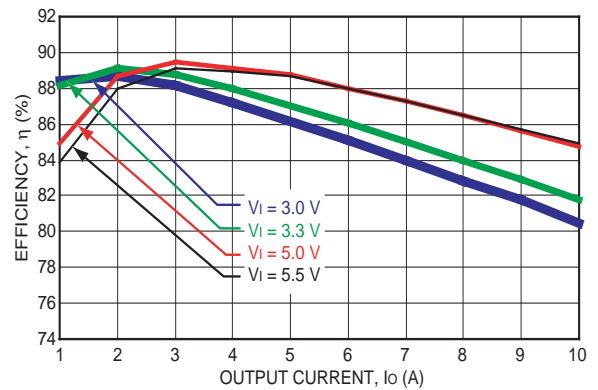


Figure 4. Converter Efficiency vs Output Current AXH010A0S1R0 (1.0V Output Voltage).

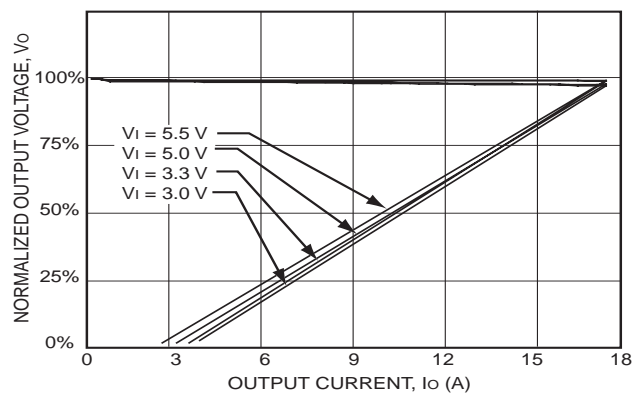


Figure 2. Output Voltage and current characteristics.

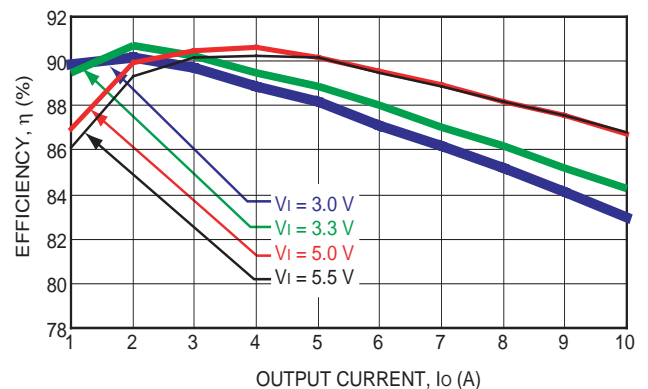


Figure 5. Converter Efficiency vs Output Current AXH010A0P (1.2V Output Voltage).

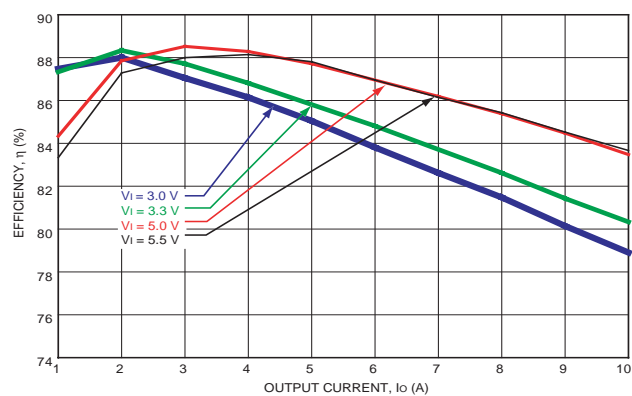


Figure 3. Converter Efficiency vs Output Current AXH010A0S0R9 (0.9V Output voltage).

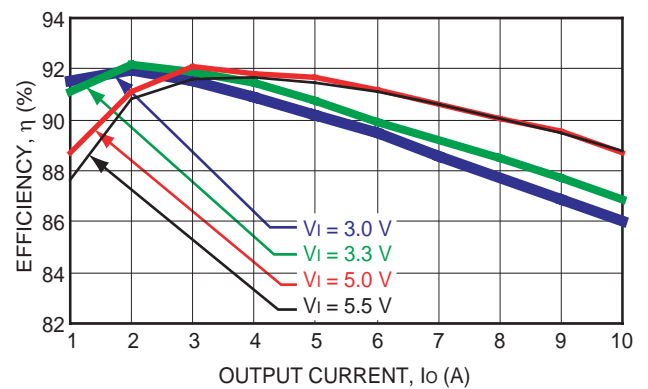


Figure 6. Converter Efficiency vs Output Current AXH010A0M (1.5V Output Voltage).

## Characteristic Curves

The following figures provide typical characteristics curves at room temperature ( $T_A = 25\text{ }^\circ\text{C}$ )

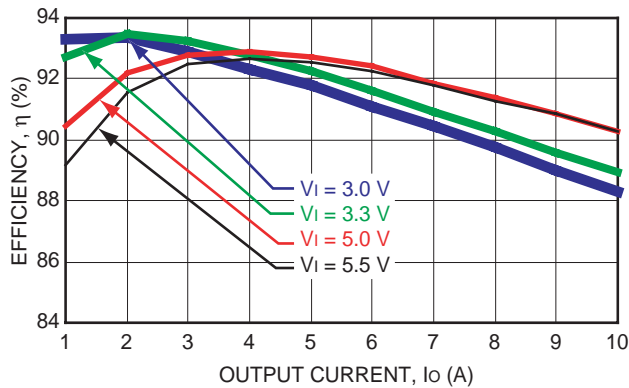


Figure 7. Converter Efficiency vs Output Current AXH010A0Y (1.8V Output Voltage).

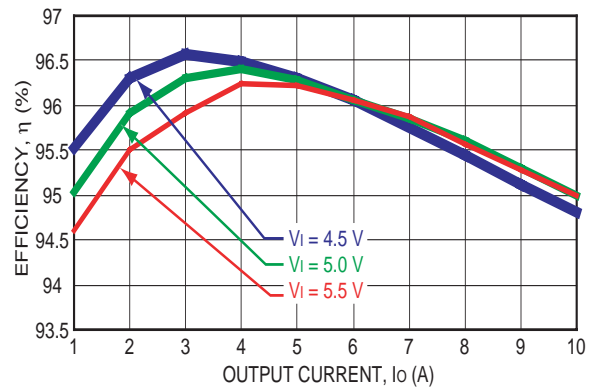


Figure 10. Converter Efficiency vs Output Current AXH010A0F (3.3V Output Voltage).

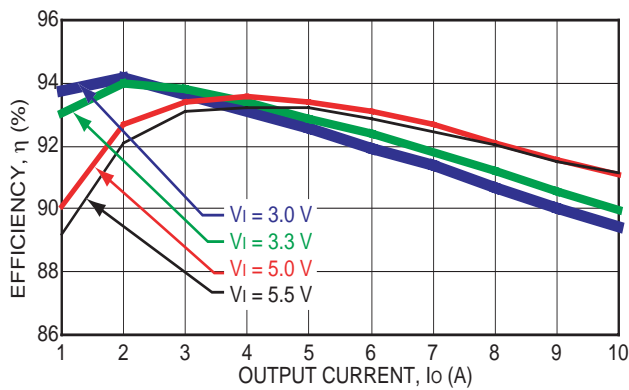


Figure 8. Converter Efficiency vs Output Current AXH010A0D (2.0V Output Voltage).

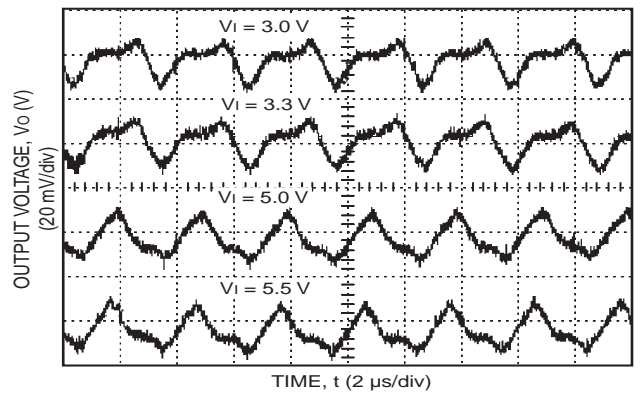


Figure 11. Typical Output Ripple Voltage at 10A Output Current.

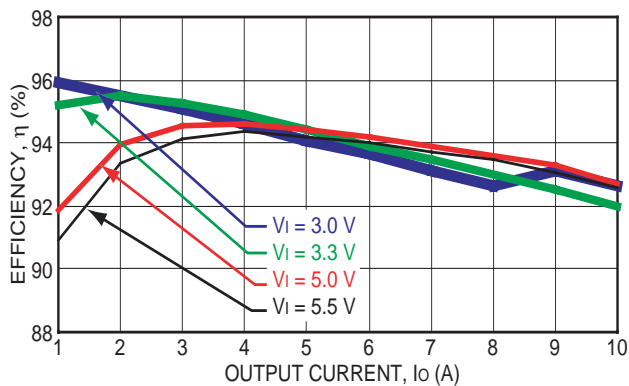


Figure 9. Converter Efficiency vs Output Current AXH010A0G (2.5V Output Voltage).

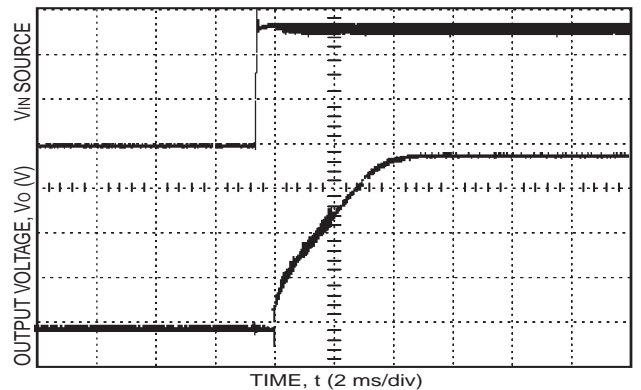
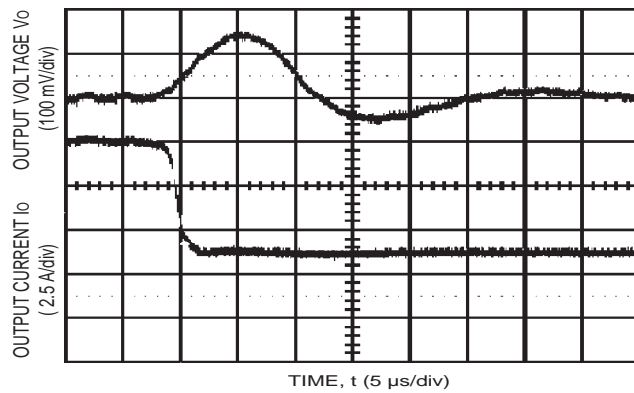


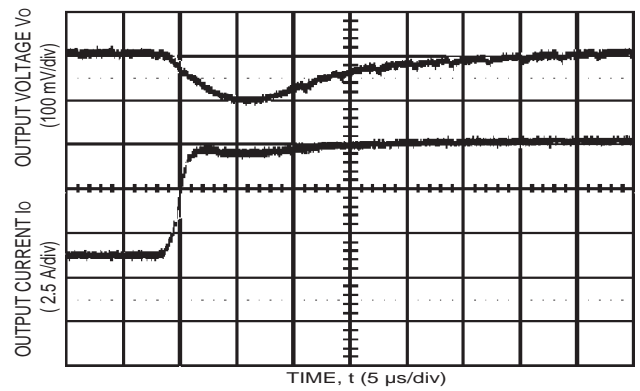
Figure 12. Typical Start-up Transient.

## Characteristic Curves

The following figures provide typical characteristics curves at room temperature ( $T_A = 25\text{ }^\circ\text{C}$ )

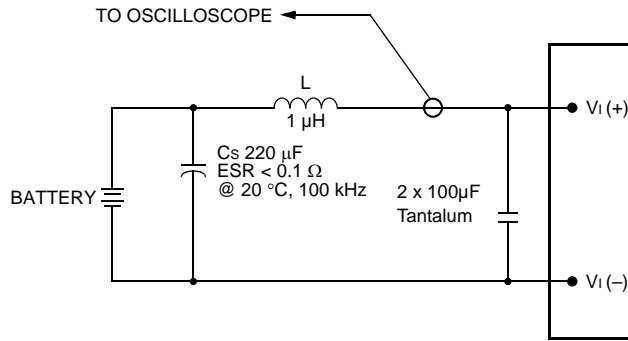


**Figure 13.** Typical Transient response to step load change at  $2.5\text{ A}/\mu\text{s}$  from 100% to 50% of  $I_{O,max}$  at 3.3 V Input ( $C_{out} = 1\text{ }\mu\text{F}$  ceramic,  $10\text{ }\mu\text{F}$  Tantalum).



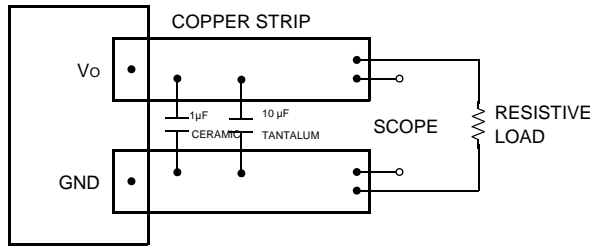
**Figure 14.** Typical Transient response to step load change at  $2.5\text{ A}/\mu\text{s}$  from 50% to 100% of  $I_{O,max}$  at 3.3 V Input ( $C_{out} = 1\text{ }\mu\text{F}$  ceramic,  $10\text{ }\mu\text{F}$  Tantalum).

## Test Configurations



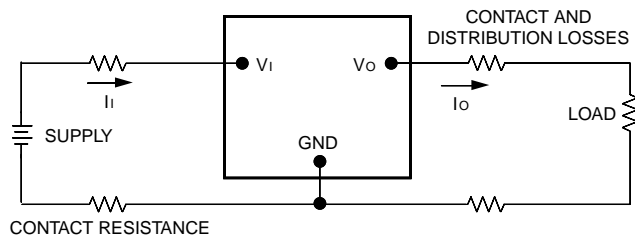
Note: Measure input reflected ripple current with a simulated source inductance ( $L_{TEST}$ ) of  $1\ \mu\text{H}$ . Capacitor CS offsets possible battery impedance. Measure current as shown above.

Figure 15. Input Reflected Ripple Current Test Setup.



Note: Scope measurements should be made using a BNC socket, with a  $10\ \mu\text{F}$  tantalum capacitor and a  $1\ \mu\text{F}$  ceramic capacitor. Position the load between 51 mm and 76 mm (2 in and 3 in) from the module

Figure 16. Peak-to-Peak Output Ripple Measurement Test Setup.



Note: All voltage measurements to be taken at the module terminals, as shown above. If sockets are used then Kelvin connections are required at the module terminals to avoid measurement errors due to socket contact resistance.

Figure 17. Output Voltage and Efficiency Test Setup.

$$\eta = \left( \frac{[V_{O(+)} - V_{O(-)}] \times I_O}{[V_{I(+)} - V_{I(-)}] \times I_I} \right) \times 100$$

## Design Considerations

### Input Source Impedance

To maintain low-noise and ripple at the input voltage, it is critical to use low ESR capacitors at the input to the module. 18 shows the input ripple voltage (mVp-p) for various output models using a  $150\ \mu\text{F}$  low ESR polymer capacitor (Panasonic p/n: EEFUE0J151R, Sanyo p/n: 6TPE150M) in parallel with  $47\ \mu\text{F}$  ceramic capacitor (Panasonic p/n: ECJ-5YB0J476M, Taiyo Yuden p/n: CEJMK432BJ476MMT). Figure 19 depicts much lower input voltage ripple when input capacitance is increased to  $450\ \mu\text{F}$  ( $3 \times 150\ \mu\text{F}$ ) polymer capacitors in parallel with  $94\ \mu\text{F}$  ( $2 \times 47\ \mu\text{F}$ ) ceramic capacitor.

The input capacitance should be able to handle an AC ripple current of at least:

$$I_{rms} = I_{out} \sqrt{\frac{V_{out}}{V_{in}} \left[ 1 - \frac{V_{out}}{V_{in}} \right]} A_{rms}$$

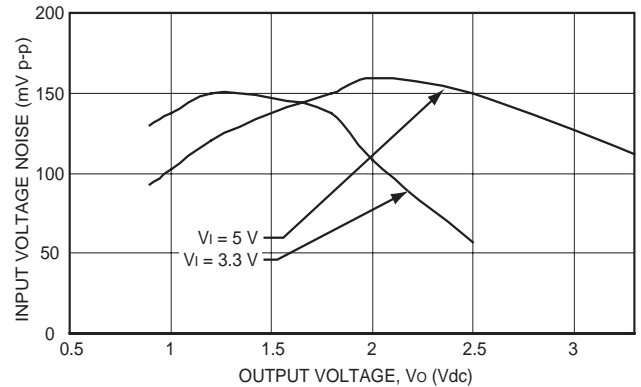


Figure 18. Input Voltage Ripple for Various Output Models,  $I_O = 10\ \text{A}$  ( $C_{IN} = 150\ \mu\text{F}$  polymer //  $47\ \mu\text{F}$  ceramic).

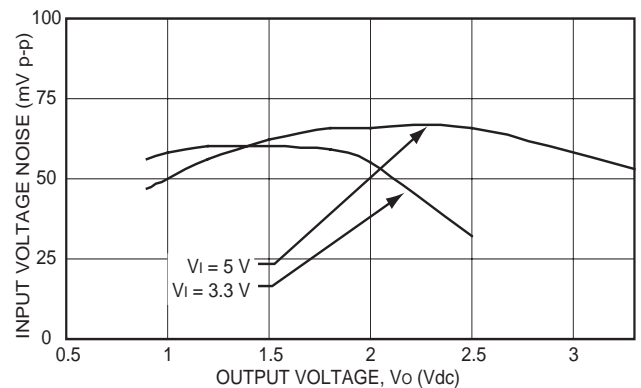


Figure 19. Input Voltage Ripple for Various Output Models,  $I_O = 10\ \text{A}$  ( $C_{IN} = 3 \times 150\ \mu\text{F}$  polymer //  $2 \times 47\ \mu\text{F}$  ceramic).



## Design Considerations (continued)

### Input Source Impedance (continued)

The power module should be connected to a low ac-impedance input source. Highly inductive source impedances can affect the stability of the module. An input capacitance must be placed close to the input pins of the module, to filter ripple current and ensure module stability in the presence of inductive traces that supply the input voltage to the module.

## Safety Considerations

For safety-agency approval of the system in which the power module is used, the power module must be installed in compliance with the spacing and separation requirements of the end-use safety agency standard, i.e., *UL60950*, *CSA C22.2 No. 60950-00*, and *VDE 0805:2001-12 (IEC60950, 3rd Ed)*.

For the converter output to be considered meeting the requirements of safety extra-low voltage (SELV), the input must meet SELV requirements.

The power module has ELV (extra-low voltage) outputs when all inputs are ELV.

The input to these units is to be provided with a maximum 20A time-delay fuse in the unearthed lead.

## Feature Descriptions

### Remote On/Off

The Austin Lynx™ SIP power modules feature an On/Off pin for remote On/Off operation. If not using the remote On/Off pin, leave the pin open (module will be On). The On/Off pin signal (Von/off) is referenced to ground. To switch the module on and off using remote On/Off, connect an open collector npn transistor between the On/Off pin and the VI pin (see Figure 20).

During a logic-low when the transistor is in the Off state, the power module is On and the maximum Von/off generated by the module is 0.3V. The maximum leakage current of the switch when Von/off = 0.3V and VI = 5.5V (Vswitch = 5.2V) is 10 µA. During a logic-high when the transistor is in the active state, the power module is Off. During this state, Von/off = 2.5V to 5.5V and the maximum Ion/off = 1mA.

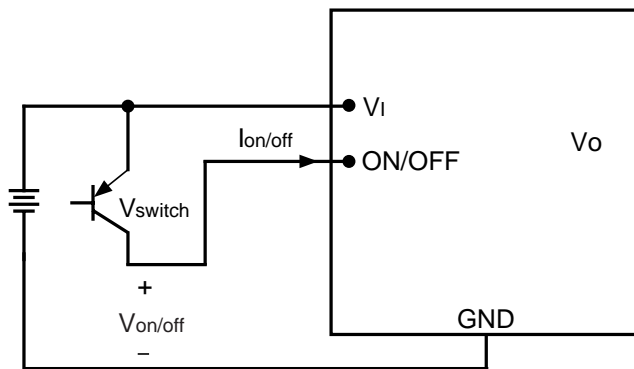


Figure 20. Remote On/Off Implementation.

### Output Voltage Set-Point Adjustment (Trim)

Output voltage set-point adjustment allows the output voltage set point to be increased or decreased by connecting either an external resistor or a voltage source between the TRIM pin and either the VO pin (decrease output voltage) or GND pin (increase output voltage).

For TRIM-UP using an external resistor, connect Rtrim-up between the TRIM and GND pins (Figure 21). The value of Rtrim-up defined as:

$$R_{\text{trim-up}} = \frac{24080}{|\Delta V_{\text{out}}|} - R_{\text{buffer}} \quad \text{k}\Omega$$

|DVout| is the desired output voltage set-point adjustment  
Rbuffer (internal to the module) is defined in Table 1 for various models.

Table 1. Austin Lynx™ Trim Values

VO, set	Rbuffer
3.3 V	59 kΩ
2.5 V	78.7 kΩ
2.0 V	100 kΩ
1.8 V	100 kΩ
1.5 V	100 kΩ
1.2 V	59 kΩ
1.0 V	30.1 kΩ
0.9 V	5.11 kΩ

Note: VO, set is the typical output voltage for the unit.

For example, to trim-up the output voltage of 1.5V module (AXH010A0M) by 8% to 1.62V, Rtrim-up is calculated as follows:

$$|\Delta V_{\text{out}}| = 0.12\text{V}$$

$$R_{\text{buffer}} = 100\text{k}\Omega$$

$$R_{\text{trim-up}} = \frac{24080}{0.12} - 100\text{k}$$

$$R_{\text{trim-up}} = 100.66\text{k}\Omega$$

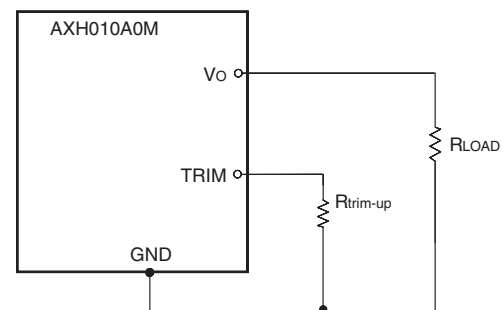


Figure 21. Circuit Configuration to trim-up output voltage.

For trim-down using an external resistor, connect Rtrim-down between the TRIM and VOUT pins of the module (Figure 22). The value of Rtrim-down is defined as:

$$R_{\text{trim-down}} = \left[ \left( \frac{V_{\text{out}} - 0.8}{|\Delta V_{\text{out}}|} - 1 \right) \times 30100 \right] - R_{\text{buffer}} \quad \text{k}\Omega$$

Vout is the typical set point voltage of a module  
|DVout| is the desired output voltage adjustment  
Rbuffer (internal to the module) is defined in Table 3 for various models

For example, to trim-down the output voltage of 2.5 V module (AXH010G) by 8% to 2.3V, Rtrim-down is calculated as follows:

$$|\Delta V_{\text{out}}| = 0.2\text{V}$$

$$V_{\text{out}} = 2.5\text{V}$$

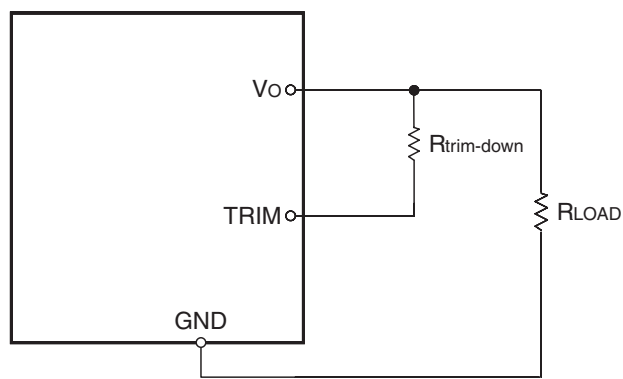
## Feature Descriptions (continued)

### Output Voltage Set-Point Adjustment (Trim) (continued)

$$R_{\text{buffer}} = 78.7\text{k}$$

$$R_{\text{trim-down}} = \left[ \left( \frac{2.5 - 0.8}{0.2} - 1 \right) \times 30100 \right] - 78700$$

$$R_{\text{trim-down}} = 147.05\text{k}\Omega$$



**Figure 22. Circuit Configuration to Decrease Output Voltage.**

For Trim-up using an external voltage source, apply a voltage from TRIM pin to ground using the following equation:

$$V_{\text{trim-up}} = 0.8 - \left[ |\Delta V_{\text{out}}| \times \frac{R_{\text{buffer}}}{30100} \right]$$

For Trim-down using an external voltage source, apply a voltage from TRIM pin to ground using the following equation:

$$V_{\text{trim-down}} = 0.8 + \left[ |\Delta V_{\text{out}}| \times \frac{R_{\text{buffer}}}{30100} \right]$$

$V_{\text{trim-up}}$  is the external source voltage for trim-up

$V_{\text{trim-down}}$  is the external source voltage for trim-down

$|\Delta V_{\text{out}}|$  is the desired output voltage set-point adjustment

$R_{\text{buffer}}$  (internal to the module) is defined in Table 3 for various models

If the TRIM feature is not being used, leave the TRIM pin disconnected.

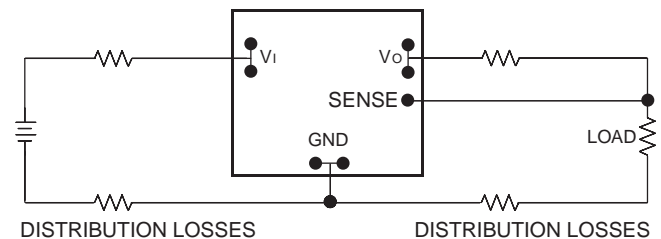
### Remote Sense

Austin Lynx™ SIP power modules offer an option for a Remote Sense function. When the Device Code description includes a suffix "3", pin 3 is added to the module and the Remote Sense is an active feature. See the Ordering Information at the end of this document for more information.

Remote Sense minimizes the effects of distribution losses by Lineage Power

regulating the voltage at the load via the SENSE and GND connections (See 23). The voltage between the SENSE pin and VO pin must not exceed 0.5V. Although both the Remote Sense and Trim features can each increase the output voltage (VO), the maximum increase is not the sum of both. The maximum VO increase is the larger of either the Remote Sense or the Trim.

The amount of power delivered by the module is defined as the output voltage multiplied by the output current (VO x IO). When using SENSE and/or TRIM, the output voltage of the module can increase which, if the same output current is maintained, increases the power output by the module. Make sure that the maximum output power of the module remains at or below the maximum rated power. When pin 3 is present but the Remote Sense feature is not being used, leave Sense pin disconnected.



**Figure 23. Effective Circuit Configuration for Remote Sense Operation.**

### Overcurrent Protection

To provide protection in a fault condition, the unit is equipped with internal overcurrent protection. The unit operates normally once the fault condition is removed.

The power module will supply up to 170% of rated current for less than 1.25 seconds before it enters thermal shutdown.

### Overtemperature Protection

To provide additional protection in a fault condition, the unit is equipped with a nonlatched thermal shutdown circuit. The shutdown circuit engages when Q1 or Q2 (shown in Figure 24) exceeds approximately 110 °C. The unit attempts to restart when Q1 or Q2 cool down and cycles on and off while the fault condition exists. Recovery from shutdown is accomplished when the cause of the overtemperature condition is removed.

## Thermal Considerations

The power module operates in a variety of thermal environments; however, sufficient cooling should be provided to help ensure reliable operation of the unit. Heat is removed by conduction, convection, and radiation to the surrounding environment.

The thermal data presented is based on measurements taken in a wind tunnel. The test setup shown in Figure 25 was used to collect data for Figures 26 and 27. Note that the airflow is parallel to the long axis of the module as shown in Figure 24 and derating applies accordingly.

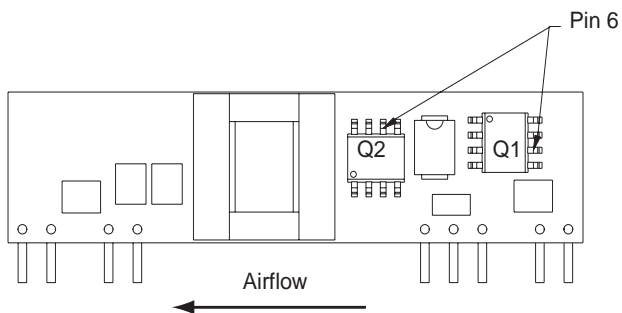


Figure 24. Temperature Measurement Location .

The temperature at either location should not exceed 110 °C. The output power of the module should not exceed the rated power for the module (VO, set x IO, max).

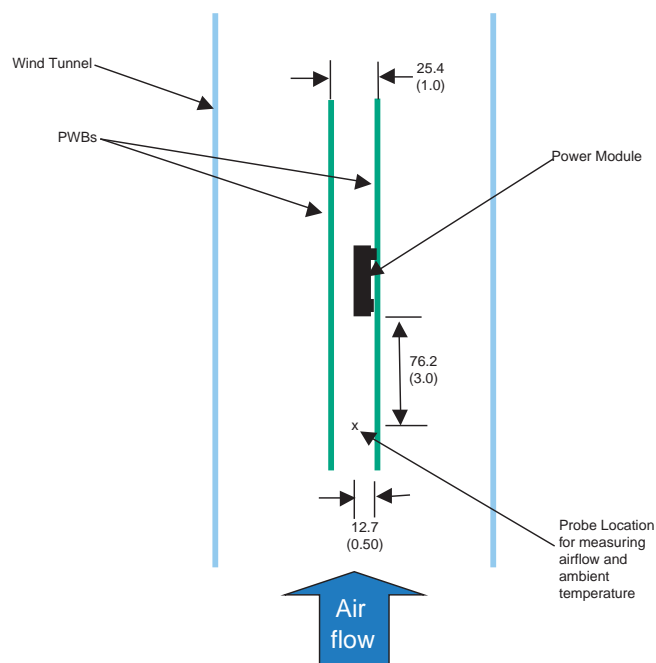


Figure 25. Thermal Test Setup.

## Convection Requirements for cooling

To predict the approximate cooling needed for the module, refer to the Power Derating curves in Figures 26 and 27.

These derating curves are approximations of the ambient temperatures and airflows required to keep the power module temperature below its maximum rating. Once the module is assembled in the actual system, the module's temperature should be checked as shown in Figure 24 to ensure it does not exceed 110 °C.

Proper cooling can be verified by measuring the power module's temperature at Q1-pin 6 and Q2-pin 6 as shown in Figure 24.

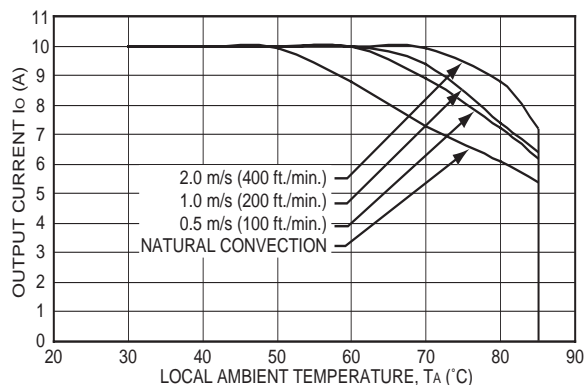


Figure 26. Typical Power Derating vs output Current for 3.3 Vin.

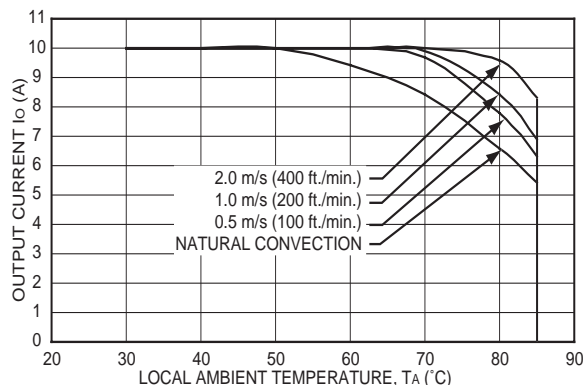


Figure 27. Typical Power Derating vs output Current for 5.0 Vin.

## Through-Hole Lead-Free Soldering Information

The RoHS-compliant through-hole products use the SAC (Sn/Ag/Cu) Pb-free solder and RoHS-compliant components. They are designed to be processed through single or dual wave soldering machines. The pins have an RoHS-compliant finish that is compatible with both Pb and Pb-free wave soldering processes. A maximum preheat rate of 3°C/s is suggested. The wave preheat process should be such that the temperature of the power module board is kept below 210°C. For Pb solder, the recommended pot temperature is 260°C, while the Pb-free solder pot is 270°C max. Not all RoHS-compliant through-hole products can be processed with paste-through-hole Pb or Pb-free reflow process. If additional information is needed, please consult with your Tyco Electronics Power System representative for more details.

## Post Solder Cleaning and Drying Considerations

Post solder cleaning is usually the final circuit-board assembly process prior to electrical board testing. The result of inadequate cleaning and drying can affect both the reliability of a power module and the testability of the finished circuit-board assembly. For guidance on appropriate soldering, cleaning and drying procedures, refer to Tyco Electronics *Board Mounted Power Modules: Soldering and Cleaning* Application Note (AP01-056EPS).

## Solder Ball and Cleanliness Requirements

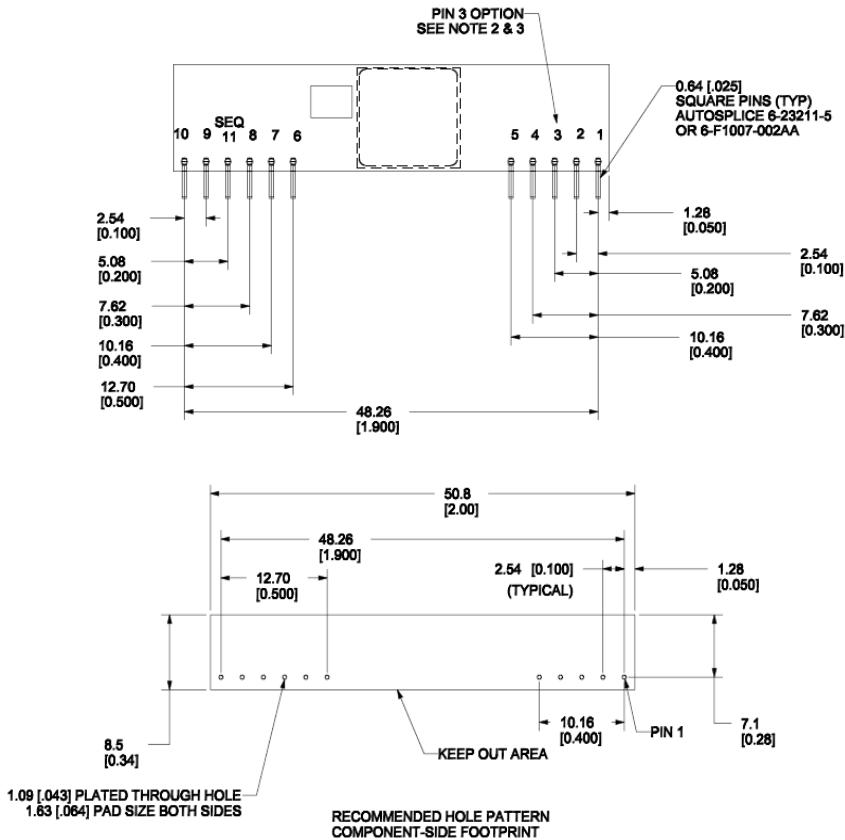
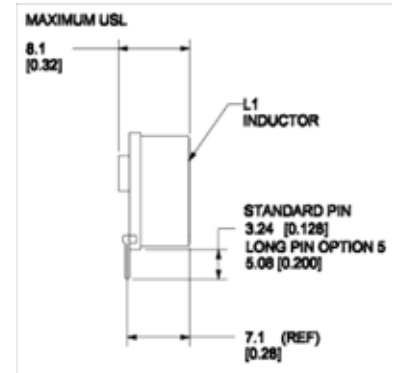
The open frame (no case or potting) power module will meet the solder ball requirements per J-STD-001B. These requirements state that solder balls must neither be loose nor violate the power module minimum electrical spacing.

The cleanliness designator of the open frame power module is C00 (per J specification).

## Outline Diagram for Through-Hole Module

Dimensions are in millimeters and (inches).

Tolerances: x.xx mm ± 0.5 mm (x.xx in. ± 0.02 in.) [unless otherwise indicated]  
x.xx mm ± 0.25 mm (x.xxx in. ± 0.010 in.)



PIN	FUNCTION	OPTION
1	V <sub>o</sub>	
2	V <sub>o</sub>	
3	V <sub>o</sub> SENSE	SEE NOTE 2&3
4	V <sub>o</sub>	
5	GND	
11	SEQUENCE	SEE NOTE 4
6	GND	
7	V <sub>i</sub>	
8	V <sub>i</sub>	
9	TRIM	
10	ON/OFF	

## Ordering Information

Please contact your Lineage Power Sales Representative for pricing, availability and optional features.

Input Voltage	Output Voltage	Output Current	Efficiency	Connector Type	Device Code	Comcodes
3.0 - 5.5 Vdc	0.9 V	10 A	83%	Through-Hole	AXH010A0S0R9	108966250
3.0 - 5.5 Vdc	1.0 V	10 A	85%	Through-Hole	AXH010A0S1R0	108966185
3.0 - 5.5 Vdc	1.2 V	10 A	86%	Through-Hole	AXH010A0P	108966235
3.0 - 5.5 Vdc	1.5 V	10 A	88%	Through-Hole	AXH010A0M	108966227
3.0 - 5.5 Vdc	1.8 V	10 A	90%	Through-Hole	AXH010A0Y	108966243
3.0 - 5.5 Vdc	2.0 V	10 A	91%	Through-Hole	AXH010A0D	108966193
3.0 - 5.5 Vdc	2.5 V	10 A	92%	Through-Hole	AXH010A0G	108966219
4.5 - 5.5 Vdc	3.3 V	10 A	95%	Through-Hole	AXH010A0F	108966201
3.0 - 5.5 Vdc	1.2 V	10 A	86%	Through-Hole	AXH010A0PZ	CC109106952
3.0 - 5.5 Vdc	1.5 V	10 A	88%	Through-Hole	AXH010A0MZ	CC109106936
3.0 - 5.5 Vdc	1.8 V	10 A	90%	Through-Hole	AXH010A0YZ	CC109101788
3.0 - 5.5 Vdc	2.0 V	10 A	91%	Through-Hole	AXH010A0DZ	CC109106845
3.0 - 5.5 Vdc	2.5 V	10 A	92%	Through-Hole	AXH010A0GZ	CC109101771
4.5 - 5.5 Vdc	3.3 V	10 A	95%	Through-Hole	AXH010A0FZ	CC109104898

Optional features can be ordered using the suffixes shown below. The suffixes follow the last letter of the Product Code and are placed in descending alphanumerical order.

**Table 2. Device Options**

Option	Suffix
Remote Sense	3
Long Pins: 5.08 mm ± 0.25 mm (0.20 in ± 0.010 in.)	5
RoHS Compliant	-Z



**World Wide Headquarters**  
**Lineage Power Corporation**  
 601 Shiloh Road, Plano, TX75074, USA  
**+1-800-526-7819**  
 (Outside U.S.A.: +1-972-244-9428)  
[www.lineagepower.com](http://www.lineagepower.com)  
**e-mail: techsupport1@lineagepower.com**

**Asia-Pacific Headquarters**  
 Tel: +65 641 6 4283

**Europe, Middle-East and Africa Headquarters**  
 Tel: +49 898 780 672 80

**India Headquarters**  
 Tel: +91 80 28411633

Lineage Power reserves the right to make changes to the product(s) or information contained herein without notice. No liability is assumed as a result of their use or application. No rights under any patent accompany the sale of any such product(s) or information.

Lineage Power DC-DC Products are protected under various patents. Information on these patents is available at [www.lineagepower.com/patents](http://www.lineagepower.com/patents)

© 2009 Lineage Power Corporation, (Plano, Texas) All International Rights Reserved.